

MAJORCOM:

GENERAL CATALOG 2024

EVAMATRIX

- SOUS TENSION
- SYSTÈME OK
- DÉRANGEMENT
- ALARME
- DÉFAUT SYSTÈME
- DÉFAUT MESSAGE
- ZONES HORS SERVICE
- DÉFAUT ALIMENTATION

MEMORY DISK

CONFIGURATION	CONFORT
MAJORCOM: BUZZER OFF	
SECURITE	MP3

MAJORCOM:

EXPERT IN
**PUBLIC ADDRESS AND
VOICE ALARM SYSTEMS**





MAJORCOM:

A story, a know-how

MAJORCOM, **founded 50 years ago** and based in Toulouse, is **the leading French company** and a major European player in the field of professional sound systems, public address and voice alarm..

MAJORCOM was the **first specialized company** in Voice Alarm systems **to be certified in France**. Through being at the forefront of the development of the most advanced technologies, MAJORCOM is committed to always providing products of the latest generation.

MAJORCOM mastery of production offers you the manufacturer's warranty on Public Address products and guarantees the compliance of its security systems with European EN 54 and International ISO standards.

A team, an expertise

MAJORCOM places **customer service at the heart of its business model** thanks to its dedicated business team.

Our systems are custom-designed by our engineering department which is staffed with acousticians and electronic engineers, with the expert support of our R&D department, and an after-sales department with highly involved support functions.

To our partners, we offer systems that are truly adapted to the reality of their technical needs and to the needs of the end users.



Values that stand the test of time

TO LISTEN AND WORK CLOSELY WITH OUR CUSTOMERS : we devote our full attention and expertise to **informing, securing and offering an outstanding customer experience**.

A FOCUS ON QUALITY : optimize your profitability rate thanks to **reliable systems supervised by our quality department** (Customer service < 0.3%).



A CULTURE OF INNOVATION : our systems feature every innovation that enhances **technical, energetic and connectivity performances**.

EXPERTISE : our engineering relies on innovative technical resources, on the **adaptability of our teams and their unconditional dedication to your projects to fully satisfy your every need**.

MAJORCOM:

A wide range of products and services

MAJORCOM provides expert advice, studies, estimates, editing, commissioning, maintenance and VAS quickly and efficiently on a selection of products from:

 <p>PUBLIC ADDRESS & IP SYSTEMS</p> <ul style="list-style-type: none"> • Sources & microphones • Mixers • Amplifiers • Audio over IP • Loudspeakers • PPMS, POI, PPI • Conference system • Induction loops... 	 <p>PROFESSIONAL SOUND SYSTEMS</p> <ul style="list-style-type: none"> • Line Array • Loudspeakers • Source • Processors • Amplifiers • Mixers • Accessories... 	 <p>VOICE ALARM SYSTEMS</p> <ul style="list-style-type: none"> • EN 54-16 Systems • Batteries & EN 54-4 Chargers • EN 54 Accessories • EN 54-24 Speakers
---	---	--

Our references

MAJORCOM has built its notoriety on the success of thousands of completed projects.

+ 50,000
On-site installations

+ 30,000
End customers





+ 1,000
Loyal installers

+ 100
Engineering consulting partners

Information at your disposal

To accompany you in the success of your projects.

 **TECHNICAL DOCUMENTATION**: check out our data sheets, application samples, videos and catalogues on our website: www.majorcom.fr

 **WEBSITE**: learn more about our services and products, accessible through any device, on our website: www.majorcom.fr

 **NEWSLETTER**: recommendations, innovations, invitations to trade shows... To keep up with all the MAJORCOM news, subscribe to our newsletter at www.majorcom.fr

VOICE ALARM SYSTEMS >

EN 54 4 EN 54 16 EN 54 24

VOICE ALARM SYSTEMS p. 5

EVAMATRIX system.....	p. 6	EN 54-24 speakers.....	p. 42
VULCA VOICE system.....	p. 38		

PUBLIC ADDRESS p. 71

PUBLIC ADDRESS Systems.....	p. 71	Gooseneck-shaped microphones.....	p. 227
Audio converters over IP network system.....	p. 72	Boundary microphone.....	p. 228
Network messages reader.....	p. 88	Wireless microphones.....	p. 229
Multi-zones broadcasting systems.....	p. 96	Source plates.....	p. 233
Conference system.....	p. 130	Interfaces.....	p. 240
Acoustic products.....	p. 141	Digital audio matrixes.....	p. 242
Omnidirectional speakers.....	p. 142	Analog audio matrixes.....	p. 248
Ceiling speakers.....	p. 144	Mixer amplifiers.....	p. 250
Wall-mount speakers.....	p. 158	Amps-preamps with integrable sources.....	p. 254
High definition speaker.....	p. 165	Analog amp-preamp.....	p. 256
Active speakers.....	p. 166	Preamplifier mixer.....	p. 259
Sound projectors.....	p. 167	Class-D digital amplifiers.....	p. 262
Bidirectional sound projectors.....	p. 172	Analog amplifiers.....	p. 267
Spherical speakers.....	p. 174	Network amplifiers.....	p. 270
Pendant speakers.....	p. 176	Convertors.....	p. 273
Column speakers.....	p. 179	IP Interface.....	p. 274
High efficiency sound projectors.....	p. 187	Amps control.....	p. 275
Horn speakers.....	p. 191	Speaker lines control.....	p. 276
Power loudspeakers.....	p. 194	Remote PA monitor.....	p. 278
Line Array.....	p. 200	Switches.....	p. 279
Active portable speaker.....	p. 203	Distributor.....	p. 285
100V-8Ω Transformer.....	p. 204	Charger and batteries.....	p. 286
Attenuators.....	p. 205	Intercom.....	p. 287
Speaker line measurement.....	p. 207	Induction loops.....	p. 300
Electronic products.....	p. 209	Racks.....	p. 315
Audio sources.....	p. 210	Racks accessories.....	p. 316
Messages readers.....	p. 214	100V to audio line level converter.....	p. 317
Mic stations.....	p. 217	Connection plates.....	p. 318
Handheld microphone.....	p. 226		

IP SPEAKERS p. 321

IP Speakers.....	p. 321
-------------------------	---------------

PROFESSIONAL SOUND p. 339

Line Array.....	p. 340	Acoustic limiters.....	p. 348
Power loudspeakers.....	p. 342	Power amplifiers.....	p. 354
Source.....	p. 344	Low impedance amps.....	p. 355
Audio signal processing.....	p. 345		



EVAMATRIX

NO NEED TO CHOOSE BETWEEN PUBLIC ADDRESS & VOICE ALARM SYSTEMS ANYMORE!

All-in-one sound and evacuation system with complete network integration

Dante® EN 54 16

Airports · Metro Stations · Hotels
Hospitals · Stadiums
Shopping malls

Exhibition parks
Educational establishments
Buildings and industrial sites
High-rise buildings



EVAMATRIX - A high-performance system, stable and secure

MAJORCOM is proud to present EVAMATRIX, its brand-new EN 54-16 certified PA sound and evacuation system, with cutting-edge technology and excellent audio quality in both modes of use. EVAMATRIX is very simple to use and allows for great operation flexibility with its touchscreen on the front-panel or via an intuitive multi-platform web browser and no software constraints (smartphone, tablet, PC, MAC).

EVAMATRIX is an economically advantageous system, fully connected for easy installation and integration. It uses Dante® technology with redundancy for seamless availability in both centralized and decentralized architecture.

MAJORCOM's more than 50 years of experience in the VA and PA sound industry has made it possible to offer such a high-quality system, which is extremely simple to install and configure using its very intuitive interface.

Dante®

A fully connected architecture

EN 54 16



EVAMATRIX Controller

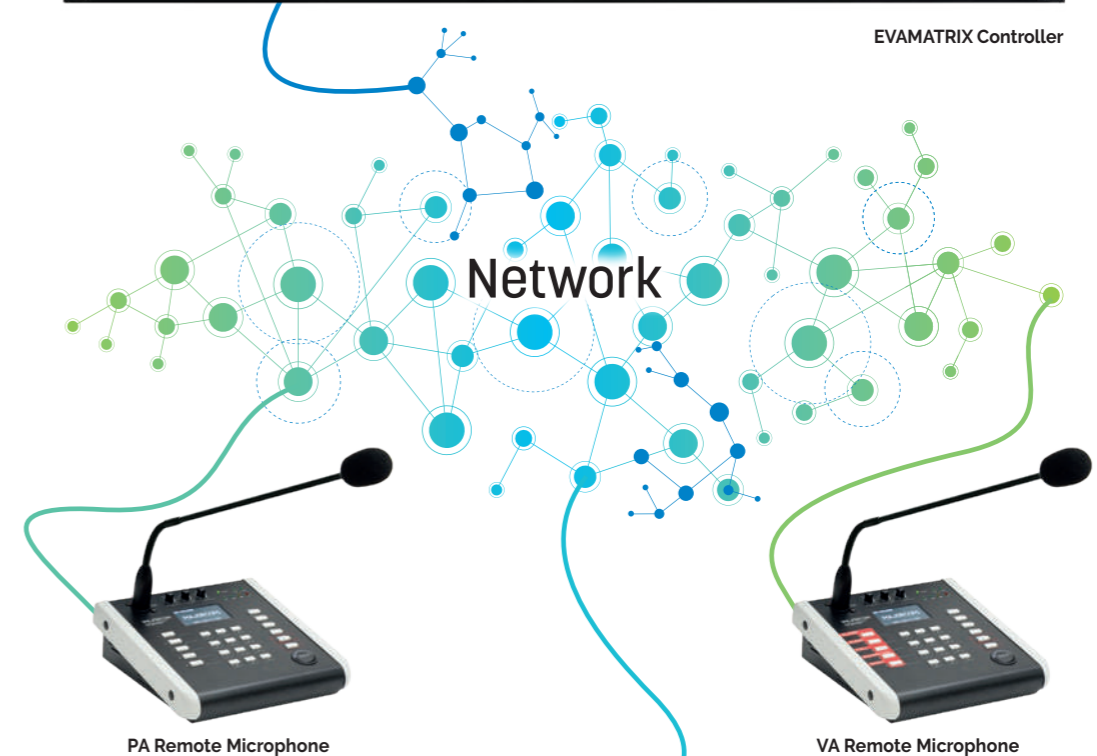

PA Remote Microphone

VA Remote Microphone

Connected digital amplifiers



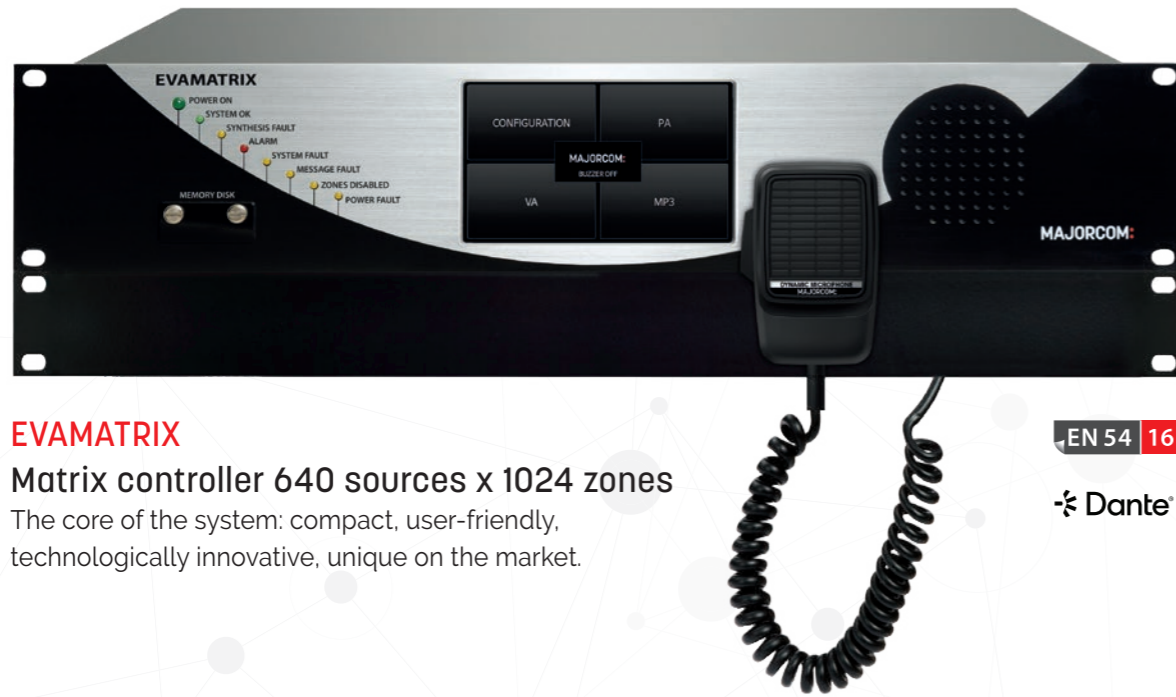

EVAMATRIX
Matrix controller 640 sources x 1024 zones
The core of the system: compact, user-friendly,
technologically innovative, unique on the market.

EN 54 16
Dante



PN Series
Connected digital amplifiers
Compact digital power from single to quadruple channel
DPN-240S: 1 x 240W • DPN-480S: 480W • DPN-240D: 2 x 240W
DPN-480D: 2 x 480W • DPN-240Q: 4 x 240W

Dante EN 54 16



RM-VA1000
PA & VA Remote Microphone
A secure source for excellent speech intelligibility.

Dante EN 54 16



EOL
End-of-line element
The reliable solution for controlling the integrity of
the 70V and 100V speaker line.

EN 54 16

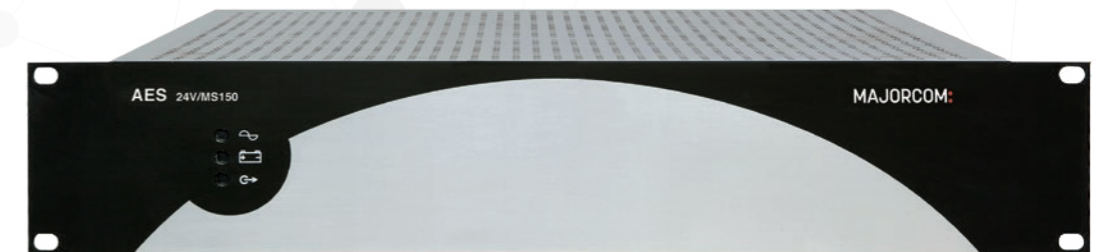

AES Series
EN 54-4 certified power supply units
AES 24V/MS40: Maximum current for all outputs = 40A
AES 24V/MS150: Maximum current for all outputs = 150A

EN 54 4

EVAMATRIX - A SAFE AND ECONOMICALLY ADVANTAGEOUS SYSTEM



256-bit security and encryption



Wiring and installation simplified through IP



Save time and money



Perfectly meets market demands and needs



Reduced installation costs and commissioning



Interfacing and multiple compatibilities including SNMP V2c

- An intuitive graphical interface for user comfort, with integrated security functions.
- A system with reduced operational and maintenance costs.
- Modern design with reduced power consumption, minimal heat loss and reduced rack congestion.

EVAMATRIX - A COMPLETE SYSTEM FOR ALL KINDS OF APPLICATIONS

EN 54-16 Certified	DANTE® & IP	1024 Zones 2048 speaker lines A+B	Control & Supervision	Progressive evacuation
Centralized management	Real-time supervision	Touchscreen GUI	Security & Encryption Https/SSL/ TLS1.2/ AES256	Web interface
Annual Scheduler	TTS : Text-to-Speech	Powerful event engine	Brid's Eye View SNMP and more	Connectivity Flexibility

EVAMATRIX - A COMPLETE SYSTEM FOR ALL KINDS OF APPLICATIONS

EN 54-16 certification

The EVAMATRIX system is EN 54-16 certified and can be installed in any rack in accordance with regulatory recommendations.

Dante® & IP

The EVAMATRIX system runs entirely over IP networks, providing full flexibility and optimal scalability, integrating the latest and most recognized technologies such as Dante®. The system can be easily deployed with both centralized and decentralized configuration. All components of the system offer redundant Gigabit Ethernet network connectivity that combines security and reliability.

1024 Zones / 2048 speaker lines A+B 512 alarm zones

The EVAMATRIX system is designed to handle 1024 PA zones and 2048 A+B speaker lines. It can also handle up to 512 alarm zones.

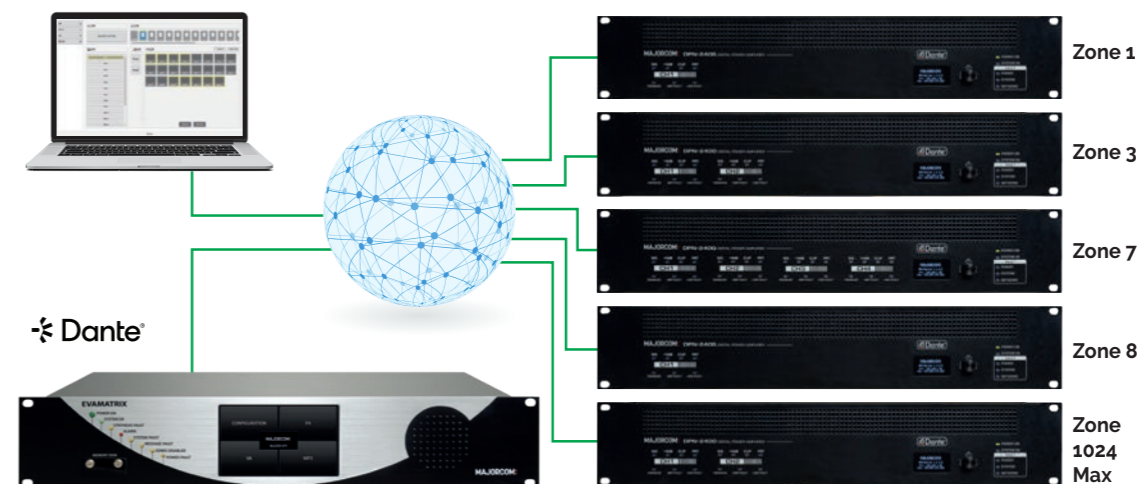

System control and supervision

EVAMATRIX is a system designed to deliver the best sound of PA and VA in one product. All system components are controlled in real time with indication and deferral of defects, for reliable and seamless supervision.

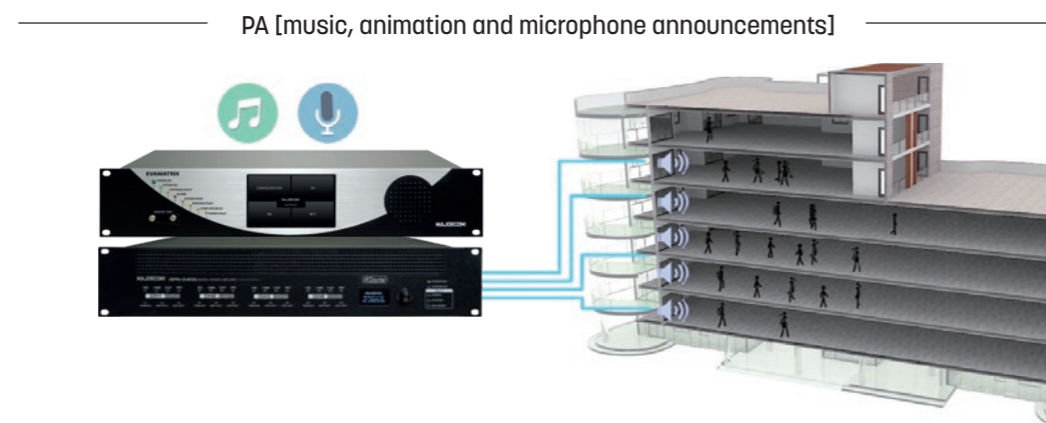

Progressive evacuation

EVAMATRIX is equipped with two security message readers that can be used to simultaneously broadcast the alarm message to one alarm zone group and a warning message to another alarm zone group. This allows an easier and gradual evacuation through CIE.

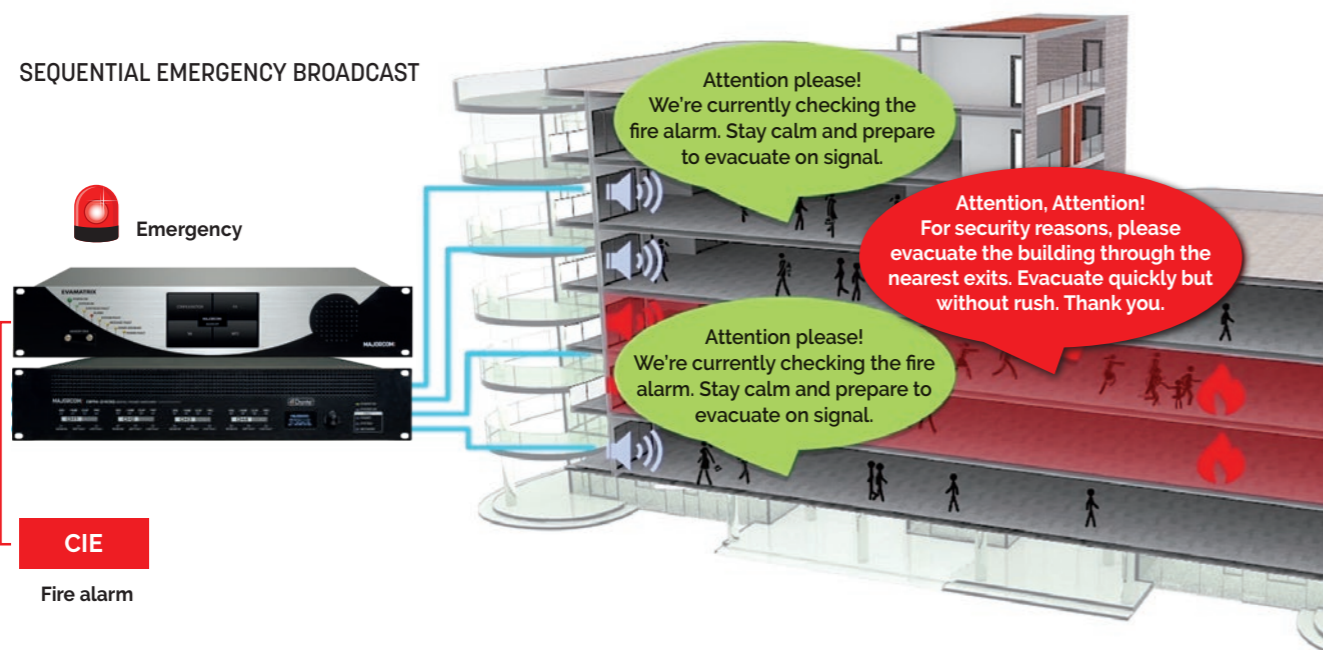

Centralized and remote management

With the EVAMATRIX system, it's never been easier to configure, set up, use and manage a comfort and evacuation sound system, whether your facility is located in a single site or decentralized.

EVAMATRIX doesn't require any heavy software or additional hardware, only a simple web browser from any PC, MAC or tablet.

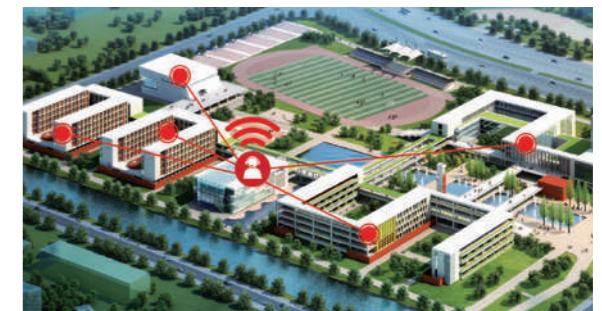

Control and Supervision Center

- The DPN amplifier series directly integrates speaker line control technology.
- Integrated DSP for sound processing.
- Additional connectivity: audio input, dry input/output, UGA

DPN Digital amplifiers

The DPN amplifier series offers a wide range of capacities and channels:

240 W, 2 x 240 W, 4 x 240 W, 480 W, 2 x 480 W.

Emergency amplifier management has been simplified. It is also possible to assign any amplifier channel as backup for one or more amplification units, and one or more channels can be dedicated as backup for the entire rack. This design saves energy and batteries, reduces heat emission and congestion in the bay.

Each amplifier channel has two independently monitored, controlled and protected speaker line outputs.

All DPN amplifiers offer a multitude of connections: alternate audio input, event inputs/outputs, UGA inputs and Gigabit Ethernet redundancy...

A DSP is embedded to allow all audio signal processing necessary for your facility.

Amplifier defect detection

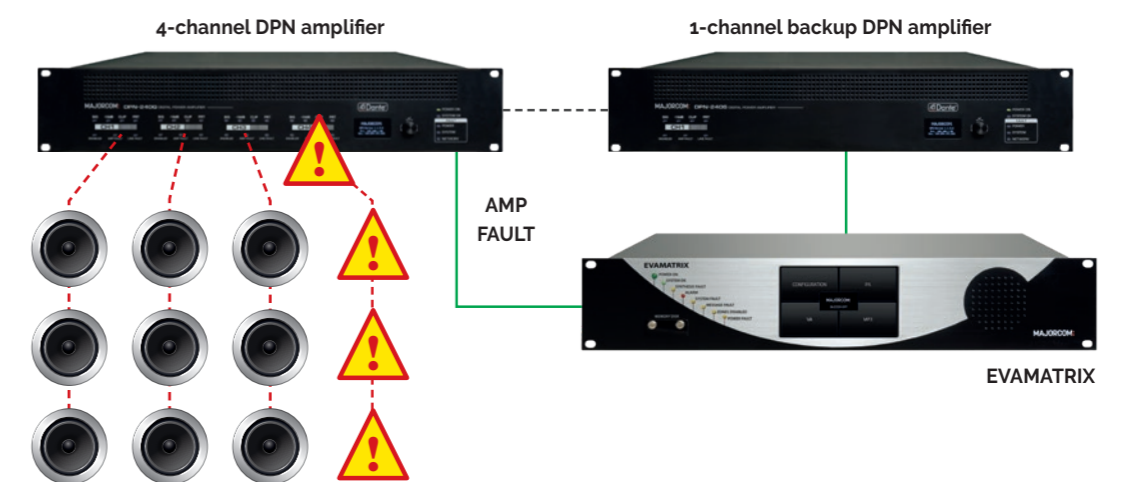

Real-time supervision

EVAMATRIX continuously controls and monitors all units and connections in the system, signals and audio streams, emergency functions, network redundancy, power supplies and speaker lines. Abnormalities and defects are detected in less than 100 seconds in accordance with relayed EN 54-16 standard. The detected defects are reported to the EVAMATRIX controller, recorded in the log files and relayed to the CIE fire alarm interface:

- Short circuit fault, line opening, impedance variation, earth fault below 50kΩ.
 - Power failure: emergency 54-4, 230VAC power supplies, AC/DC fuses.
 - Failure and monitoring of contact connections and UGA link interface to the CIE.
 - Amplifier Fault and backup amplifier auto-switching.
 - Evacuation memory disk fault and emergency function.
 - Failure of network connections with redundancy management.
 - Emergency PTT microphone and remote microphone fault.
- Etc...

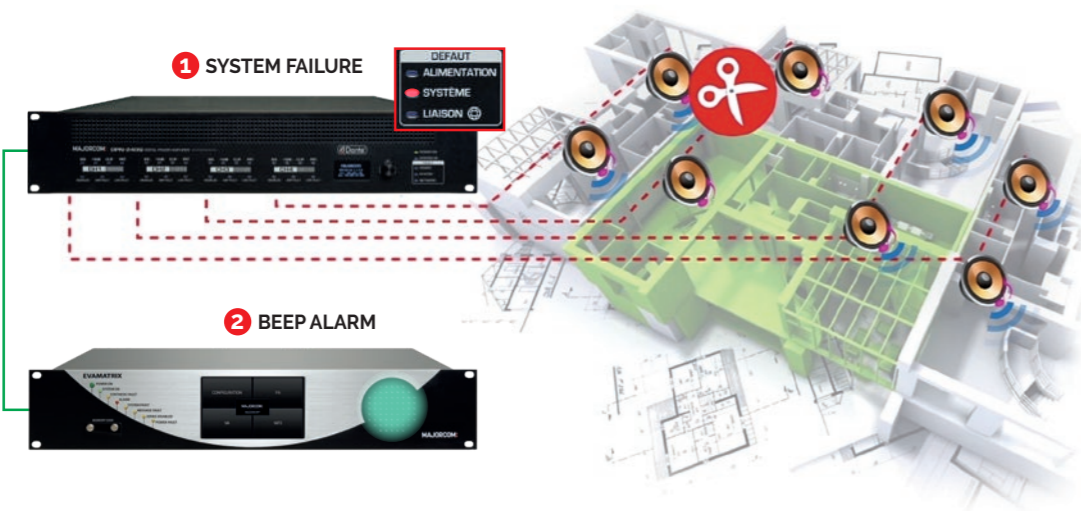

Monitor your VA System via SNMP

Thanks to the integration of the SNMP V3 (Simple Network Management Protocol) in the EVAMATRIX system, the status of sound equipment and all sorts of defects can be instantly detected and reported through a network monitoring and management software.

The functions supported by the SNMP protocol are:

- requesting and retrieving data,
- setting or writing data,
- SNMP alerts that signal the occurrence of events (speaker line fault, amplifier fault, CPU, alarm, etc.).

The SNMP protocol allows a management application (such as Centreon, PRTG for example) to request information from a managed unit (EVAMATRIX, DPN, RM) which is equipped with a software that sends and receives SNMP information called an SNMP agent.

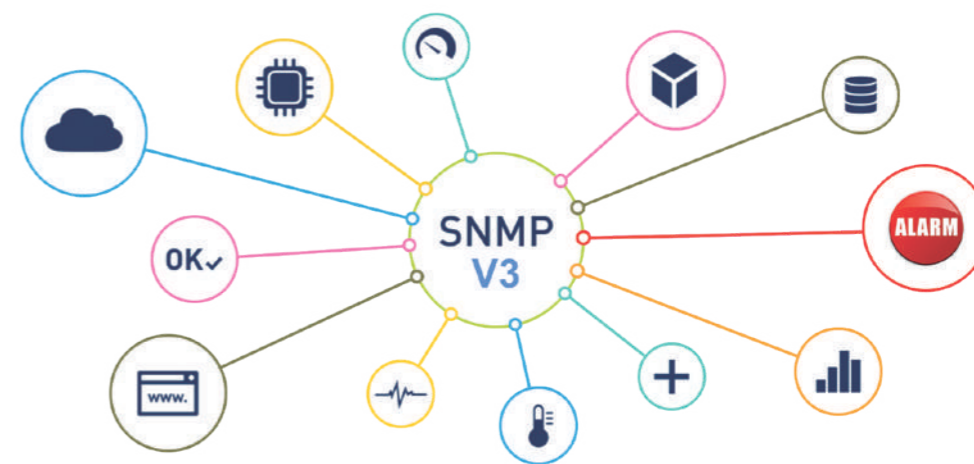

• EVAMATRIX components offer integrated network redundancy for complete security to compensate for any failure.

Seamless security

EVAMATRIX provides a secure user environment, protected from hacking. The data exchange is highly secure with 256-bit encryption. The accounts offer four levels of access to minimize confusion between different profiles.

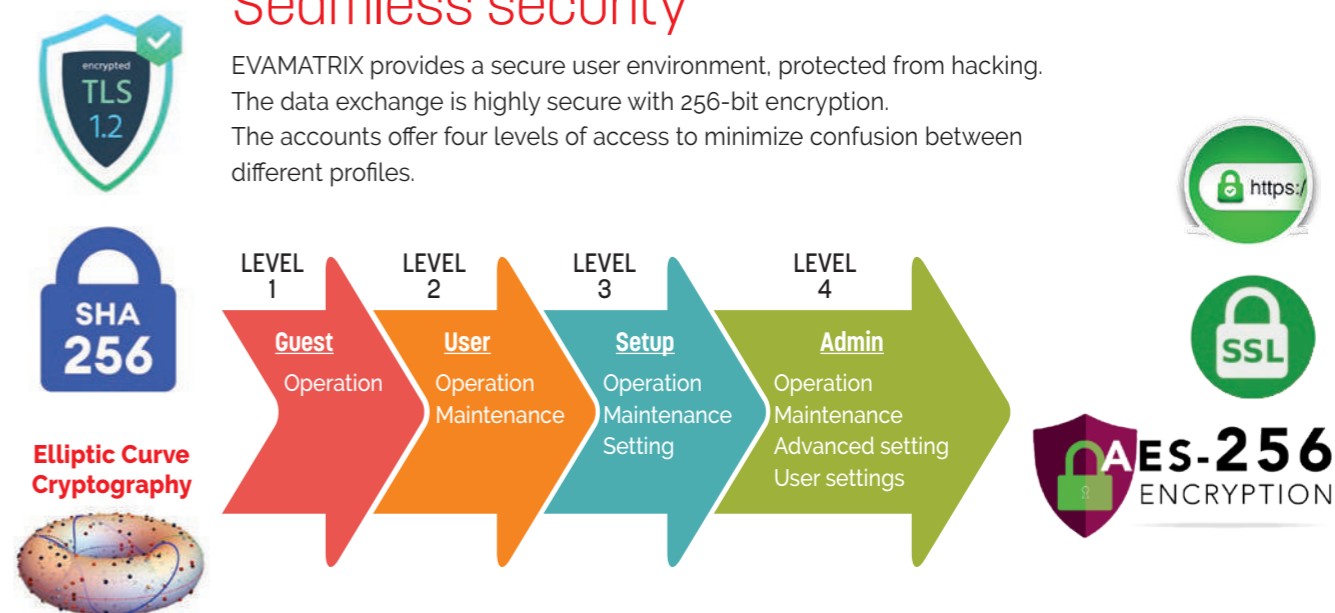

Touch interface GUI

The EVAMATRIX system can be easily managed and configured using the 5" color LCD touch-screen and its very intuitive navigation. All the selected functions and operator choices are highlighted and the status information is instantaneously displayed on-screen. Some functions are accessible according to access levels and permissions.

- Main screen: configuration, comfort, security, MP3.
- Configuration: language, network, system information, date & time.
- PA: source volume, area volume, preset, assignment and source routing.
- VA: reset, acquit, launch and stop alarm/alert, microphone and emergency call, faults, journal, test...
- MP3: PA MP3 player.

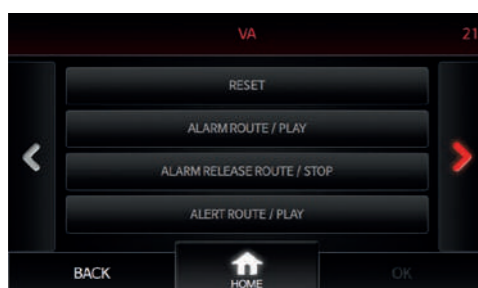
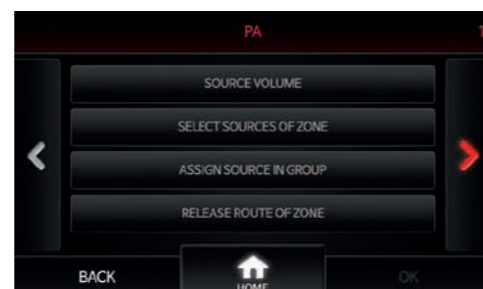
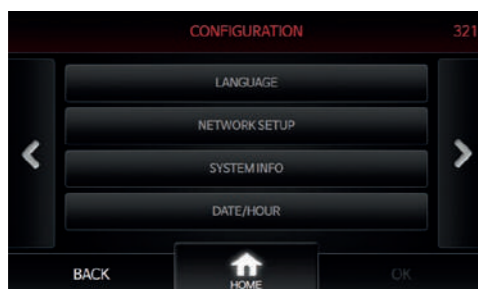
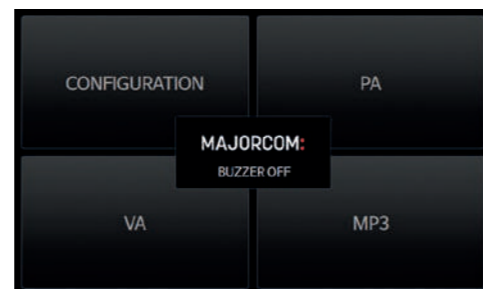

User-friendly, ergonomic and intuitive web interface

EVAMATRIX is the one and only system on the market that offers you in its standard version:

- a powerful annual event planner,
- a multilingual TTS engine,
- the "Bird's-Eye View" plan function.

Thus, EVAMATRIX can adapt to any type of installation without additional licensing and module costs.

Plain Interface for great simplicity of use

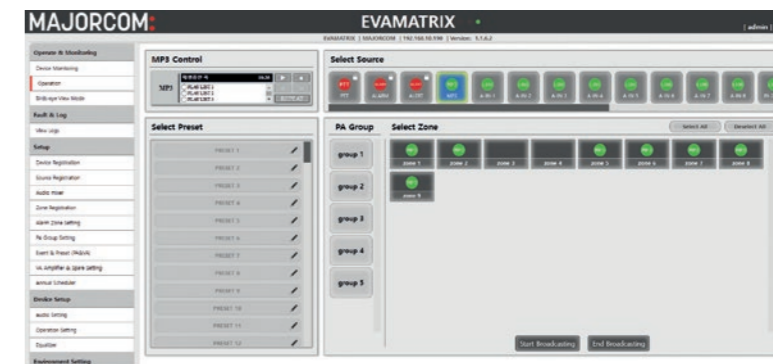

Annual Scheduler

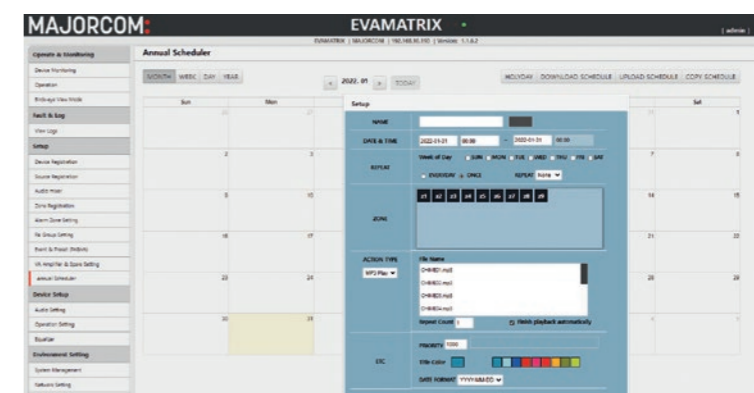

Vocal synthesis

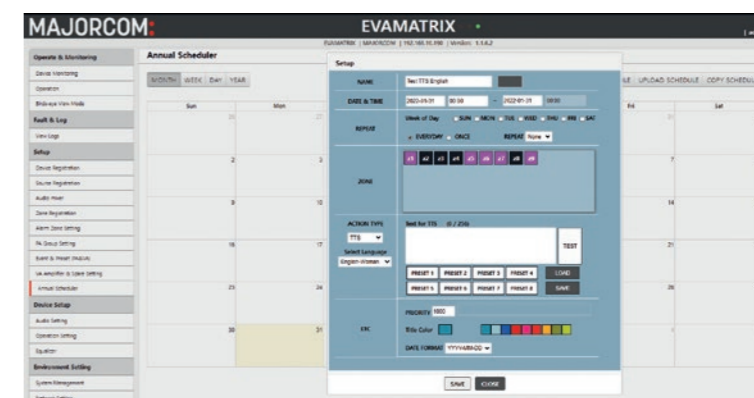

Plan mode



with multi-plan management



EVAMATRIX - MULTI-SITE APPLICATION

- EVAMATRIX 640 x 1024
- Dante® Network Audio Transmission
- Emergency system capable of detecting errors in the main signal and the line of communication in advance

— Audio [100V]
— Network

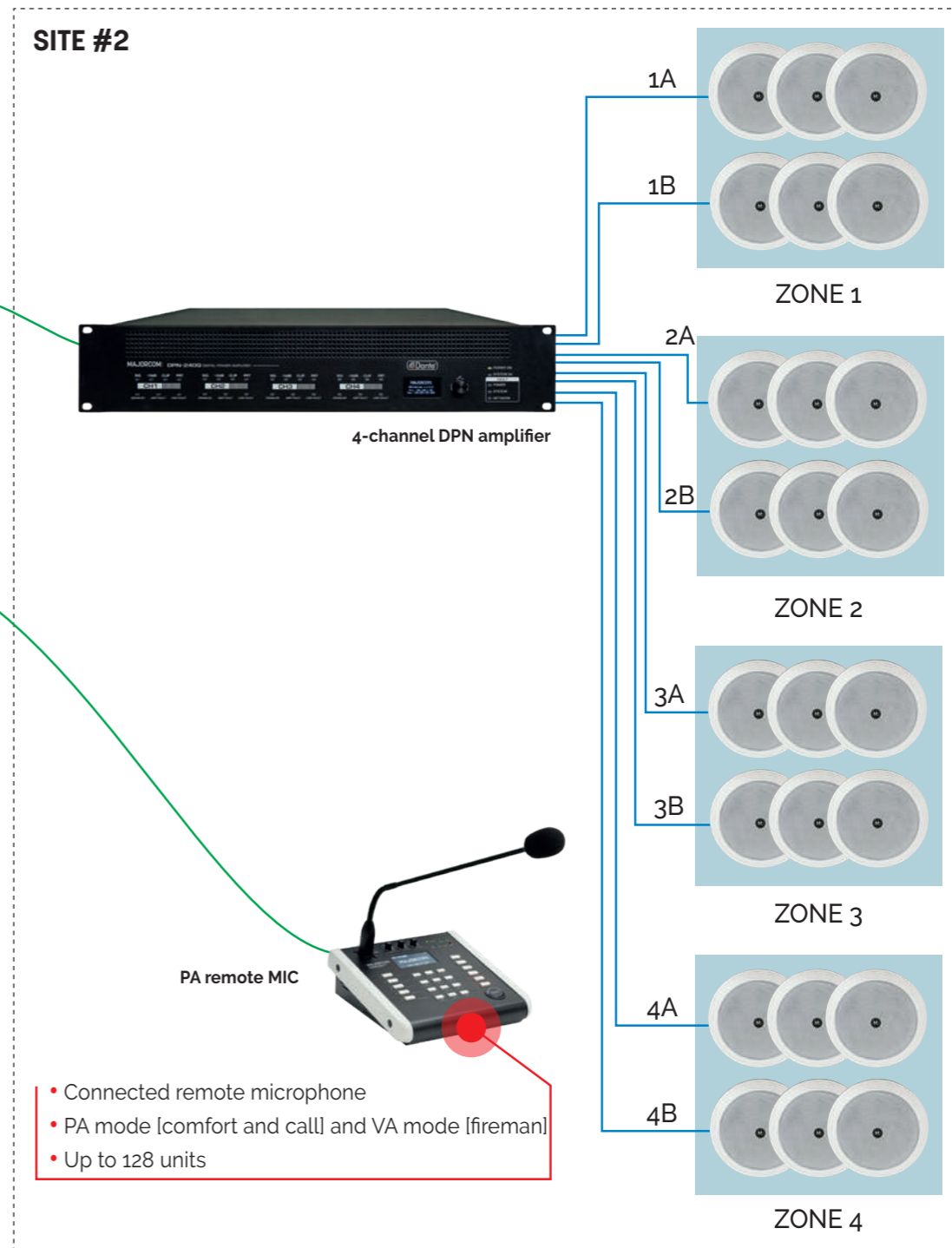
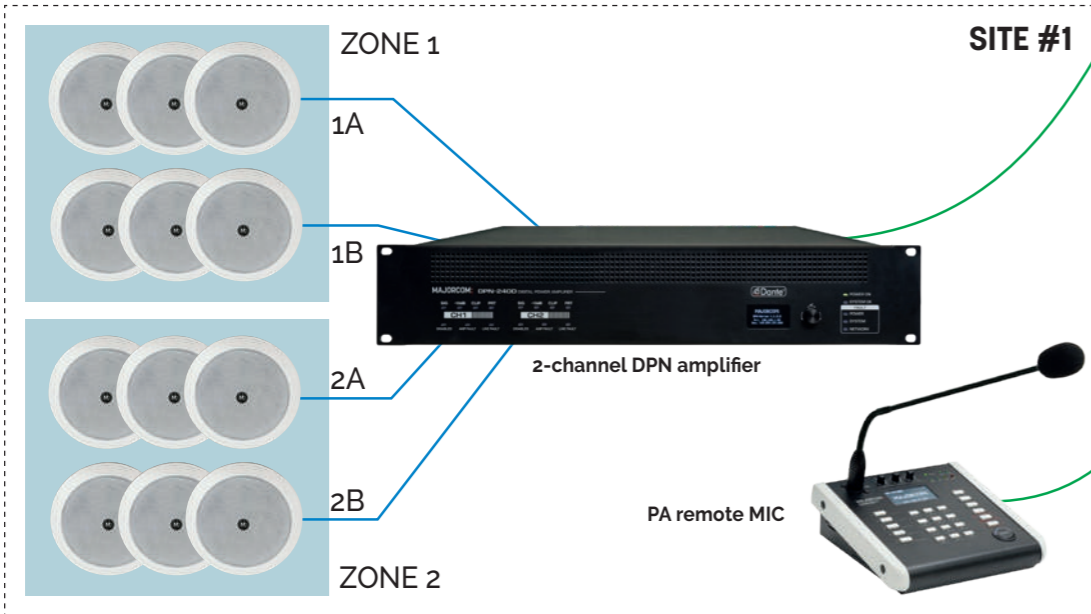
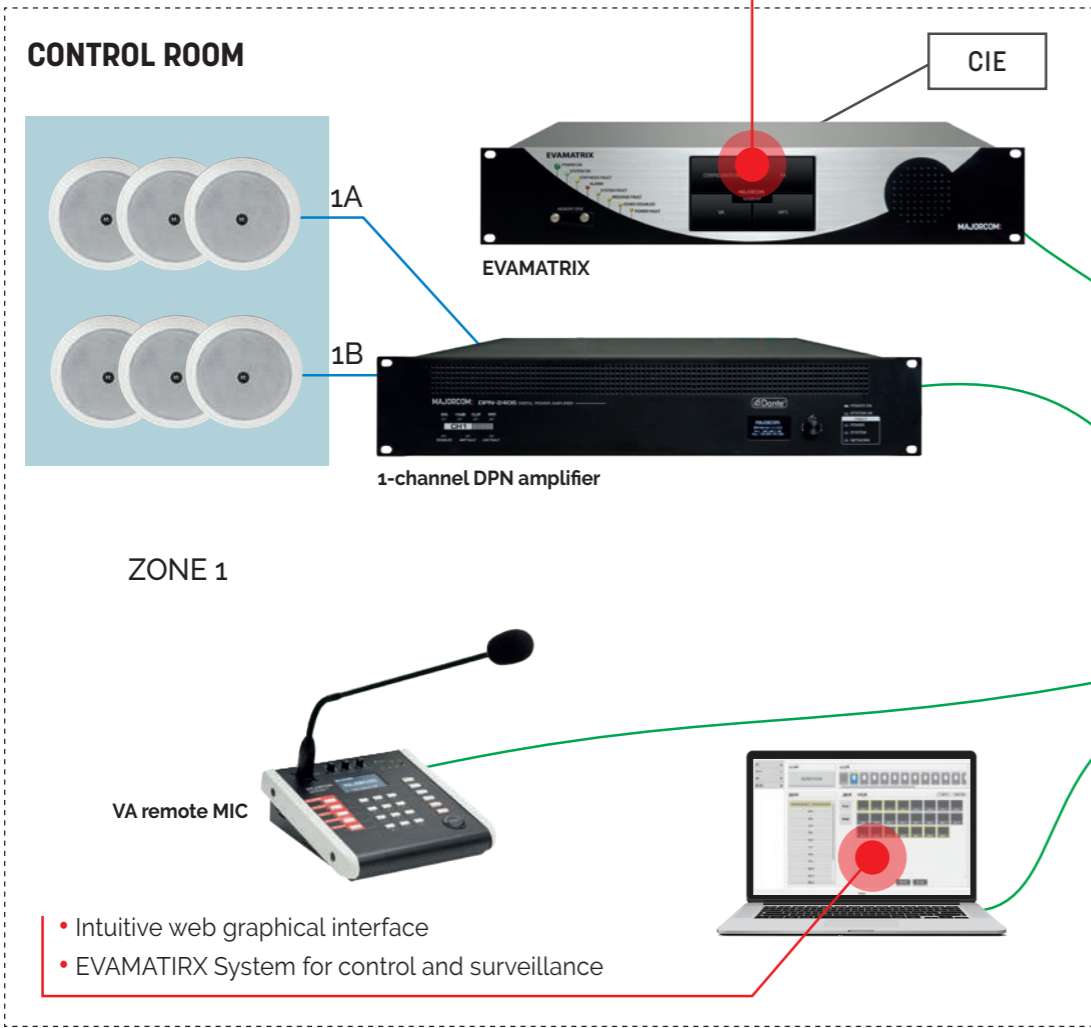

EN 54 16 : Optional functions with requirements

The EVAMATRIX system includes the following optional functions as well as their requirements in accordance with the EN 54-16 standard

OPTION	EN 54-16 SECTION/SUBSECTION	YES/NO	
Audible warning	7.3	Yes	✓
Delay(s) to entering the voice alarm condition	7.4	Yes	✓
Phased evacuation	7.5	Yes	✓
Manual silencing of the voice alarm condition	7.6.2	Yes	✓
Manual reset of the voice alarm condition	7.7.2	Yes	✓
Voice alarm conditions output	7.9	Yes	✓
Indication of faults related to voice alarm zones	8.4	Yes	✓
Disabled condition	9	Yes	✓
Voice alarm manual control	10	Yes	✓
Emergency microphone(s)	12	Yes	✓
Redundant power amplifiers	13.14	Yes	✓
Interface to external control device(s)	11	Yes	✓

EVAMATRIX Special Functions

- Redundant powerful amplifier
- PTT microphone and table
- Sound and visual indication
- Progressive evacuation
- Voice alarm delay and timing
- Stop the alarm while remaining in emergency mode
- Manual alarm reset
- Monitored and controlled fire alarm system output
- Voice alarm exit mode
- Manual voice alarm control
- Defect indication of the CIE communication protocol
- Indication of a malfunction related to the voice alarm zones
- External control device interface
- Annual scheduler
- TTS [Voice Synthesis]
- View with "Bird's-Eye View" plan
- Etc.

Backup power supply AES: a certified range

EN 54 4

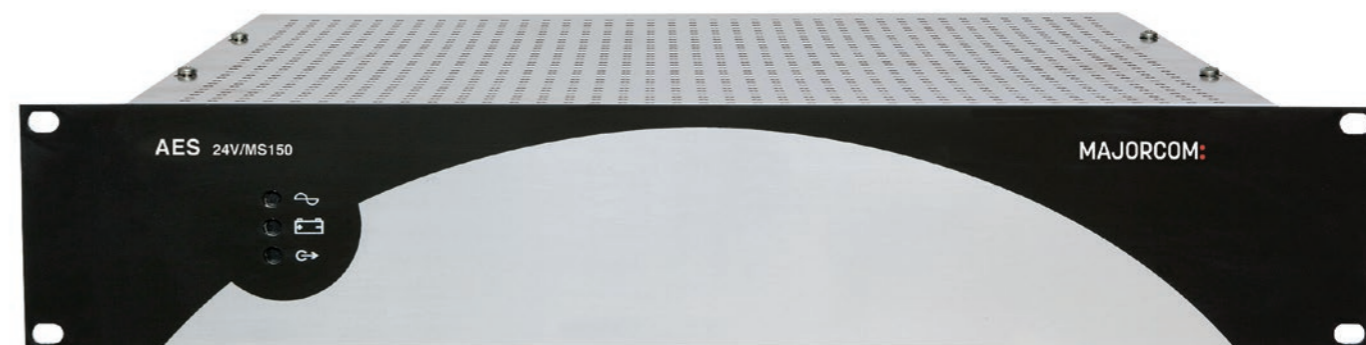

AES 24V/MS150

The EN 54-16 standard, which now governs Sound Security Systems (SSS), refers to the EN 54-4 standard according to which the different Power Supplies of our EVAMATRIX System are certified.

Our two BPS models comply with several EC directives: CPD (in compliance with EN 54-4/A2), LVD, EMC, WEEE and RoHS.

AES 24V/MS40: maximum current for all outputs is 40A.

AES 24V/MS150: maximum current for all outputs is 150A.



QUICK AND EASY TO SET UP

- **Simple:** all you need is "1 pair of pliers and 1 screwdriver".
- **Quick:** plug-in connectors on the rear panel. Ready-to-use connection kit.
- **Safe:** a totally sealed box prevents any risk of damaging the internal electronics due to falling conductive parts.
- **Light:** the weight of the 2U rack is 3.1kg for the AES 24V/MS40 and 5.4kg for the AES 24V/M150.

OPTIMAL PERFORMANCE

- **In normal operation mode:** the BPS power supply controls and recharges the batteries and keeps them charged from the power supply. It can provide the sound security system with standby current.
- **In security operation mode:** the total operating current (including the current of the amplifiers of the sound security system) is supplied by the batteries.

BACKUP BATTERIES

Stationary Batteries Sealed Lead Acid gas valve controlled by maintenance :

- 12V - 17Ah : **BAT12V17AH**
- 12V - 25Ah : **BAT12V25AH**
- 12V - 38Ah : **BAT12V38AH**
- 12V - 65Ah : **BAT12V65AH**
- 12V - 78Ah : **BAT12V78AH**
- 12V - 100Ah : **BAT12V100AH**
- 12V - 150Ah : **BAT12V150AH**
- 12V - 210Ah : **BAT12V210AH**



RACK 19" 12U EX / 22U EX / 32U EX / 37U EX / 42U EX : mounted

RACK 19" 12U EX CB / 22U EX CB / 32U EX CB / 37U EX CB / 42U EX CB : mounted, tested and wired



- 22U / 32U / 37U racks : removable side panels with key lock, front glass door & rear door with key lock.
- 12U / 42U racks : removable rear & side panels, front glass door with key lock.
- Supplied with fans, electrifications, wheels and brackets.

Model	RACK 19" 12U	RACK 19" 22U	RACK 19" 32U	RACK 19" 37U	RACK 19" 42U
Number of units	12	22	32	37	42
Dimensions (D x W x H with wheels)	600 x 600 x 722 mm	800 x 600 x 1169 mm	800 x 600 x 1613 mm	800 x 600 x 1835 mm	800 x 600 x 2074 mm
Number of fans	0	2	2	2	2
Color	RAL 9005				RAL 9004

COFFRET RM-VA : 4U Wall mounted rack for RM-VA 1000



- This 19" wall-mount cabinet allows the RM-VA 1000 voice alarm mic to be deported while maintaining access levels required by EN 54-16 standard.
- It can hold one RM-VA 1000 microphone.
- Front glass door with lock provided with 2 keys.
- Removable top and bottom panels, making it easier for cable entry.
- The RM-VA 1000 is sold separately.

19" solid blank panel

- Fills unused space in the rack.
- Improves cooling efficiency and optimizes airflow circulation.

Models	Height (U)	Dimensions (mm) W x D x H	Color	Material
PB 9100	1U	483 x 10 x 42	Black RAL9005	Cold rolled steel (SPCC)
PB 9200	2U	483 x 10 x 88		
PB 9300	3U	483 x 10 x 132		
PB 9400	4U	483 x 10 x 175		



PB 9100



PB 9400

19" fixed shelf

- Ideal for non-rackmount equipment.

Models	Rack depth	Dimensions (mm) W x D x H	Height (U)	Color	Material	Load capacity
PLATEAU RACK 600	600 mm	483 x 350 x 88	2U	Black RAL9005	Cold rolled steel (SPCC)	20 kg
PLATEAU RACK 800	800 mm	470 x 550 x 48	2U			90 kg



PLATEAU RACK 600

19" reinforced fixed shelf

- Fixed shelf with reinforcement for heavy loads, ideal for batteries

Models	Rack depth	Dimensions (mm) W x D x H	Height (U)	Color	Material	Load capacity
PLAT RENF BAT 600	600 mm	470 x 350 x 48	2U	Black RAL9005	Cold rolled steel (SPCC)	90 kg
PLATEAU RENF BAT	800 mm	483 x 550 x 43	1U			120 kg



PLAT RENF BAT 600

19" sliding shelf

- Ideal for non-rackmount equipment.

Models	Rack depth	Height (U)	Depth (mm)	Color	Material	Load capacity
PLAT GLISSIERE 2U	600 mm	2U	400	Black RAL9005	Cold rolled steel (SPCC)	20 kg
PLAT GLISSIERE 800	800 mm	1U	550			35 kg



PLAT GLISSIERE 800

19" lockable drawer with handle

- Ideal for storing and protecting documentation or sensitive material in the bay.
- Equipped with key lock and handle.
- Supplied with 2 keys.

Models	Rack depth	Dimensions (mm) W x D x H	Height (U)	Color	Material
TIROIR RGMT 2U	600 mm	483 x 350 x 89	2U	Black RAL9005	Cold rolled steel (SPCC)
TIROIR 2U RACK 800	800 mm	483 x 550 x 89			



TIROIR 2U RACK 800

Dante® 640 Sources x 1024 Zones Matrix Controller

EN 54 16



EVAMATRIX is the first networked public address system co-developed by MAJORCOM and INTER-M that can be used in both centralized and decentralized locations.

EVAMATRIX is a powerful and scalable EN 54-16 VA (Voice Alarm) and PA (Public Address) PA system for versatile PA configurations.

FEATURES

- Complete control of the EVAMATRIX system components and audio routing 640 Sources / 1024 Zones / 2048 speaker lines in A&B.
- A wide range of Class-D digital amplifiers, DPN range available in single or multi-channel and on network.
- Emergency PTT microphone monitored on the central, included.
- Supervised and integrated storage of ALARM & ALERT security message files on 2 drives.
- Support for Dante® and ana- logical audio input streams on EVAMATRIX, DPN and RM-VA 1000.
- A maximum of 128 networked microphone consoles RM-VA1000 (security and comfort).
- Redundant IP connections (Primary and Secondary) for audio and controls.
- Control and supervision of all system functions and faults. All data is centralized, reported and archived.
- Powerful DSP on the EVAMATRIX control unit and DPN amplifiers.
- MP3 player to play your audio contents on the SD card in the front panel of the EVAMATRIX.
- Automated announcements programmable by schedule (daily, weekly, yearly, vacations).
- Powerful multi-language and multi-channel TTS engine programmable by calendar.
- Bird's-eye view feature to import your shots in PNG or JPG to make your user experience more personalized.
- A wide choice of connections and interfaces with the CIE* (UGA inputs and monitored dry contact in inputs and outputs).
- Ergonomic and user-friendly interface with a 5" LCD capacitive touch screen.
- Multi-platform setup, management and control via web page (thin client) depending on the access level.
- Additional network security implemented using AES-256-bit encryption, with real-time authentication and audio over IP encryption against malicious attacks.
- Internal real-time clock for event scheduler; support for Network Time Protocol (NTP) with automatic daylight saving time (DST).
- Internal fault and event log.
- Integrated web server for configuration, parameterization and client use depending on the access level.
- The EVAMATRIX system integrates the SNMP V3 protocol (Simple Network Management Protocol) which allows a management and monitoring software to report any type of defect and status of the sound equipment.
- The EVAMATRIX system integrates seamless security (HTTPS, TLS1.2, SHA256, SSL, AES256 encryption and elliptic curve cryptography)

*Control and Indicating Equipment

Dante® 640 Sources x 1024 Zones Matrix Controller

EN 54 16

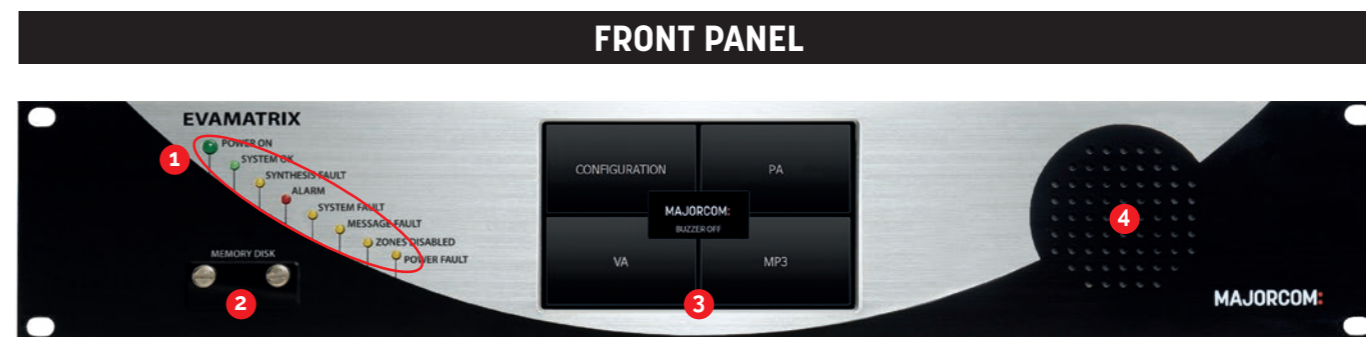

- 1 Status and fault LEDs
- 2 SD card slot (PA)
- 3 5" capacitive touch screen
- 4 Monitor speaker

REAR PANEL

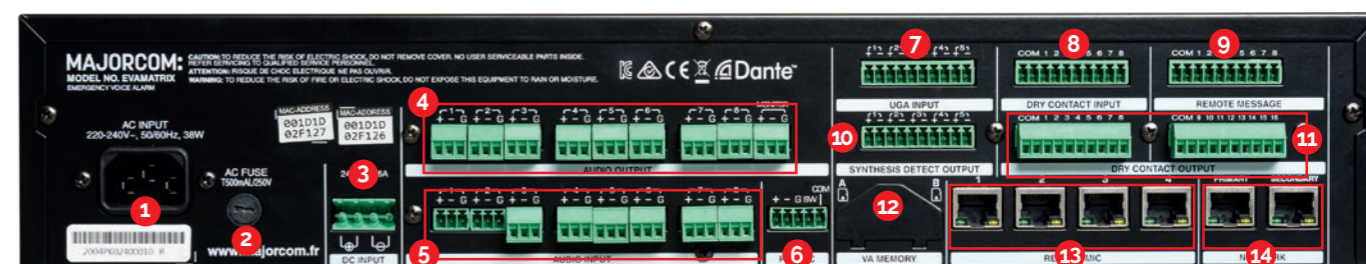

- 1 220VAC power outlet
- 2 Fuse 220VAC (T 0.5 A/250VAC)
- 3 24VDC power supply input (EAE backup)
- 4 PA audio outputs (1 ~ 8 & MONITOR)
- 5 PA audio inputs (1 ~ 8)
- 6 PTT microphone input on the front panel
- 7 UGA inputs (1 ~ 5) monitored Dry
- 8 Contact inputs (1 ~ 8) monitored
- 9 Trigger REMOTE MESSAGE (1 ~ 8) Fault
- 10 Synthesis outputs (1 ~ 5)
- 11 Dry contact outputs (1 ~ 16)
- 12 Monitored memory cards (security)
- 13 RJ-45 network ports - Dante® (Primary & Secondary)
- 14 RJ45 network ports RM-VA1000VA/PA Microphone Console (Dante® Primary)

EMERGENCY MICROPHONE PTT (PUSH TO TALK)

EN 54 16



- Push To Talk emergency microphone with microphone capsule monitoring
- Omnidirectional directionality

- 1 Microphone capsule 600Ω
- 2 Push button
- 3 Cable with 6-pin DIN connector

MODEL	MICRO PTT
Microphone	Dynamic capsule
Impedance	Omnidirectional
Sensitivity	-74dB @ 1kHz
Frequency response	300 to 5,000Hz
Dimensions (WxHxD)	50 x 90 x 45mm
Connector	DIN 6-pole lockable
Weight	210g
Sustainability	100.000 cycles
Standard	EN 54-16

Dante® 640 Sources x 1024 Zones Matrix Controller

EN 54 16

TECHNICAL CHARACTERISTICS

MODEL	EVAMATRIX	
Power supply	220 - 240VAC, 50/60Hz, 24VDC	
Consumption	Less than 38W	
Frequency response	20Hz - 20kHz (relative level @ 1kHz ±3dB)	
Signal to Noise Ratio	> 70dB	
Harmonic distortion rate (THD)	< 0.02%	
Gain adjustment per channel	-75dB ~ -0dB, about 0.4dB per 1 step	
DSP audio processing	48kHz, 32-bit CAN/CNA converters - DSP (294 MIPS)	
Virtual MATRIX	640 x 1024	
Audio inputs	MIC / PHANTOM MIC / LINE (1 ~ 8, Euroblock 3pins) Switchable 0dBV 10kΩ (LINE) / -60dBV 600Ω balanced (MIC) (with 24VDC Phantom power supply)	
Audio outputs	AUDIO OUT (1 ~ 8) 0dBV (balanced) Monitor 0dBV (balanced)	
Ethernet (LAN)	RJ45, TCP/IP protocol 10/100/1000 Base-T	
Extension (LAN)	Output to EVAMATRIX on RJ45 (Dante®) - Input from EVAMATRIX on RJ45 (Dante®) CAT5 cable Maximum distance: 100m	
PTT microphone	Supervised, 6-pin DIN connector	
UGA inputs	Inputs UGA 1 ~ 5: Triggering on a voltage Min/Max trigger voltage ALARM/ALERT: 21VDC to 60VDC UGA supervision: -3VDC + 3VDC	
Dry contact inputs	Inputs 1 ~ 8 10kΩ : in triggering 20 kΩ : in supervision Open or short-circuited: connection fault	REMOTE MESSAGE: 1 ~ 8 short-circuit triggerable
Dry contact outputs	Outputs 1 ~ 16 : relay outputs	
Synthesis output	Dry contact outputs 1 ~ 5 : relay output	
Protections	Current protection, temperature protection, voltage protection...	
MTTF availability	Average failure time greater than 100,000 hours	
MTTR availability	Average repair time less than 20 minutes	
DC input power supply	24VDC	
Touch screen	5"LCD	
Operating temperature	-10°C ~ +40°C - Humidity: 5 ~ 95%	
Weight	4.5kg	
Dimensions (WxHxD)	482 x 88 x 280mm (2U 19")	
Accessories	2x Micro SD / 1x SD Card / Euroblock Connectors / AC Power Cord / Micro PTT Cable / Screws / User Manual	
Protocol and security encryption	TCP/IP, Http, Https, SNMP V2c, IPv4, TLS1.2, SHA256, SSL, AES-256, Elliptic curve cryptography	

Dante® Digital Network Amplifiers

EN 54 16 DPN-240S · DPN-240D · DPN-240Q · DPN-480S · DPN-480D

FEATURES

- The DPN series offers a wide choice of single or multi-channel power ratings, in line 70V/100V with galvanic isolation.
- The amplifiers are EN 54-16 certified and designed to work with the EVAMATRIX security PA system.
- All system components are fully IP networked (audio & control) using Dante® technology.
- Dual primary and secondary network connection for total redundancy.
- Low power consumption, low heat dissipation for energy savings and gains in battery capacity and backup power.
- Complete supervision of the operation of the amplifiers and all connections. Faults are reported locally on the EVAMATRIX and archived.
- Control and supervision of the loudspeaker lines WITHOUT audio interruption with the EOL-20 end of line element
- Control and supervision of the network link with audible and visual indication on the amplifier unit and EVAMATRIX.
- Integrated backup amplifier channel dynamically assignable from the EVAMATRIX web interface with automatic switchover
- 2 A/B outputs on each amp channel. The 2 outputs are supervised and individually disabled in case of failure.
- Audio over IP, Dante® and AES67 compatible; audio sample rate is of 48kHz with a sample size of 24 bits.
- High signal to noise ratio, wide audio bandwidth, very low distortion and crosstalk.
- DSP, digital signal processing on all amp channels from the EVAMATRIX control unit web server, including equalization, levels to optimize and customize the sound in each speaker zone.



DPN-240S / 480S



DPN-240D / 480D



DPN-240Q

SEVERAL POWERS FROM SINGLE TO QUADRUPLE CHANNEL

1 x 240 W: DPN-240S 2 x 240 W: DPN-240D 4 x 240 W: DPN-240Q
1 x 480 W: DPN-480S 2 x 480 W: DPN-480D

- Local UGA and dry contact inputs monitored for triggering of alarm conditions, alarm... Ideal for decentralized systems.
- Dry contact inputs for local feedback of third party faults (CIE*, EAE, GTC...) in case of decentralized use.
- Local fault outputs customizable as desired and by alarm zone.
- An additional local analog audio input on each DPN amplifier that will be converted and made available to the entire EVAMATRIX system.
- The system integrates the SNMP V2c protocol (Simple Network Management Protocol) which allows a management and monitoring software to report any type of fault and status of the sound equipment.
- The system incorporates seamless security (HTTPS, TLS1.2, SHA256, SSL, AES256 encryption and elliptic curve cryptography).

*Control and Indicating Equipment

Dante Digital Network Amplifiers EN 54 16
DPN-240S · DPN-240D · DPN-240Q · DPN-480S · DPN-480D

Dante Digital Network Amplifiers EN 54 16
DPN-240S · DPN-240D · DPN-240Q · DPN-480S · DPN-480D

FRONT PANEL



- 1 Status LEDs: system, power, network LEDs
- 2 Audio signal level and protection
- 3 Status LEDs: amplifier fault, speaker line fault, zone out of order
- 4 OLED information display and control wheel

REAR PANEL



- 1 220VAC power outlet
- 2 24VDC power supply input (EAE backup)
- 3 AMP OUTPUT: A&B speaker line output terminal
- 4 100V input emergency amplifier
- 5 Fault IN : monitored and programmable drycontact inputs (e.g. EAE fault)
- 6 DRY CONTACT IN: monitored dry contact inputs and Programmable (e.g.: Alarm/Alerts...)
- 7 DRY CONTACT OUT: programmable dry contact outputs (e.g.: defect carry-over...)
- 8 UGA IN: monitored UGA inputs for alarm/alert triggering
- 9 Dante® Primary & Secondary Ethernet Ports
- 10 AUDIO IN: line level audio input
- 11 Air exhaust vent

TECHNICAL CHARACTERISTICS

MODEL	DPN-240S	DPN-240D	DPN-240Q	DPN-480S	DPN-480D
Power supply	220 - 240VAC, 50/60Hz, 24VDC				
Power	1 x 240W RMS @ 70V/100V Class D Load Min 41.6Ω, Capacity Min 0.01uF	2 x 240W RMS @ 70V/100V Class D Load Min 41.6Ω, Capacity Min 0.01uF	4 x 240W RMS @ 70V/100V Class D Load Min 41.6Ω, Capacity Min 0.01uF	1 x 480W RMS @ 70V/100V Class D Load Min 41.6Ω, Capacity Min 0.01uF	2 x 480W RMS @ 70V/100V Class D Load Min 41.6Ω, Capacity Min 0.01uF
Consumption	Max	313W	595W	1 254W	583W
	1/8 power	135W	140W	280W	135W
	Standby	58W	75W	89W	59W
Frequency response	20Hz - 20kHz to (±3dB @ 1W)				
Signal / Noise	> 91dB (20kHz LPF, A-WTD)				
T.H.D	< 0.45% at 1kHz Power rating				
Audio input	Type: Balanced Euro terminal / Input sensitivity: 5dBV (1.78 Vrms)				
Ethernet (LAN)	RJ45, TCP/IP protocol 100/1000 Base-T				
Extension	Output to EVAMATRIX on RJ45 (Dante®) - Input from EVAMATRIX on RJ45 (Dante®) CAT5 cable Maximum distance: 100m				
UGA inputs	UGA inputs 1 - 4 : triggerable on a voltage (22V ~ 60V)				
Dry contact inputs	Dry contact inputs from (1 - 4) : triggerable on dry contact NO/NF				
Dry contact outputs	Dry contact outputs from (1 - 4) : Relay output				
Speaker line outputs	4-pin connector, (1ch) for channels A+B				
Backup amplifier input	1 input per channel, for amplifier with equal power				
Protection	Current protection, temperature protection, DC voltage output protection, overload				
MTTF availability	Average failure time greater than 100,000 hours				
MTRR availability	Average repair time less than 20 minutes				
AES/EAE emergency power input	24VDC				
FAULT-IN input	Supervised fault input for remote fault reporting (e.g. AES/EAE)				
Screen	1.3" OLED screen				
Operating temperature	-10°C ~ +40°C / Humidity: 5 - 95%				
Weight	8,59kg	9,1kg	10,1kg	8,56kg	9,7kg
Dimensions (WxHxD)	482 x 88 x 450mm				
Accessories	AC power cord, Euroblock connectors, Rack mount screws, User manual				
Protocol and encryption	TCP/IP, Http, Https, SNMP V2c, IPv4, TLS1.2, SHA256, SSL, AES-256, Elliptic curve cryptography				



EN 54 16

Microphone Call Station for VA & PA

RM-VA 1000
VARM-VA 1000
PA

The RM-VA1000 call station is intended for use with EVAMATRIX VA or PA sound systems.

It can be configured in security mode (VA) via the supplied kit (sticker and rear cable protection cover) or in public address mode (PA).

It is easy to install and simple to use with its LCD screen that provides clear feedback on the configuration of a call.

The RM-VA 1000 only requires a connection to an IP network with a power supply via Ethernet 24VDC from EAE for use in or a simple 230VAC/24VDC adapter supplied for use in comfort mode.

In VA mode, the call station is fully supervised and allows you to launch an emergency call, ALARM, ALERT. The LCD screen gives the operator optimal control and constant feedback.

FEATURES

- The RM-VA1000 call station can be configured for VA or PA.
- Connection to the IP network via a shielded Cat5e cable
- The 2.3" LCD display (with function menu navigation key) provides instructions and comments during the emergency call process, pre-recorded messages (ALARM/ALERT).
- Built-in monitor speaker with volume control.
- Local audio line input (mono) for connecting an external audio source in comfort mode only. The audio channel is available on the network and can be assigned to any speaker zone.
- Up to 128 microphone consoles can be connected to the EVAMATRIX system, of which up to 4 are VA consoles.
- The call station is fully compliant with EN 54-16 standards for evacuation applications.
- All critical alarm functions are accessible according to access levels. The 2.3" display provides information on the system status.
- Control of all critical functions; signal and audio assignment is controlled, as well as communication with the network.
- The EVAMATRIX system integrates the SNMP V3 protocol (Simple Network Management Protocol) which allows a management and monitoring software to report any type of fault and status of the sound equipment.
- The EVAMATRIX system integrates seamless security (HTTPS, TLS1.2, SHA256, SSL, AES256 encryption and elliptic curve cryptography).



EN 54 16

Microphone Call Station for VA & PA

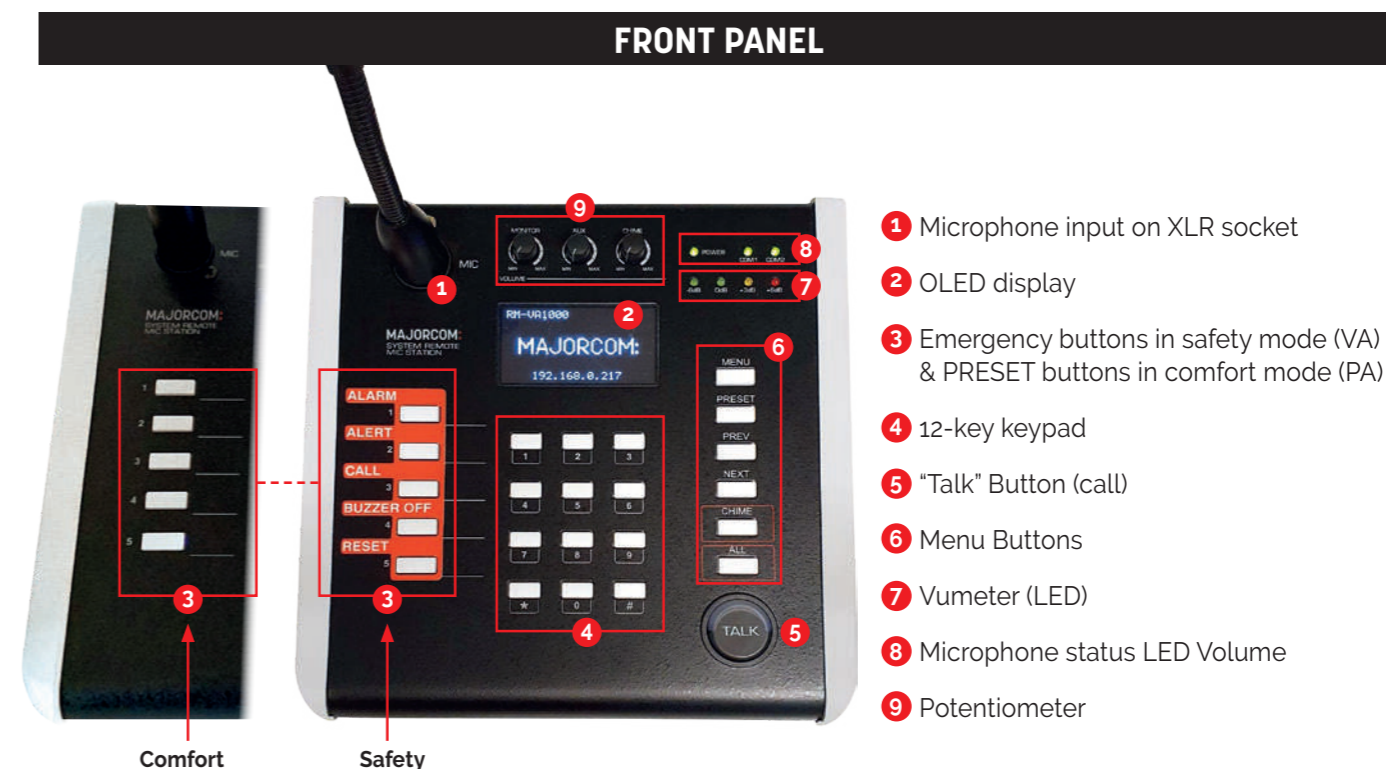

- Microphone input on XLR socket
- OLED display
- Emergency buttons in safety mode (VA) & PRESET buttons in comfort mode (PA)
- 12-key keypad
- "Talk" Button (call)
- Menu Buttons
- Vumeter (LED)
- Microphone status LED Volume
- Potentiometer

REAR PANEL



- 24VDC power connectors
- Reset switch
- RJ-45 network port
- AUX audio input jack (only in comfort mode)
- Mic input volume potentiometer

Safety mode cover
(VA)



Microphone Call Station for VA & PA

EN 54 16

TECHNICAL CHARACTERISTICS

MODEL	RM-VA 1000
Power supply	24VDC (VCC)
Consumption	Max. 10W
Frequency response	100Hz - 18kHz to -3dB @ 1kHz
Signal to Noise Ratio	> 65dB
Harmonic distortion rate (THD)	< 0,1%
MIC	
AUX input sensitivity	-50dBV
Output sensitivity	0dBV
Signal-to-noise ratio (< 20kHz LPF, A-WT.)	70dB or more
T.H.D (< 22kHz LPF)	0,1% or less
Frequency response 100Hz ~ 18kHz Input: -50dBV, 1kHz based	0dB ± 3dB
AUX	
AUX input sensitivity	-10dBV
Output sensitivity	0dBV
Signal-to-noise ratio (< 20kHz LPF, A-WT.)	80dB or more
T.H.D (< 22kHz LPF)	0,1% or less
Frequency response 100Hz ~ 18kHz Input: -50dBV, 1kHz based	0dB ± 3dB
General	
Ethernet (LAN)	RJ45, TCP/IP protocol 100/1000 Base-T
LAN Extension	Output to EVAMATRIX on RJ45 (Dante®) - Input from EVAMATRIX on RJ45 (Dante®) CAT5 cable Maximum distance: 100m
MTTF availability	Average failure time greater than 100,000 hours
MTTR availability	Average repair time less than 20 minutes
AES/EAE emergency power input	24VDC
OLED screen	2,42"
Operating temperature	-10°C ~ +40°C - Humidity: 5 ~ 95%
Weight	1,29kg
Dimensions (WxHxD)	200 x 73 x 206mm
Accessories	AC power cord, Adapter, Gooseneck microphone, Euroblock termina
Protocol and encryption	TCP/IP, Http, Https, SNMP V2c, IPv4, TLS1.2, SHA256, SSL, AES-256, Elliptic curve cryptography

End of line element

EOL-20

EN 54 16



This module is a reliable solution for checking the integrity of the loudspeaker line, which is mandatory for VA sound systems.

The EOL-20 is connected at the end of the line after the last speaker.

It communicates with the DPN amplifier channel that drives the speaker line to confirm the integrity of the speaker line.

Where impedance measurements may not detect a disconnected loudspeaker (depending on the number of loudspeakers and the type of cable), the EOL-20 provides a highly reliable solution to always report the correct status of the loudspeaker lines.

The EOL-20 housing is IP30 and fits most cable junction boxes.

FEATURES

- The operation is based on the detection of the amplifier's pilot signal with feedback to the amplifier via the same speaker line.
- No additional wiring is required for fault or status reporting.
- The end of line element must be connected at the end of the line and on each speaker line.
- The two wires have no polarity and can be connected in either direction.
- The A/B outputs of a DPN amplifier channel are individually supervised with separate end-of-line units.
- The switch allows a more accurate measurement of the loudspeaker line depending on its load:
 - HIGH: speaker line load greater than 150 W
 - LOW: speaker line load less than 150 W
- To reduce power consumption, the DPN amplifier channels use pilot signal modulation.
- The audibility of the pilot signal is practically zero due to the low amplitude of the pilot signal (20kHz frequency) which is far beyond the range of human-hearing, even in young children.

WIRING OF THE EOL-20 ON A SPEAKER LINE

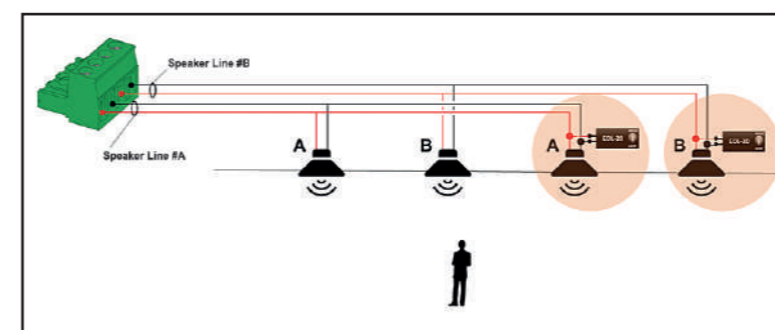

The EOL-20 must be connected at the end of the line and on each speaker line. The two wires have no polarity and can therefore be connected in either direction.

TECHNICAL CHARACTERISTICS

Model	EOL 20
Operating temperatures	-10°C ~ +40°C Humidity : 5 ~ 95%
LOW position	Speaker line load less than or equal to 150W
HIGH position	Loudspeaker line load greater than 150W
Weight	150g
Dimensions (WxHxD)	100 x 35 x 30mm
Accessories	no

SWCH EVA 8P+SFP M :**8-Port Gigabit Managed Industrial Ethernet Switch with 2 SFP ports****NEW**

SWCH EVA 8P+SFP M is a 10-port gigabit managed industrial Ethernet switch with 8 gigabit PoE RJ45 ports and 2 gigabit optical SFP ports. Each POE port can provide up to 30W and can be used for IEEE802.3af/at compatible Powered Devices (PDs). Supports dual DC power source backup.

**ALIM 24-48VDC 120W (NOT INCLUDED)****ISOLATED DC-DC POWER SUPPLY**

- Supplies power to the SWCH EVA 8P+SFP M by converting the 24V DC current supplied by the AES (AES24V MS40 or AES24V MS150) into 48V DC
- Easy DIN rail installation

TECHNICAL CHARACTERISTICS

General	SWCH EVA 8P+SFP M	
Network Interface	• 10/100/1000Mbps RJ45 ports x8 • 10/100/1000Mbps SFP ports x2	• Console ports x1
Network Protocol	IEEE802.3, IEEE802.3il, IEEE802.3u, IEEE802.3ab, IEEE802.3z, IEEE802.3ad, IEEE802.3x, IEEE802.3af/at, IEEE802.1p, IEEE802.1q, IEEE802.1w, IEEE802.1d, IEEE802.1s	
Performance	• Bandwidth : 20Gbps (Non-Block) • Throughput : 14.9Mpps • MAC table : 8K	• Port cache : 4.1Mb • Forwarding model : Store and forward
LED Indicator	• Power Indicator : P1,P2 • System Indicator : SYS • Alarm Indicator : ALM	• SFP Port Indicator : Link&Act F1-F2 • RJ45 Port Indicator : POE&Link&Act 1-8
POE Pin	1/2 (+), 3/6 (-)	
Casing	Corrugated high-strength metal housing, IP40	
Installation	DIN-Rail	
Dimensions (LxWxH)	163mm×110mm×46.5mm	
Operating Temperature	-40~75°C	
Storage Temperature	-40~85°C	
Operating Humidity	5%-95% RH (non-condensing)	
Storage Humidity	0%-95% RH (non-condensing)	
Certification	CE/ROHS/FCC	
Compliance	<ul style="list-style-type: none"> EMS : <ul style="list-style-type: none"> IEC61000-4-2 (ESD) : ±8kV (contact), ±15kV (air) IEC61000-4-3 (RS) : 10V/m (80MHz-2GHz) IEC61000-4-4 (EFT) : Power Port: ±4kV; Data Port: ±2kV IEC61000-4-5 (Surge) : Power Port: ±2kV/DM, ±4kV/CM; Data Port: ±6kV IEC61000-4-6 (CS) : 3V (10kHz-150kHz); 10V (150kHz-80MHz) IEC60068-2-6 (Vibration) 	<ul style="list-style-type: none"> IEC60068-2-27 (Shock) IEC60068-2-32 (Free Fall) EMC : <ul style="list-style-type: none"> EN IEC 61000-6-4:2019 EN IEC 61000-6-2:2019 EMI : <ul style="list-style-type: none"> FCC CFR47 Part 15 EN55022/CISPR22 Class A

Power supply	
Input voltage	48-56V DC (power supply not included, see ALIM 24-48VDC 120W)
Input port	Pluggable 5 pin terminals block, 5.08mm pitch (supports dual DC power source backup, built-in overcurrent protection, supports anti-reverse connection)
No-load power	6W@52V DC
Full load power	246W@52V DC (POE full load output)
Max. power for single port	30W
Software	
Protocol	<ul style="list-style-type: none"> IEEE 802.3 : Ethernet Media Access Control (MAC) IEEE 802.3i : 10BASE-T Ethernet IEEE 802.3u : 100BASE-TX fast Ethernet IEEE 802.3ab : 1000BASE-T gigabit Ethernet IEEE 802.3z : 1000BASE-X gigabit Ethernet(fiber) IEEE 802.3ad : Comply link aggregation standard IEEE 802.3x : Flow control IEEE 802.1p : About the traffic priority of the second layer of Qos / Cos protocol (multicast filtering) IEEE 802.1q : VLAN Bridge operation IEEE 802.1d : STP spanning tree IEEE 802.1s : MSTP spanning tree IEEE 802.1w : RSTP spanning tree IEEE 802.3af IEEE 802.3at
AI Button	<ul style="list-style-type: none"> AI Loop Protect AI PoE AI VLAN AI Extend
DHCP	DHCP Snooping
VLAN	<ul style="list-style-type: none"> 4K VLAN 802.1Q VLAN/MAC VLAN ,IP VLAN Voice VLAN
MAC Table	<ul style="list-style-type: none"> IEEE 802.1d Supports MAC address automatic learning and aging Support static, dynamic, filtering address table
Security	<ul style="list-style-type: none"> Password protection Decline user access by port number, IP address and MAC address HTTPS, SSL V3, TLS V1, SSH V1/V2 ARP Protection, IP source Protection, DoS Protection Supports DHCP Snooping and DHCP attack protection Supports 802.1X authentication, AAA Supports port security, port isolation Supports CPU protection Supports IP-MAC-PORT ternary binding
PoE Management	<ul style="list-style-type: none"> Supports PoE total power limit Supports PoE chip status view Supports PoE port priority setting Supports PoE power time period setting
ACL	<ul style="list-style-type: none"> Supports L2 (Layer 2) ~ L4 (Layer 4) packet filtering function Supports port mirroring, port redirection, flow rate limit, QoS remarking
QoS	<ul style="list-style-type: none"> Supports 8 port queues Supports port priority, 802.1P priority, DSCP priority Supports SP, RR, WRR, priority scheduling algorithm
Spanning Tree	<ul style="list-style-type: none"> Supports STP (IEEE 802.1d) RSTP (IEEE 802.1w) and MSTP (IEEE 802.1s) Supports loop protection, root bridge protection, TC protection, BPDU protection, BPDU filtering
Multicast	<ul style="list-style-type: none"> Supports IGMP v1/v2 Snooping Supports multicast VLAN Supports multicast filtering, packet statistics, and unknown multicast discards
Storm Suppression	<ul style="list-style-type: none"> Multicast suppression Broadcast suppression Unknown unicast suppression
Link Aggregation	<ul style="list-style-type: none"> Static aggregation Dynamic aggregation Supports IP, MAC, and hybrid load balancing modes Up to 32 aggregation groups
IPv6	Pv6 Ping, IPv6 Tracert, IPv6 Telnet, IPv6 SSH, IPv6 SSL
Management and Maintenance	<ul style="list-style-type: none"> WEB management HTTP/HTTPS V3 CLITelnet, SSH V1/V2, Local serial port SNMP V1/V2/V3 LLDP, RMON CPU monitoring, memory monitoring System log, grading warning Supports Ping, Tracert detection, cable detection ARP protection, IP source protection, DoS protection



(1): LED Power Default

(2): LED Battery Default

(3): LED Output Voltage Default

Model	AES 24V/MS 40	AES 24V/MS 150
Power voltage	195 - 264VAC, 50-60Hz	
Primary Current	1A @ 195VAC	2A @ 195VAC
	Breaker Circuit (D curve) need to be provided Upstream	
Outputs	Nominal Voltage 24VDC Floating Voltage Set at half-load and at 25°C: 27.2V +/- 0.5%	
	2 "Amplifiers" Outputs with a current of 20A maximum per Output on connectors 16mm ² 2 "Controllers" Outputs with a current of 5A maximum per Output on connectors 2.5mm ² The maximum current for all outputs is 40A	6 "Amplifiers" Outputs with a current of 40A maximum per Output on connectors 16mm ² 3 "Controllers" Outputs with a current of 5A maximum per Output on connectors 2.5mm ² The maximum current for all outputs is 150A
Outputs Relays	Output Relay without any voltage Battery Default Output Relay without any voltage Main Power Default Output Relay without any voltage 24V Output Default	
Battery Capacity	Between 24 and 110Ah	Between 38 and 225Ah
Operating Temperature	-10 to +45°C at 100% of load -10 to +55°C at 75% of load	
Relative Humidity	20 to 95%	
Dimensions (W x D x H)	483 x 395 x 89mm	
Weight	3.1kg	5.4kg



AES 24V/MS40 rear panel

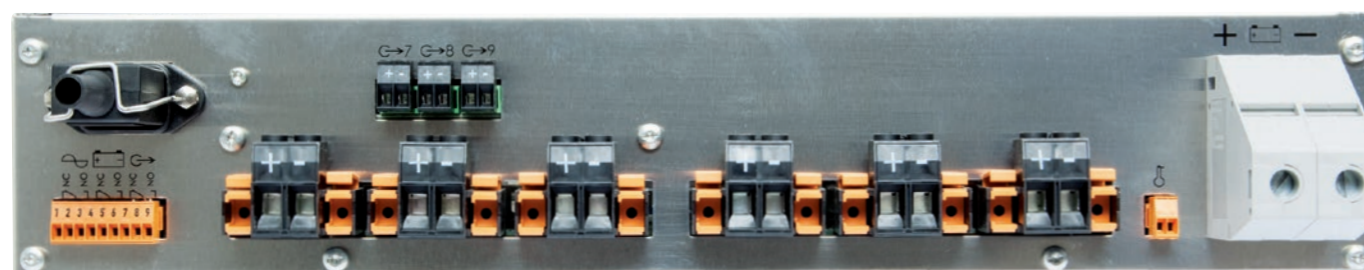

AES 24V/MS 150 rear panel

EN 54 16

VULCA VOICE range

COMPACT ALL-IN-ONE VOICE ALARM SYSTEM

EN 54 4



- Compact all-in-one Voice Alarm System certified EN 54-16 and EN 54-4
- 1 Alarm Zone
- Integrated amplifiers : up to 400W
- Amplifier and loudspeaker line monitoring
- Up to 4 broadcasting zones
- Integrated emergency microphone
- Integrated power supply (PSE)
- Ready for installation
- Easy to use
- Digital player
- Messages scheduler
- Specifically designed for small and medium installations

EN 54 16

VULCA VOICE range

CSC1-310-NF • CSC1-420-NF • CSC1-430-NF • CSC1-440-NF

EN 54 4

FEATURES

- The Vulca Voice range includes several different versions differentiated by the number of loudspeaker lines, the maximum power available per loudspeaker line and the total power available.
- Connected to a CIE (Control and Indicating Equipment), this system constitutes a single alarm zone. This alarm zone is divided into 1 to 4 loudspeaker lines.
- Memory support on SD card (or USB key) combined with the digital player makes it easy to personalize your messages and create different schedules.
- Set-up is simple, thanks to a small footprint (24 cm), full integration (amplifiers, power supply and back-up batteries) and suitable interfaces.
- Fireman Palm handheld microphone included.
- Digital matrix with priority management.
- Bells playlist included.
- Customizable playlist.
- 4 GPIs (logic inputs) - 4 GPOs (logic outputs).
- Integrated power supply (PSE) and batteries (batteries not included).
- gU wall enclosure.
- It's possible to use EN 54-24 compliant 100V loudspeakers subject to the addition of a capacitor (**ADAPTATEUR-VA**).
- Very easy to use, operation is carried out on the front panel HMI consisting of the LCD display, the 4 navigation keys as well as buttons and LEDs.

INSIDE

CSC1-310-NF		CSC1-420-NF		CSC1-430-NF		CSC1-440-NF	
300W	1	400W	2	400W	3	400W	4
Total power	Nb. of speaker lines	Total power	Nb. of speaker lines	Total power	Nb. of speaker lines	Total power	Nb. of speaker lines

- Vulca Voice is a range of compact, all-in-one Voice Alarm systems certified to European standards EN 54-16 and EN 54-4, meeting the requirements of the NF-SSI mark for France.
- They include an amplifier module, batteries (not included) and a battery charger in the same unit.
- These compact all-in-one systems are capable of managing 1 Alarm Zone, consisting of one to four speaker lines, depending on the model.
- Vulca Voice features a wall-mounted design. It is specially designed for small and medium-sized installations, with an alarm zone divided into 1 to 4 loudspeaker lines.
- Under voice alarm conditions, its role is to broadcast a pre-recorded evacuation message, or a spoken message in order to prompt the rapid and disciplined alert of the occupants of the emergency zone.

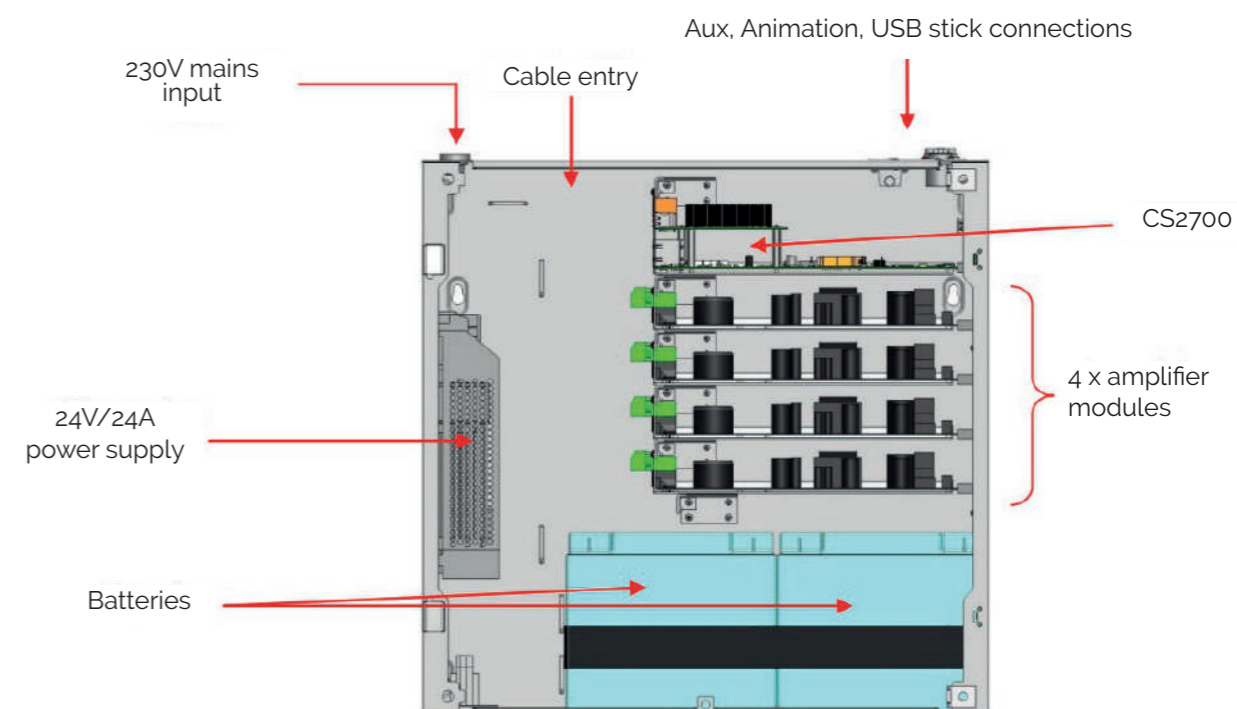

EN 54 16

VULCA VOICE range

EN 54 4

CSC1-310-NF · CSC1-420-NF · CSC1-430-NF · CSC1-440-NF

TECHNICAL CHARACTERISTICS

Model	CSC1-310-NF	CSC1-420-NF	CSC1-430-NF	CSC1-440-NF
Total power	300 W	400 W	400 W	400 W
Outputs / Nb. of speaker lines	1	2	3	4
Public Address console interface	Power supply : 24V DC – 550mA max @25°C			
Safety Console Interface	Power supply : 24V DC – 550mA max @25°C			
Interfaces	Ethernet IP / USB			
GPIs (General Purpose Inputs)	Number	4 (logic inputs)		
	Opto-isolated type	input current max. 10mA		
	Pulse duration	100ms minimum (in pulse mode)		
GPOs (General Purpose Outputs)	Number	4 (logic outputs)		
	Voltage/Current	24VDC/0.1A per GPO @25°C		
Frequency range	50 - 20 000 Hz			
Distortion	< 1%			
S/N ratio	> 70 dB			
Public Address inputs	4 (AUX, Animation, Telephone, Public Address Console input) + USB + SD card			
Aux Input	RCA connector x 2, stereo, sensitivity 0dbu, asymmetric signal			
Animation input	XLR-6.35 mm jack combo connector, mono, sensitivity 0dbu/-30dbu			
Telephone input	2-pin plug-in connector, mono, level 0dbu			
USB input	Yes			
Sensitivity	-30 dBm / 0 dBm			
Connectors	RCA x 2 / XLR - Jack combined connector / 2 pt terminal block / RJ 45 (Public Address Console Bus)			
PSE (Power Supply Equipment)	Fault information : dry contact, max. input current 10mA			
CIE (Control and Indicating Equipment)	Voltage triggering : from +15V to +58 V DC			
Emergency microphone	Type	dynamic, one direction (noise cancelling)		
	Sensitivity	-68dB/μbar (-48dB/Pascal)		
	Impedance	600 Ω		
Primary power source	Mains voltage	from 195V to 264V		
	Mains frequency	from 47 to 63Hz		
	Primary current	4A @ 195V		
Secondary power source	2 accumulator batteries , sealed, lead acid, 12V, with capacity between 17Ah and 42Ah			
Dimensions (H x L x P)	520 x 530 x 240 mm			
Material	Metal			
Operating temperature	-5°C to +40 °C			
Enclosure IP rating	IP 30			
Color	Industrial grey – RAL 7035			
Weight	Without batteries : 20,5 kg With batteries : 38,5 kg (batteries are not included)			
Evacuation message	Duration	22s		
	Content	NFS32001 siren + message "Votre attention s'il vous plait, nous vous demandons de quitter les lieux par les sorties les plus proches. Votre attention s'il vous plait, nous vous demandons de quitter les lieux par les sorties les plus proches. Le signal d'évacuation va retentir. Attention, attention, because of a technical hitch in our building, we ask you to evacuate the premises. Please go to the emergency exit"		

IMC 300T/VA

2-way Omnidirectional speaker - 30W

Patented omnidirectionality

Created by MAJORCOM and protected by an international patent, this powerful omnidirectional speaker is specifically adapted to the sound systems of large and very large volumes with loud noise levels: shopping centres, sports halls, ice rinks, swimming pools, airports, etc. Equipped with a heavy-duty, 16cm 2-way speaker and 30W a high-performance 100V line transformer, the IMC 300T/VA has a near Hi-Fi quality.

AUDIO QUALITY

It broadcasts quality sound without any frills.

SOUND COVERAGE

The patented reflector has earned the reputation of being the most efficient solution for achieving a large and homogeneous coverage zone (3 to 5 times larger than traditional enclosures, sound projectors, etc.).

OPTIMAL INTELLIGIBILITY

RASTI measurements have shown that our products respond in all cases to the intelligibility requirements of safety standard EN-5424 (Type A).

- 3 steel mounting slings (80cm) make it possible to suspend it securely.
- Optional specific RAL painting available : **PEINT OMNI** (minimum 6 pcs).

Model	IMC 300T/VA
Body & grill	Metal
Nominal power	30W
Nominal Impedance	330Ω
Power 100V Line	30/20/10W
Impedance	330 / 500 / 1.000Ω
Bandwidth	60Hz - 20kHz
Sensitivity (1W/1m)	84dB
SPL MAX 1m	98.8dB
Directivity (H-V) @ 500Hz	360° - 360°
Directivity (H-V) @ 1kHz	360° - 360°
Directivity (H-V) @ 2kHz	200° - 200°
Directivity (H-V) @ 4kHz	275° - 275°
Speaker	6.5" - 2 ways
Cone	Protected paper
Dimensions [mm]	Ø480/Ø370 x (H)260
Weight	4.5kg
Operating temperature	-15 to +55°C
Protection Index	IP54
Color	White

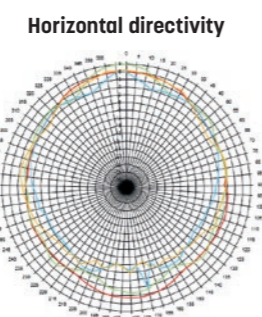
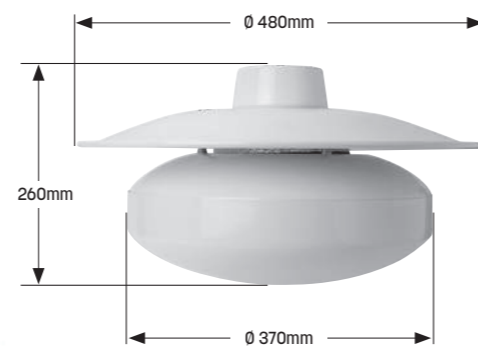

500Hz
1kHz
2kHz
4kHz

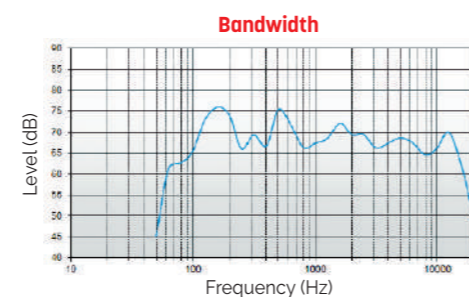
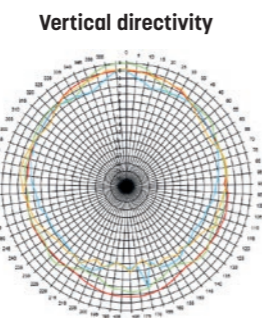

 n° 1134 20 Certificate n°: 1134-CPR-234 MAJORCOM 56 chemin de la Flambrère 31300 TOULOUSE FRANCE	EN 54-24 Speaker for voice alarm systems for systems for fire detection systems and fire alarm systems in buildings IMC 300T/VA Type A
---	---



B 420TW VA - B 420TB VA

20W Design Pendant Speakers

- The 20W pendant speaker is equipped with a 100mm 2-way bass reflex system and offers powerful sound with a wide and homogeneous dispersion.
- The B 420T VA has a 100V transformer with 4 power adjustments, these can be easily adjusted by a rotary switch on the top of the sphere. Low impedance operation is also possible.
- The impact-resistant, UV-resistant ABS plastic housing guarantees lasting stability.
- Additional operational safety is provided by the 2x2-pole ceramic terminal block, a thermal fuse, a PG screw connection integrated into the canopy and the moisture impregnation of the loudspeaker.
- The loudspeaker is protected against the risks of environmental influences with protection class IP65.

Model	B 420TW VA - B 420TB VA
Body & grill	ABS, Aluminium
Nominal power	20W
Nominal Impedance	500Ω
Power 100V Line	20 / 10 / 5 / 2,5W
Impedance	500 / 1.000 / 2.000 / 4.000Ω
Bandwidth	70 - 22.000Hz
Sensitivity (1W/1m)	83.9dB
SPL MAX 1m	96.9dB
Directivity (H-V) @ 500Hz	360°
Directivity (H-V) @ 1kHz	160°
Directivity (H-V) @ 2kHz	102°
Directivity (H-V) @ 4kHz	86°
Speaker	4"
Cone	PP polypropylene
Dimensions	Ø 189,4 x H 231mm
Weight	2.02kg
Operating temperature	-10 to +55°C
Protection Index	IP65
Color	B 420TW VA : White / B 420TB VA : Black

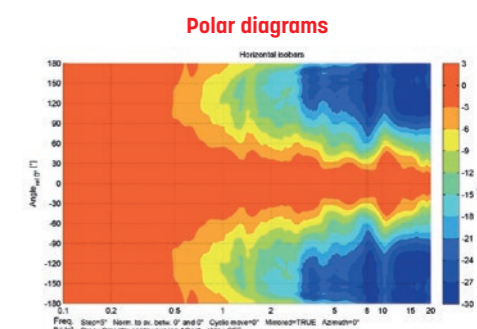
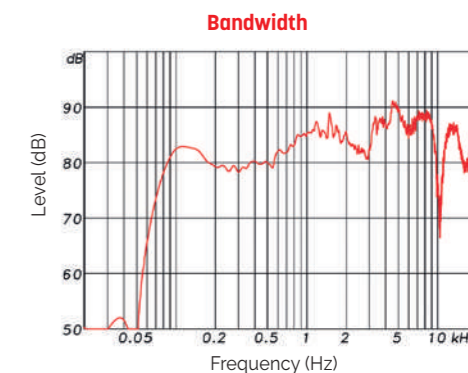

 n° 1438 22 Certificate n°: 1438-CPR-0872 MAJORCOM 56 chemin de la Flambrère 31300 TOULOUSE FRANCE	EN 54-24 Speaker for voice alarm systems for systems for fire detection systems and fire alarm systems in buildings B 420TW VA B 420TB VA Type A
--	---



PEND-3025B-EN 30W Pendant speaker

- Very good sound coverage : broadcast angle > 150°
- Dynamic sound : 5" full range driver
- Discrete and smooth design : aerodynamic shape, black matt
- Easy and quick installation : cable with carabiners, Euroblock terminal & potentiometer.
- This black pendant loudspeaker is composed of a 5" full range driver which guarantees a very good intelligibility of both your safety messages and your background music.
- It is ideal for spaces with high ceiling.
- Its installation remains easy with its Euroblock connector and its strong cable supplied with carabiners.



 n°1438 21 Certificat n° : 1438-CPR-0772 BOUYER 1270, avenue de Toulouse 82000 MONTAUBAN FRANCE	EN 54-24 Speaker for voice alarm systems for systems for fire detection systems and fire alarm systems in buildings
	PEND-3025B-EN Type A

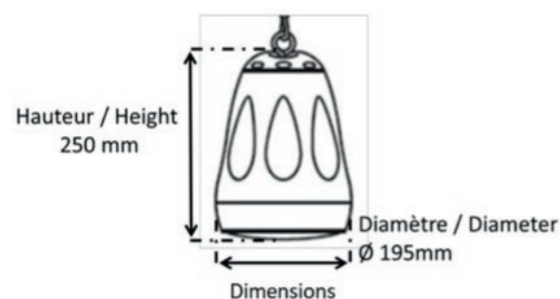

Model	PEND-3025B-EN
Nominal power	30 W
Impedance	30 W : 333 Ω / 15 W : 666 Ω / 7,5 W : 1333 Ω / 3,8 W : 2630 Ω
Power 100V Line	30 / 15 / 7,5 / 3,8 W + 8 Ω (adjustable with potentiometer)
Bandwidth	110 Hz - 20 kHz
Sensitivity (1W/1m)	85 dB
SPL MAX 1m	98 dB
Speaker	5" full range driver
Directivity (H-V) @ 500 Hz	360°
Directivity (H-V) @ 1 kHz	146,5°
Directivity (H-V) @ 2 kHz	82,5°
Directivity (H-V) @ 4 kHz	76,5°
Dimensions	Ø 195 x H 250 mm
Weight	2,2 kg
Operating temperature	-10°C à +55°C
Material	ABS
Protection Index	IP21 (resistant to humidity)
Color	Black
Accessories	Fixation cable + carabiners

CU 320T VA 20W Sound Column

- The 20W powered speaker is equipped with four 77mm full-range loudspeaker chassis and a 100V transformer with 4 power adjustments.
- The powder coated and shock-resistant aluminium housing in RAL 9006 guarantees long-term stability.
- For additional reliability, a 2 pin-ceramic block, a thermal fuse is provided and the speaker chassis is impregnated against wetness.
- Furthermore sturdy cable glands 2 x PG9 are also provided.
- The speaker is also secured with the high protection class IP66 against the security risks of environmental influences.
- Optional specific RAL painting available : **PEINT CU** (minimum 25 pcs).

Model	CU 320T VA
Body & grill	Aluminium
Nominal power	20W
Nominal Impedance	500Ω
Power 100V Line	20 / 15 / 10 / 5W
Impedance	500 / 667 / 1,000 / 2,000Ω
Bandwidth	147 - 23,500Hz
Sensitivity (1W/1m)	92,5dB
SPL MAX 1m	100,3dB
Directivity (H-V) @ 500Hz	360° - 124°
Directivity (H-V) @ 1kHz	188° - 65°
Directivity (H-V) @ 2kHz	149° - 38°
Directivity (H-V) @ 4kHz	86° - 14°
Speaker	4 x 3"
Dimensions (WxHxD)	510 x 100 x 92 mm
Weight	2,9kg
Operating temperature	-25°C - +70°C
Protection Index	IP66 - IK08
Color	RAL 9006

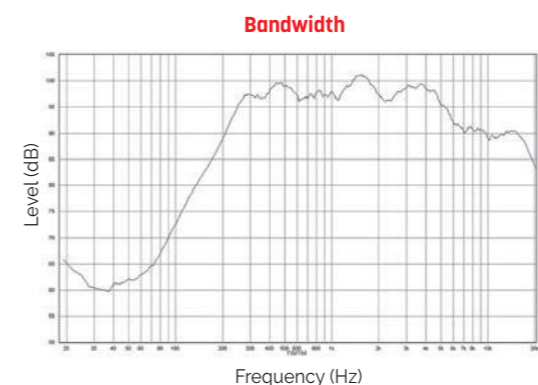

Polar diagrams

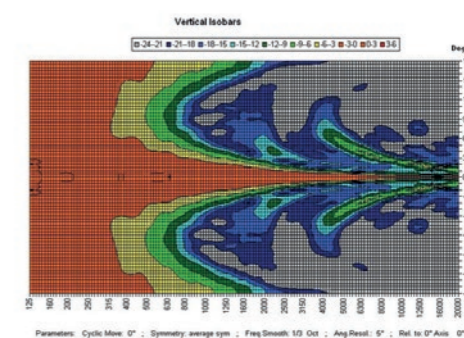
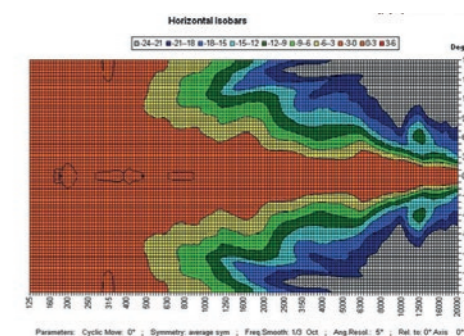

 n°1438 22 Certificat n° : 1438-CPR-0867 MAJORCOM: 56 chemin de la Flambrère 31300 TOULOUSE FRANCE	EN 54-24 Speaker for voice alarm systems for systems for fire detection systems and fire alarm systems in buildings
	CU 320T VA Type B

CU 350T VA 50W Sound Column

- The 50W powered speaker is equipped with four 77mm full-range loudspeaker chassis and a 100V transformer with 4 power adjustments.
- The powder coated and shock-resistant aluminium housing in RAL 9006 guarantees long-term stability.
- For additional reliability, a 2 pin-ceramic block, a thermal fuse is provided and the speaker chassis is impregnated against wetness.
- Furthermore sturdy cable glands 2 x PG9 are also provided.
- The speaker is also secured with the high protection class IP66 against the security risks of environmental influences.
- Optional specific RAL painting available : **PEINT CU** (minimum 25 pcs).



Model	CU 350T VA
Body & grill	Aluminium
Nominal power	50W
Nominal Impedance	200Ω
Power 100V Line	50 / 30 / 15 / 7.5W
Impedance	200 / 333 / 667 / 1,333Ω
Bandwidth	110 - 18,000Hz
Sensitivity (1W/1m)	94,7dB
SPL MAX 1m	111,7dB
Directivity (H-V) @ 500Hz	360° - 73°
Directivity (H-V) @ 1kHz	186° - 33°
Directivity (H-V) @ 2kHz	173° - 17°
Directivity (H-V) @ 4kHz	98° - 6°
Speaker	8 x 3"
Dimensions (WxHxD)	100 x 971 x 92mm
Weight	5,2kg
Operating temperature	-25°C ~+70°C
Protection Index	IP66 - IK08
Color	RAL 9006

Polar diagrams

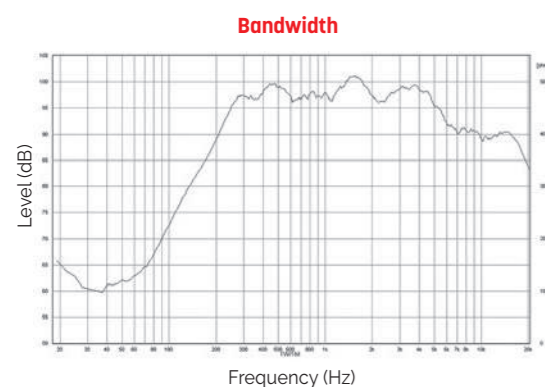
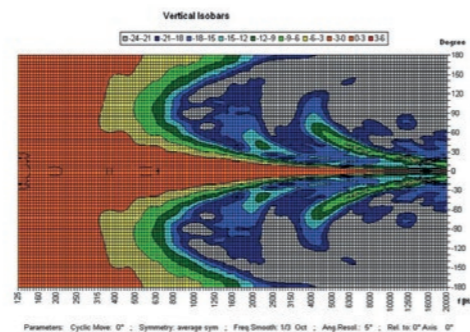
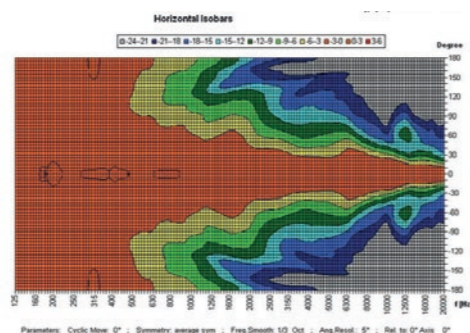

 n°1438 22 Certificat n°: 1438-CPR-0867 MAJORCOM: 56 chemin de la Flambrère 31300 TOULOUSE FRANCE	EN 54-24 Speaker for voice alarm systems for systems for fire detection systems and fire alarm systems in buildings CU 350T VA Type B

MS 530TB VA - MS 530TW VA 2-Way Wall Speakers - 30W

- The MS Serie compact wall speakers impress by a sophisticated design and by its powerful sound.
- Perfectly suitable for installations where high sound quality is needed..
- The 30W powered speaker is equipped with a high quality 2-way system and a 100V transformer with 3 power adjustments.
- The impact-resistant, UV-resistant ABS plastic housing assures enduring stability.
- For additional reliability, a thermal fuse and a wetness impregnation of the speaker is provided.
- The speaker is also secured with protection class IP65 against the risks of environmental influences.



MS 530TB VA (Black)



MS 530TW VA (White)

Model	MS 530TB VA - MS 530TW VA
Body & grill	ABS
Nominal power	30W
Nominal Impedance	333Ω
Power 100V Line	30 / 15 / 7,5 / 3,75W
Impedance	333 / 667 / 1,333 / 4,000Ω
Bandwidth	50 - 23,500Hz
Sensitivity (1W/1m)	85dB
SPL MAX 1m	105,6dB
Directivity (H-V) @ 500Hz	360° - 360°
Directivity (H-V) @ 1kHz	200° - 160°
Directivity (H-V) @ 2kHz	130° - 100°
Directivity (H-V) @ 4kHz	120° - 40°
Speaker	5"
Dimensions (WxHxD)	160 x 262 x 153 mm
Weight	2,5kg
Operating temperature	-25°C ~+70°C
Protection Index	IP65 - IK09
Color	MS 530TB VA: Black / MS 530TW VA: White

Polar diagrams

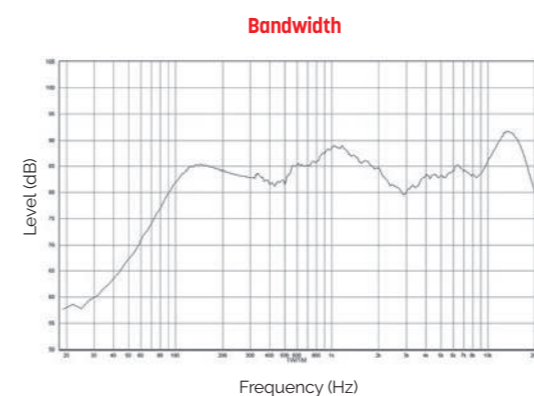
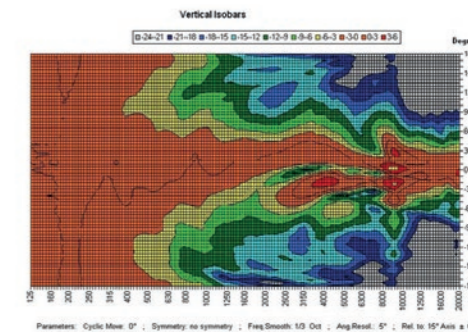
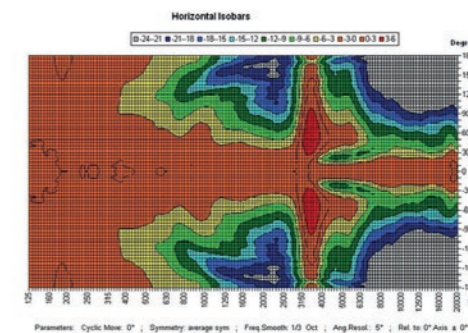

 n°1438 22 Certificat n°: 1438-CPR-0870 MAJORCOM: 56 chemin de la Flambrère 31300 TOULOUSE FRANCE	EN 54-24 Speaker for voice alarm systems for systems for fire detection systems and fire alarm systems in buildings MS 530TB VA MS 530TW VA Type B

MS 650TB VA - MS 650TW VA 2-Way Wall Speakers - 50W

- The MS Serie compact wall speakers impress by a sophisticated design and by its powerful sound.
- Perfectly suitable for installations where high sound quality is needed..
- The 30W powered speaker is equipped with a high quality 2-way system and a 100V transformer with 3 power adjustments.
- The impact-resistant, UV-resistant ABS plastic housing assures enduring stability.
- For additional reliability, a thermal fuse and a wetness impregnation of the speaker is provided.
- The speaker is also secured with protection class IP65 against the risks of environmental influences.



MS 650TB VA (Black)

MS 650TW VA (White)

Model	MS 650TB VA - MS 650TW VA
Body & grill	ABS
Nominal power	50W
Nominal Impedance	200Ω
Power 100V Line	50 / 25 / 12,5 / 6,25W
Impedance	200 / 400 / 800 / 1,600Ω
Bandwidth	52 - 25,000Hz
Sensitivity (1W/1m)	88,8dB
SPL MAX 1m	105,1dB
Directivity (H-V) @ 500Hz	360° x 360°
Directivity (H-V) @ 1kHz	200° x 155°
Directivity (H-V) @ 2kHz	110° x 120°
Directivity (H-V) @ 4kHz	80° x 25°
Speaker	6"
Dimensions (WxHxD)	205 x 330 x 192 mm
Weight	3,65kg
Operating temperature	-25°C ~+70°C
Protection Index	IP65 - IK09
Color	MS 650TB VA: Black / MS 650TW VA: White

Polar diagrams

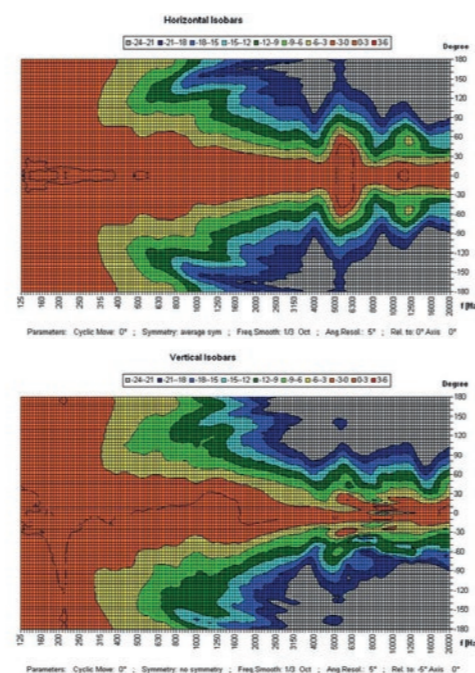

 n°1438 22 Certificat n°: 1438-CPR-0870 MAJORCOM: 56 chemin de la Flambrère 31300 TOULOUSE FRANCE	EN 54-24 Speaker for voice alarm systems for systems for fire detection systems and fire alarm systems in buildings
	MS 650TB VA MS 650TW VA Type B

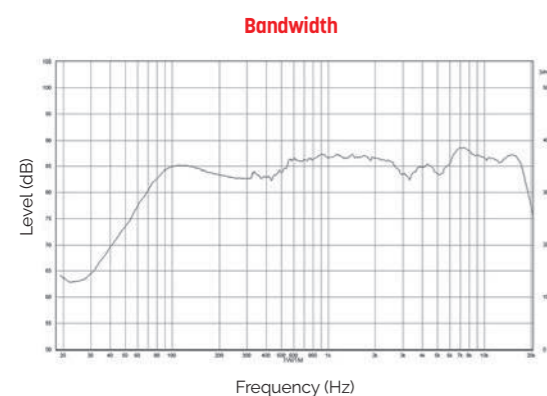

CB 56T VA 6W Wall mounted Speaker

- The 6W powered speaker is equipped with a 165mm full-range loudspeaker and a 100V transformer with 3 power adjustments 6/3/1.5W.
- The high-density, shock-resistant MDF wood housing in white provides a low resonance sound. A sturdy front grille made of steel guarantees enduring stability.
- For additional reliability, a 2 pin-ceramic block, a thermal fuse is provided and the speaker chassis is impregnated against wetness.
- The speaker is also secured with the high protection class IP54 against the security risks of environmental influences.
- The proven spring clamp on the rear plate ensures a quick mounting on walls.

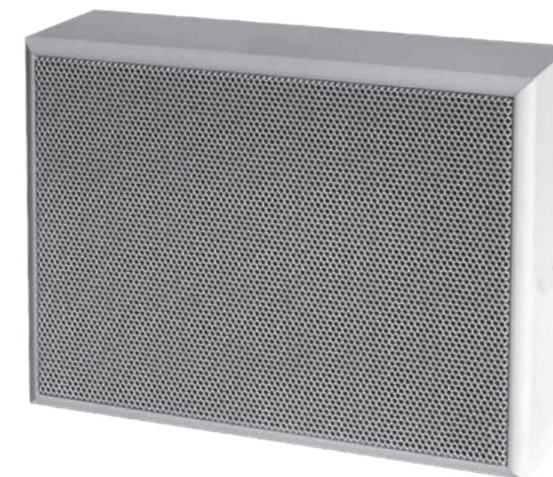

Model	CB 56T VA
Body & grill	MDF, Steel
Nominal power	6W
Nominal Impedance	1667Ω
Power 100V Line	6 / 3 / 1,5W
Impedance	1667 / 3,333 / 6,667Ω
Bandwidth	197 - 21,900Hz
Sensitivity (1W/1m)	93dB
SPL MAX 1m	100,8dB
Directivity (H-V) @ 500Hz	180°
Directivity (H-V) @ 1kHz	160°
Directivity (H-V) @ 2kHz	125°
Directivity (H-V) @ 4kHz	89°
Speaker	5"
Cone	Paper
Dimensions (WxHxD)	254 x 195 x 81mm
Weight	1,95kg
Operating temperature	-10 to +55°C
Protection Index	IP54
Color	White

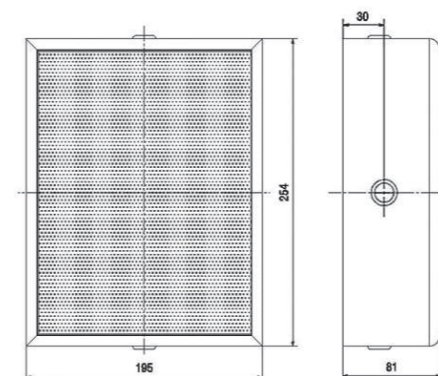

Bandwidth

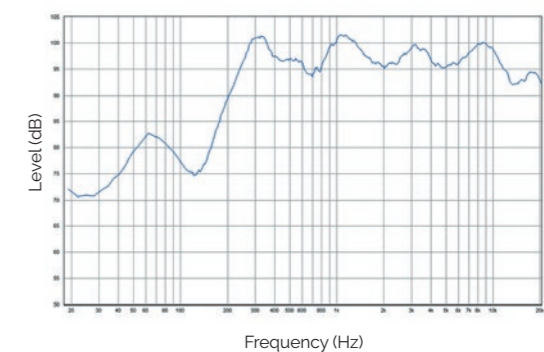

Polar diagrams

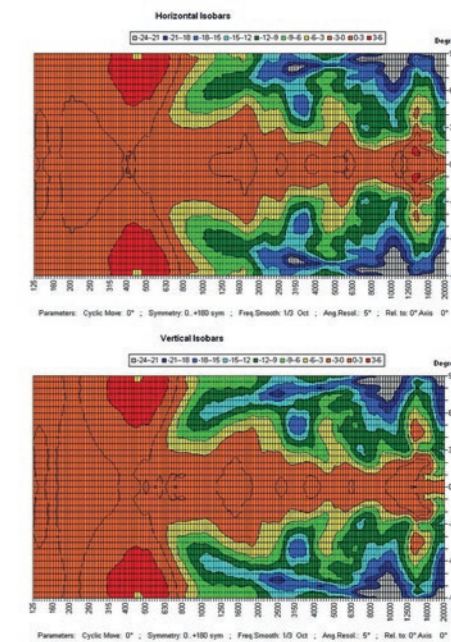

 n°1438 22 Certificate n°: 1438-CPR-0868 MAJORCOM: 56 chemin de la Flambrère 31300 TOULOUSE FRANCE	EN 54-24 Speaker for voice alarm systems for systems for fire detection systems and fire alarm systems in buildings
	CB 56T VA Type A

CSE 56T VA 6W Ceiling Speaker

- The 6W powered speaker is equipped with a 130mm full-range loudspeaker and a 100V transformer with 3 power adjustments 6W, 3W and 1.5W.
- Thanks to an innovative air flow system, the CSE 56T VA provides sound characteristics which are attributed to a conventional bass speaker.
- An extremely flat construction method allows a low mounting depth of only 70mm, with less than 1kg product weight.
- For additional reliability the speaker is impregnated against wetness.
- Quick and easy mounting with spring clamps and short tension distance. Perfectly suitable for installations where the installation depth is very limited. This speaker is suitable for a ceiling strength of about 3 - 45mm.
- Optional specific RAL painting available : **PEINT PLAFONNIER** (minimum 25 pcs).
- Optional metallic fire dome available: **FD CSE 56T VA**



Model	CSE 56T VA
Body & grill	Metal, plastic PET contact protection
Nominal power	6W
Nominal Impedance	666Ω
Power 100V Line	6 / 3 / 1.5W
Impedance	1.667 / 3.333 / 6.667Ω
Bandwidth	104 - 17 200Hz
Sensitivity (1W/1m)	86,8dB
SPL MAX 1m	98,3dB
Directivity (H-V) @ 500Hz	180°
Directivity (H-V) @ 1kHz	180°
Directivity (H-V) @ 2kHz	140°
Directivity (H-V) @ 4kHz	85°
Speaker	5"
Cone	Coated paper
Dimensions	Ø 181,5 x D 65mm (181,5 x 91,5mm fire dome)
Ceiling Cut-out	Ø 156mm
Weight	0,51kg (0,71kg with fire dome)
Operating temperature	-10°C / +55°C
Protection Index	IP21C
Color	RAL 9016

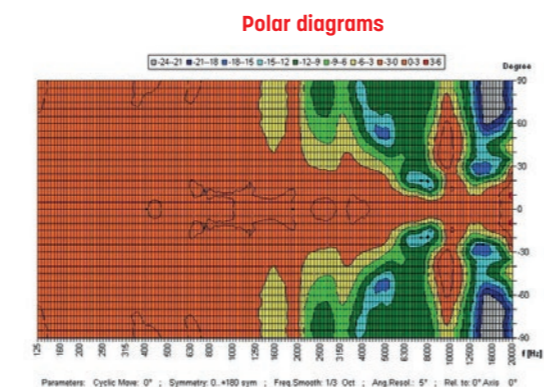
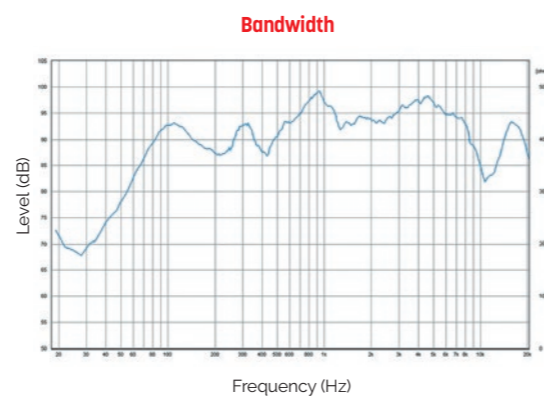

FD CSE 56T VA

 n°1438 22 Certificate n°: 1438-CPR-0866 MAJORCOM: 56 chemin de la Flamrière 31300 TOULOUSE FRANCE	EN 54-24 Speaker for voice alarm systems for systems for fire detection systems and fire alarm systems in buildings
	CSE 56T VA Type A

P 515T VA 2-Way Ceiling Speaker - 15W

- P 515T VA is a 2 way bass reflex ceiling speaker suitable for high quality installation.
- Fitted with a 5" speaker, a neodymium tweeter and a 100V transformer with 4 power taps, it offers a very high sound quality.
- Easy installation via screw mounting system.
- Optional specific RAL painting available : **PEINT PLAFONNIER** (minimum 25 pcs).

Model	P 515T VA
Body & grill	ABS
Nominal power	15W
Nominal Impedance	667Ω
Power 100V Line	15 / 7,5 / 3,75 / 1,9W
Impedance	667 / 1.333 / 2.667 / 5.263Ω
Bandwidth	100 - 22.800Hz
Sensitivity (1W/1m)	86,2dB
SPL MAX 1m	98dB
Directivity (H-V) @ 500Hz	180°
Directivity (H-V) @ 1kHz	180°
Directivity (H-V) @ 2kHz	145°
Directivity (H-V) @ 4kHz	95°
Speaker	5"
Dimensions (mm)	Ø 213 x P 152
Ceiling Cut-out	Ø 178mm
Weight	1,73kg
Operating temperature	-10°C ~ +55°C
Protection Index	IP21C
Color	RAL 9016

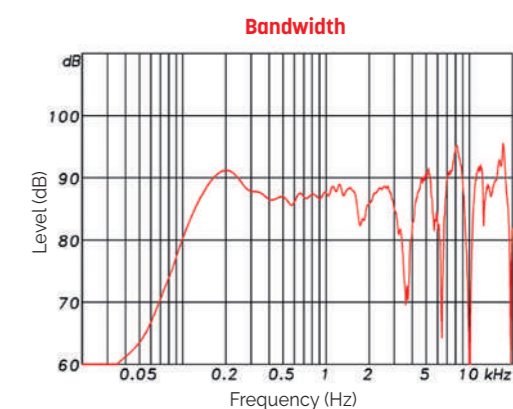

Polar diagrams

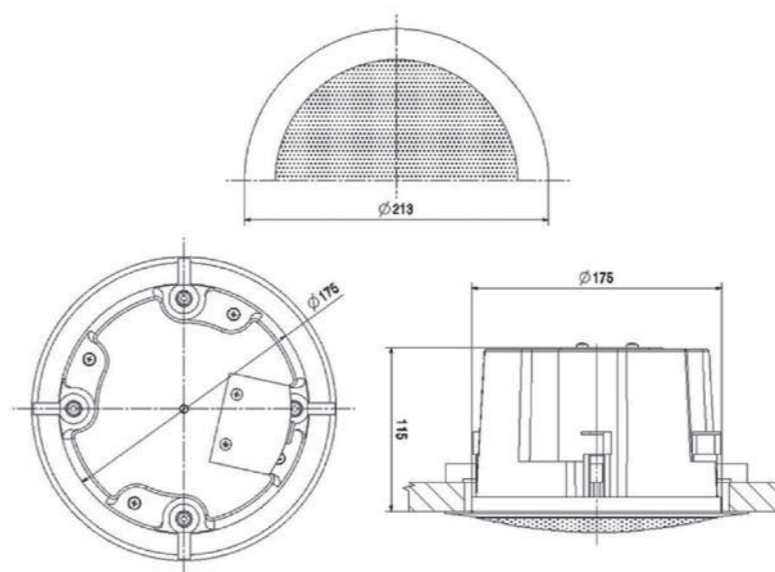
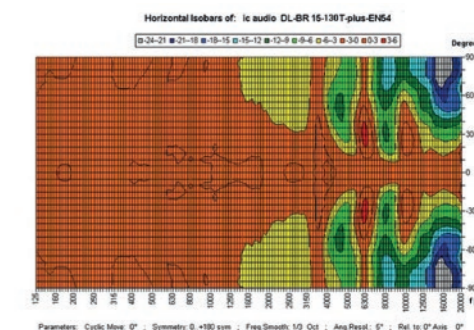

 n°1438 22 Certificate n°: 1438-CPR-0856 MAJORCOM: 56 chemin de la Flamrière 31300 TOULOUSE FRANCE	EN 54-24 Speaker for voice alarm systems for systems for fire detection systems and fire alarm systems in buildings
	P 515T VA Type A

P 630T VA

2-Way Ceiling Speaker - 30W

- P 630T VA is a 2 way bass reflex ceiling speaker suitable for high quality installation.
- Fitted with a 6.5" speaker, a neodymium tweeter and a 100V transformer with 4 power taps, it offer a very high sound quality.
- Easy installation via screw mounting system.
- Optional specific RAL painting available : **PEINT PLAFONNIER** (minimum 14 pcs).

Model	P 630T VA
Body & grill	ABS
Nominal power	30W
Nominal Impedance	333Ω
Power 100V Line	30 / 15 / 7,5 / 3,75W
Impedance	333 / 667 / 1,333 / 2,667Ω
Bandwidth	87 - 19 300Hz
Sensitivity (1W/1m)	89,8dB
SPL MAX 1m	110,2dB
Directivity (H-V) @ 500Hz	180°
Directivity (H-V) @ 1kHz	180°
Directivity (H-V) @ 2kHz	115°
Directivity (H-V) @ 4kHz	62°
Speaker	6.5"
Dimensions (mm)	∅ 239,5 x D 176,5
Ceiling Cut-out	∅ 210mm
Weight	2,27kg
Operating temperature	-10°C ~+55°C
Protection Index	IP21C
Color	RAL 9016

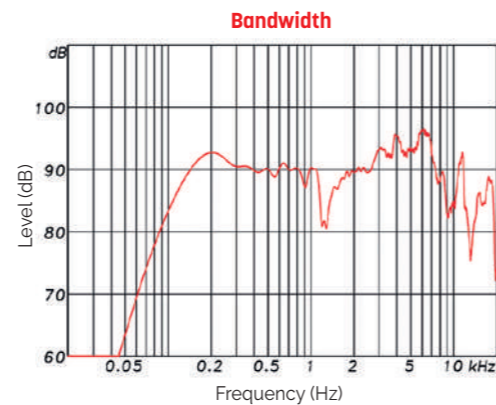

Polar diagrams

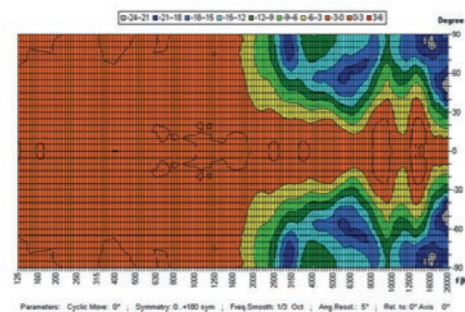

 n°1438 22 Certificate n°: 1438-CPR-0856 MAJORCOM: 56 chemin de la Flambrère 31300 TOULOUSE FRANCE	EN 54-24 Speaker for voice alarm systems for systems for fire detection systems and fire alarm systems in buildings
	P 630T VA Type A

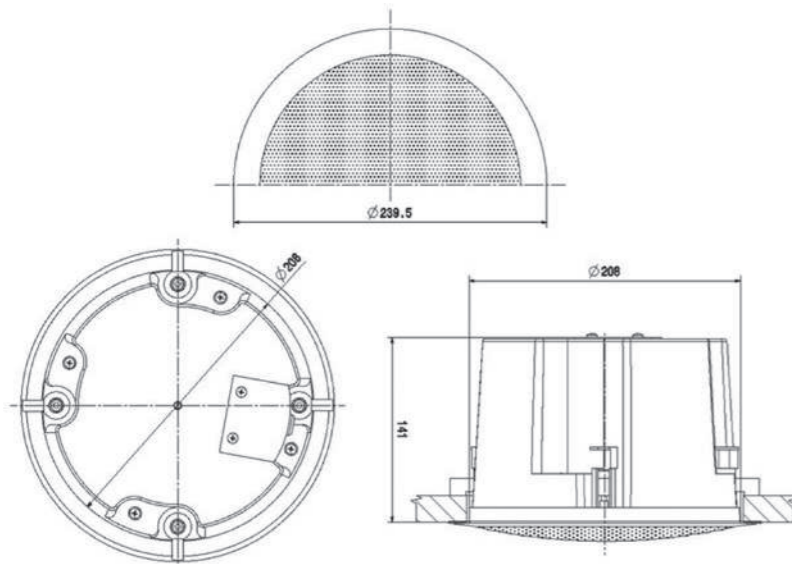

P 860T VA

2-Way Ceiling Speaker - 60W

- P 860T VA is a 2 way bass reflex ceiling speaker suitable for high quality installation.
- Fitted with a 8" speaker, a neodymium tweeter and a 100V transformer with 4 power taps, it offers a very high sound quality.
- Easy installation via screw mounting system.
- Optional specific RAL painting available : **PEINT PLAFONNIER** (minimum 14 pcs).

Model	P 860T VA
Body & grill	Metal
Nominal power	60W
Nominal Impedance	167Ω
Power 100V Line	60 / 30 / 15 / 7,5W
Impedance	167 / 333 / 667 / 1,333Ω
Bandwidth	50 - 24,000Hz
Sensitivity (1W/1m)	91,2dB
SPL MAX 1m	110,7dB
Directivity (H-V) @ 500Hz	180°
Directivity (H-V) @ 1kHz	165°
Directivity (H-V) @ 2kHz	130°
Directivity (H-V) @ 4kHz	80°
Speaker	8"
Dimensions (mm)	∅ 319 x D 254
Ceiling Cut-out	∅ 302mm
Weight	4,7kg
Operating temperature	-10°C ~+55°C
Protection Index	IP21C
Color	RAL 9016

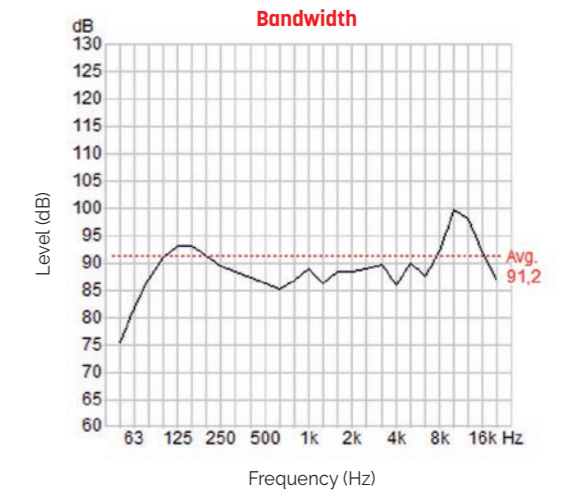

Polar diagrams

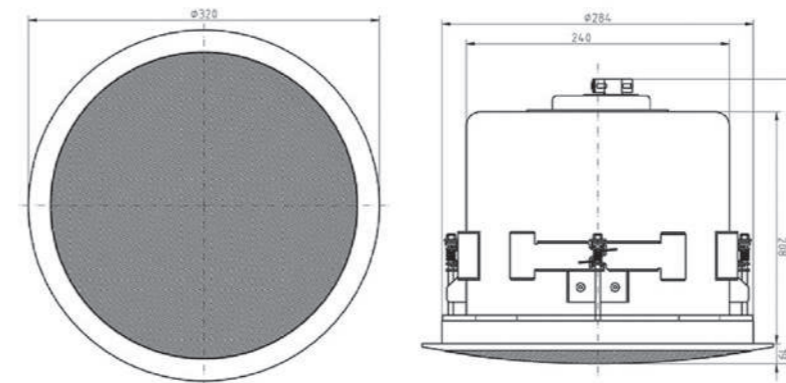
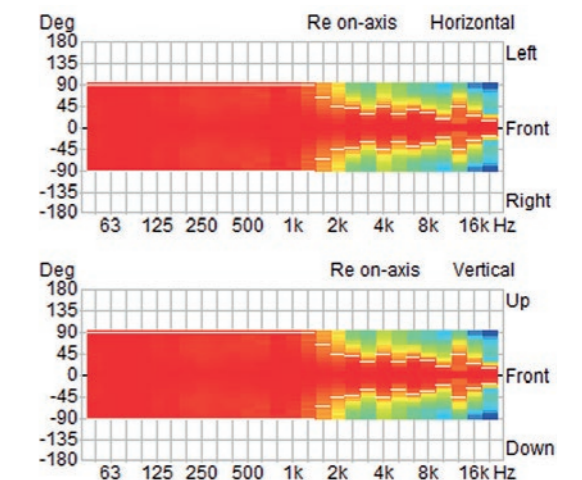

 n°1438 22 Certificate n°: 1438-CPR-0854 MAJORCOM: 56 chemin de la Flambrère 31300 TOULOUSE FRANCE	EN 54-24 Speaker for voice alarm systems for systems for fire detection systems and fire alarm systems in buildings
	P 860T VA Type A

PSUB 120T

120W Ceiling subwoofer

- This 120W powered subwoofer is equipped with a 200mm high-performance system featuring 4 power adjustments 120/60/30/15W.
- PSUB 120T offers an amazing deep bass response which gives your voice alarm installation a rich sound quality.
- Power tapings are easily set at the front of the speaker, a low impedance operation at 4ohm is also possible. The crossover frequency is set to 135Hz. You can change the phase 180° by a switch at the front. To make things perfect the metal housing in RAL 9016 guarantees long-term durability.
- Protection class IP21C secures the speaker against the risks of environmental influences. The speaker chassis is impregnated against wetness. Easy installation via screw mounting system.
- Perfectly suitable for installations where high sound quality is demanded.
- Optional specific RAL painting available : **PEINT PLAFONNIER** (minimum 14 pcs).



Model	PSUB 120T
Body & grill	ABS / Metal
Nominal power	120W
Nominal Impedance	83Ω
Power 100V Line	120 / 60 / 30 / 15W
Impedance	83 / 167 / 333 / 667Ω - 4Ω
Bandwidth	32 - 280Hz
Sensitivity (1W/1m)	87dB
SPL MAX 1m	107,8dB
Dimensions (mm)	Ø 319 x P 250
Ceiling Cut-out	Ø 302mm
Weight	6,4kg
Operating temperature	-10°C ~+55°C
Protection Index	IP21C
Color	RAL 9016

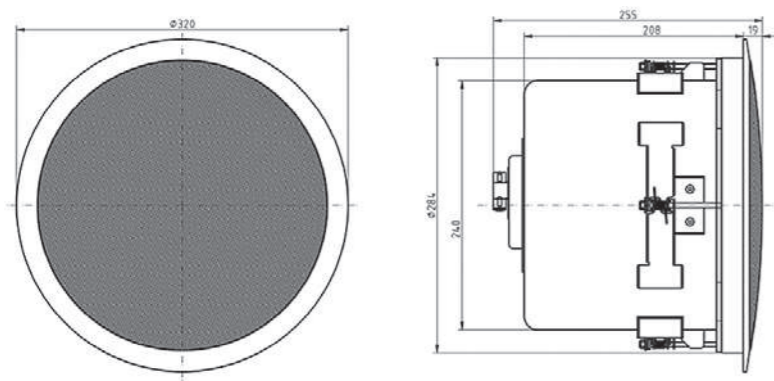
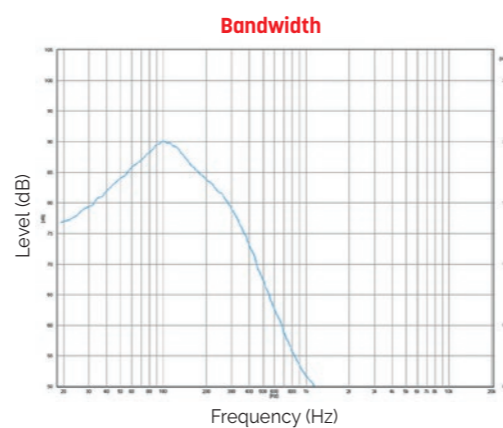

IMPI 330T VA

Indoor/outdoor sound projector - 10W

Compliant with the international standards relative to public address and evacuation installations (EN 54-24 Type B and ISO 7240-24), this sound projector is recommended for the equipment of all types of public places such as train stations, pedestrian streets, car parks etc.

QUALITY SPEECH AND MUSIC REPRODUCTION

Equipped with a 12cm diameter loudspeaker, its frequency response makes it possible to broadcast high-quality music and information messages.

EASY TO INSTALL

A solid aluminium bracket is provided to facilitate the installation and orientation of the projector in almost all positions. It is possible to mount the bracket first and then the sound projector.

WITHSTANDS ALL KINDS OF WEATHER

Made of extruded aluminium, it can be installed indoors or outdoors (IP55) and blends in with most surroundings.

- Optional specific RAL painting available : **PEINT PROJECTEUR** (minimum 15 pcs).

Model	IMPI 330T VA
Body & grill	Aluminium
Nominal power	10W
Nominal Impedance	1kΩ
Power 100V Line	10 / 5 / 2.5W
Impedance	1 / 2 / 4kΩ
Bandwidth	120Hz - 20kHz
Sensitivity (1W/1m)	95dB
SPL MAX 1m	103dB
Directivity (H-V) @ 500Hz	360° - 360°
Directivity (H-V) @ 1kHz	240° - 260°
Directivity (H-V) @ 2kHz	115° - 115°
Directivity (H-V) @ 4kHz	54° - 54°
Speaker	5"
Cone	Plastic
Dimensions [mm]	Ø138 x (D)225
Weight	2,5kg
Operating temperature	-25 to +70°C
Protection Index	IP55
Color	White



Horizontal directivity

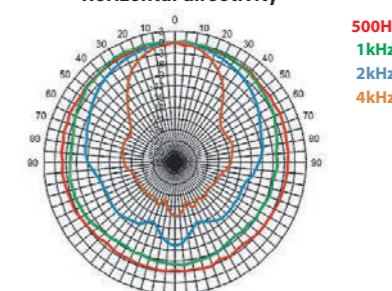

Vertical directivity

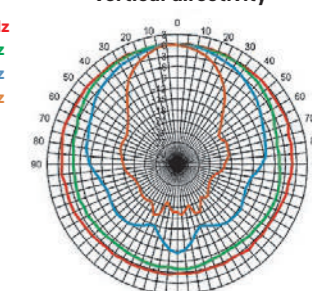

Bandwidth

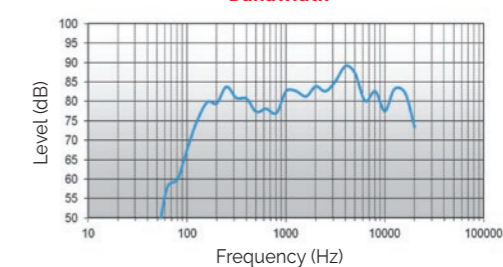

 n° ANPI 12 Certificate n° : 1134-CPR-116 MAJORCOM: 56 chemin de la Flamèche 31300 TOULOUSE FRANCE	EN 54-24 Speaker for voice alarm systems for systems for fire detection systems and fire alarm systems in buildings
	IMPI 330T VA Type B

IMPI 2510T VA**Bi-directional Sound Projector - 10W**

- The 10W powered speaker is equipped with two 130mm full-range loudspeakers and a 100V line transformer with 4 power adjustments.
- A robust powder coated aluminum housing in RAL 9010, and a vandal-resistant feet ensure a permanent installation of this speaker.
- For additional reliability, a 2x2 pin-ceramic block and a thermal fuse is provided and the speaker chassis is impregnated against wetness.
- Optional specific RAL painting available : **PEINT DUAL** (minimum 25 pcs).

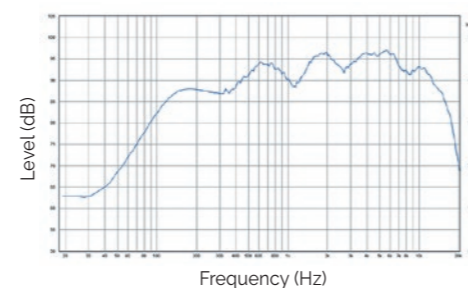
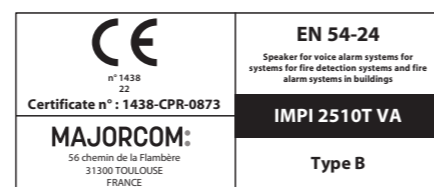
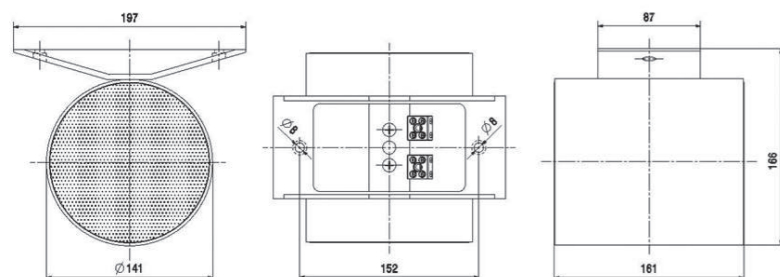
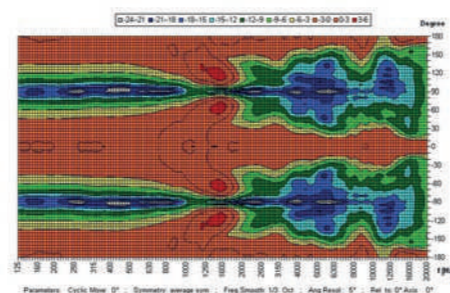

Model	IMPI 2510T VA
Body & grill	Aluminium
Nominal power	10W
Nominal Impedance	1000Ω
Power 100V Line	10 / 6 / 3 / 1,5W
Impedance	1,000 / 1,667 / 3,333 / 6,667Ω
Bandwidth	237 - 12 400Hz
Sensitivity (1W/1m)	89,6dB
SPL MAX 1m	95,3dB
Directivity (H-V) @ 500Hz	2 x 130°
Directivity (H-V) @ 1kHz	2 x 150°
Directivity (H-V) @ 2kHz	2 x 145°
Directivity (H-V) @ 4kHz	2 x 75°
Speaker	2 x 5"
Cone	Coated paper
Dimensions (WxDxH)	197 x 161 x 166mm
Weight	2,35kg
Operating temperature	-25 to +70°C
Protection Index	IP65
Color	RAL 9010

Bandwidth**Polar diagrams****SPJ-52WHBS****2-way bi-directional sound projector - 20W**

- Excellent reproduction of voice and music
- Built-in connector and connection cables
- For installation on the ceiling or on the wall
- Protection from water and dust, IP66
- The SPJ-52WHBS is a powerful, 20-W bidirectional sound projector designed for the high-quality reproduction of voice and music.
- It can be used inside or outside. The two opposing speakers are perfect for applications such as metro stations, train stations, parking garages, and make it possible to cut the number of speakers in half.
- The SPJ-52WHBS is equipped with a ceramic terminal block, a thermal fuse and wires that can withstand high temperatures.

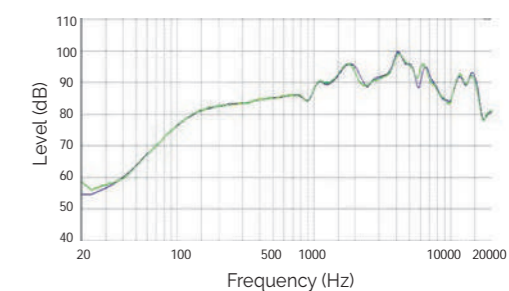
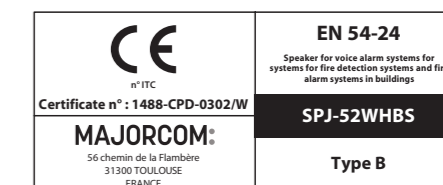
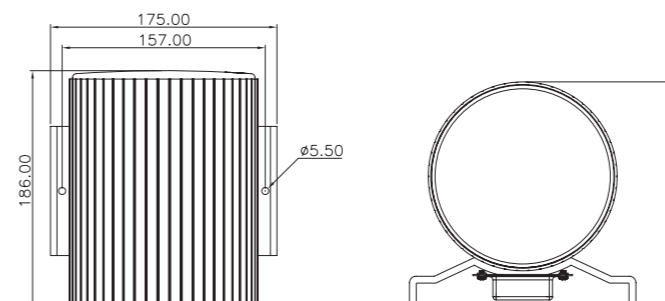
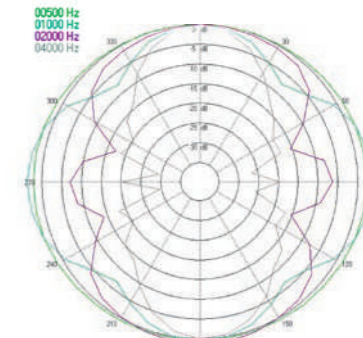

Model	SPJ-52WHBS
Body & grill	Aluminium
Nominal power	20W
Nominal Impedance	500Ω
Power 100V Line	20 / 10 / 5W
Impedance	500 / 1,000 / 2,000Ω
Bandwidth	120Hz - 20,000Hz
Sensitivity (1W/1m)	88dB
SPL MAX 1m	100dB
Directivity (H-V) @ 500Hz	360°
Directivity (H-V) @ 1kHz	320°
Directivity (H-V) @ 2kHz	200°
Directivity (H-V) @ 4kHz	80°
Speaker	2 x 5"
Cone	Paper composite
Dimensions	Ø 146 x 186mm
Weight	3,2kg
Operating temperature	-20 to +70°C
Protection Index	IP66

Bandwidth**Directivity**

SPOT2010-EN5424 20W Sound Projector

- High intelligibility
- Protection index IP 55
- Inconspicuous & multipurpose
- Easy and quick installation
- The SPOT2010-EN5424 is a 20W sound projector fitted with a dual cone loudspeaker.
- Its fixing device facilitates its orientation and ensures an easy and quick installation : wall- or ceiling mounting.
- Made out of ABS, it is weatherproof, shock and corrosion resistant. Therefore, it can be installed in any type of environment

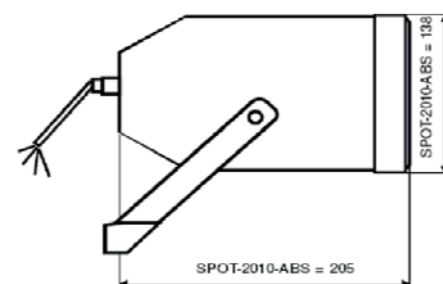
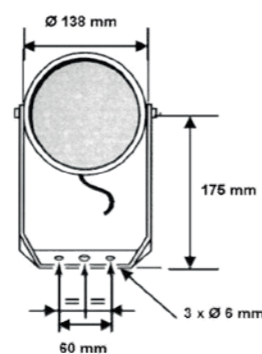
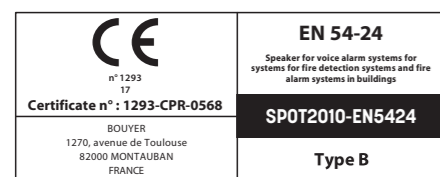

Model	SPOT2010-EN5424
Nominal power	20 W
Power 100V Line	20 / 10 / 5 W
Frequency range	110 - 17 000 Hz
Impedance	20 W : 0,5 kΩ / 10 W : 1 kΩ / 5 W : 1,8 kΩ
Sensitivity (1W/1m)	100 dB
SPL Max 1m	112 dB / 20W
Directivity (-6dB)	500 Hz : 180° 4 KHz : 75°
Speaker	Ø 12,5 cm dual cone
Dimensions	Ø 138 x 205 mm
Fixed centre distance	2 x 60 mm
Weight	1,6 kg
Material	ABS + Alu grid
Protection rating	IP55
Color	White
Connexion	Block terminals

IMPI 520T VA 20W Design Sound Projector

- The 20W design speaker with an amazing concave shape is equipped with a 130mm full-range speaker and a 100V transformer with 3 power adjustments 20/10/5W.
- Acoustically the design loudspeaker convinces at all levels. Thanks to a smart phase-shifting and a high-quality midrange resonator, the speaker offers a sound characteristic that is matching a 2-way system.
- In addition, the very wide dispersion ensures a comprehensive sound.
- A robust, ABS plastic housing in RAL9016 and a stable aluminium mounting bracket guarantee a durable installation.
- The cable is fed via a cable gland (PG11). The integrated 2x2-pole ceramic block and thermal fuse as well as the moisture impregnation of the loudspeaker ensure additional safety.



Model	IMPI 520T VA
Body & grill	ABS, Aluminium
Nominal power	20W
Nominal Impedance	500Ω
Power 100V Line	20 / 10 / 5W
Impedance	500 / 1,000 / 2,000Ω
Bandwidth	142 - 14,300Hz
Sensitivity (1W/1m)	88,4dB
SPL MAX 1m	100dB
Directivity (H-V) @ 500Hz	360°
Directivity (H-V) @ 1kHz	155° - 220°
Directivity (H-V) @ 2kHz	95° - 85°
Directivity (H-V) @ 4kHz	80° - 85°
Speaker	5"
Cone	PP polypropylene
Dimensions (WxDxH)	166,4 x 283,5 x 169mm
Weight	1,76kg
Operating temperature	-25 to +70°C
Protection Index	IP65
Color	RAL 9016

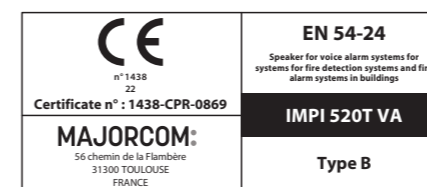
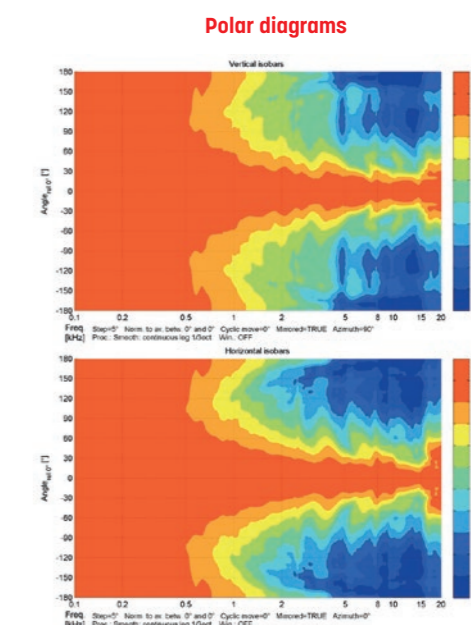
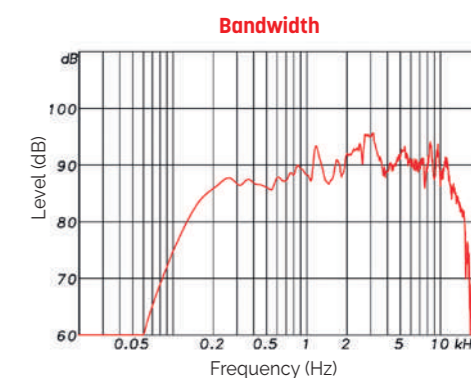
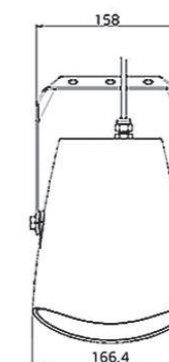
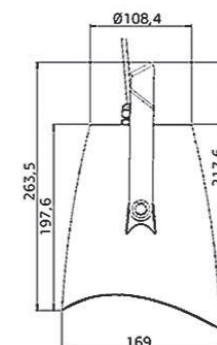

PHS-81T30BS 30W Horn Speaker

- High performance enclosure
 - High-quality vocal reproduction
 - Protection from water and dust, IP66
- The high-performance horn speaker faithfully reproduces speech with excellent sound distribution and can be used in a wide range of outdoor applications. The perfect solution for sports fields, parks, factories and outdoor pools
 - The speaker is equipped with a ceramic terminal block, a thermal fuse and wires that can withstand high temperatures.
 - Included is a U-shaped, stainless steel universal mount and screws (both AISI 316) for flexible installation.



Model	PHS-81T30BS
Body & grill	ABS fireproof
Nominal power	30W
Nominal Impedance	333Ω
Power 100V Line	30 / 15 / 7.5 / 3.75W
Impedance	333 / 666 / 1,333 / 2,667Ω
Bandwidth	340Hz - 9kHz
Sensitivity (1W/1m)	108dB
SPL MAX 1m	123dB
Directivity (H-V) @ 500Hz	200°
Directivity (H-V) @ 1kHz	120°
Directivity (H-V) @ 2kHz	60°
Directivity (H-V) @ 4kHz	30°
Dimensions [mm]	∅212 x 280
Weight	2,05kg
Operating temperature	-25 to +70°C
Protection Index	IP66
Color	White

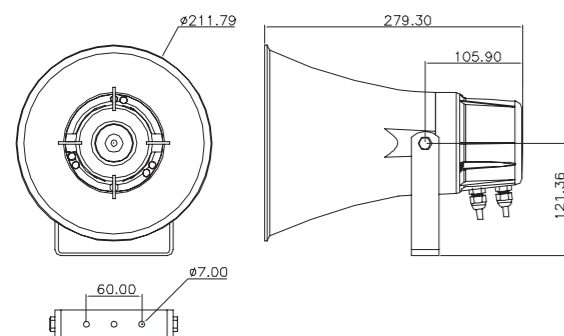
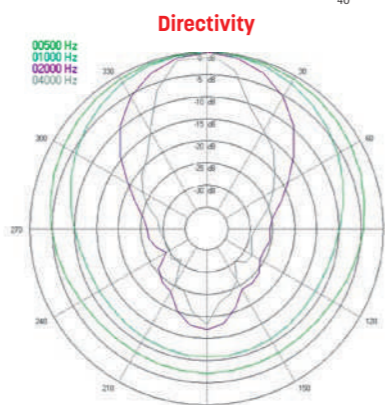
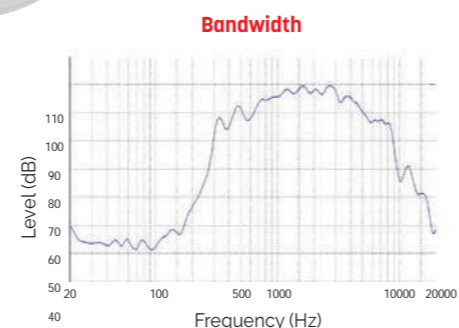

 n° 1438 Certificate n° : 1488-CPD-0314/W MAJORCOM: 56 chemin de la Flambrère 31300 TOULOUSE FRANCE	EN 54-24 Speaker for voice alarm systems for systems for fire detection systems and fire alarm systems in buildings
	PHS-81T30BS
	Type B

TU 100T VA 100W Horn speaker

- The boundary horn speaker TU 100T VA has been developed for areas with extreme high ambient noise and is suitable for indoor and outdoor application, such as tunnels.
- It is built to withstand corrosive atmospheric contaminants, high moisture levels and temperature extremes. The horn provides an enormous sound pressure level, a very balanced frequency response and also a very low distortion.
- The TU 100T VA with a flame retardant plastic housing (UL 94V-0) in black and IP65 protection is also equipped with a ceramic terminal and thermal fuse. The high quality 100W horn driver offers a high performance CCAR voice coil. Furthermore sturdy cable glands 2 x PG13,5 are also provided.
- Sturdy installation by rust-free V4A (A4) stainless steel brackets and screws.
- This horn speaker provides intelligible voice notifications over great distance, resulting in a lower number of loudspeakers which are required. The product is a certified voice alarm speaker according EN 54-24 and there is no additional equalizer needed to meet the frequency response requirements according EN 54-24.



Model	TU 100T VA
Body & grill	ABS
Nominal power	100W
Nominal Impedance	100Ω
Power 100V Line	100 / 50 / 25W
Impedance	100 / 200 / 400Ω
Bandwidth	280 to 9,000Hz
Sensitivity (1W/1m)	113,9dB
SPL MAX 1m	131,9dB
Directivity (H-V) @ 500Hz	58° - 35°
Directivity (H-V) @ 1kHz	35° - 25°
Directivity (H-V) @ 2kHz	40° - 20°
Directivity (H-V) @ 4kHz	54° - 15°
Dimensions (WxDxH)	315 x 305 x 350mm
Weight	16kg
Operating temperature	-25 to +70°C
Protection Index	IP65
Color	Black

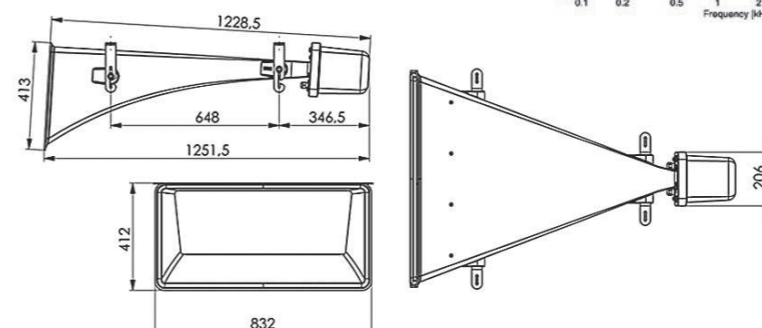
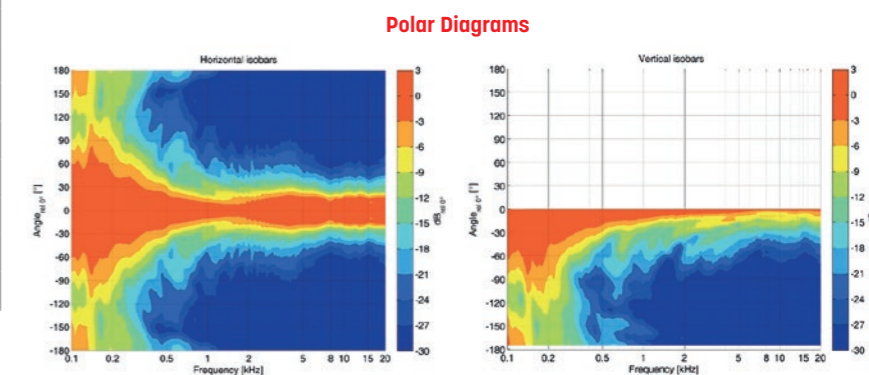
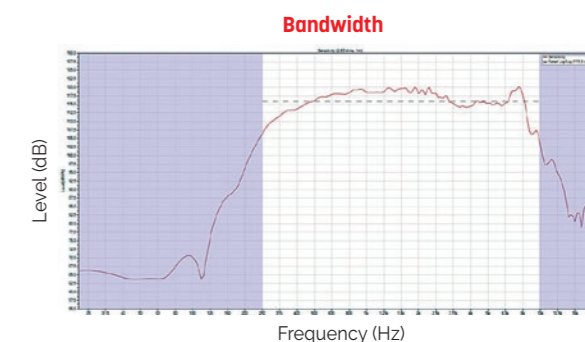

 n° 1438 Certificate n° : 1438-CPR-0908 MAJORCOM: 56 chemin de la Flambrère 31300 TOULOUSE FRANCE	EN 54-24 Speaker for voice alarm systems for systems for fire detection systems and fire alarm systems in buildings
	TU 100T VA
	Type B

CS 532T VA 2-Way Horn Speaker - 30W

- The 30W powered 2-way speaker is equipped with a 100V line transformer with 4 power adjustments 30/15/7.5/3.75W.
- The impact-resistant ABS housing in RAL 7035 guarantees long-term stability.
- For additional reliability, a ceramic block and a thermal fuse is provided.
- The speaker is also secured with the high protection class IP66 against the security risks of environmental influences. Mounting by stainless aluminum universal mount.



Model	CS 532T VA
Body & grill	ABS
Nominal power	100W
Nominal Impedance	100Ω
Power 100V Line	100 / 50 / 25W
Impedance	100 / 200 / 400Ω
Bandwidth	280 to 9,000Hz
Sensitivity (1W/1m)	98.1dB
SPL MAX 1m	112dB
Directivity (H-V) @ 500Hz	58° - 35°
Directivity (H-V) @ 1kHz	35° - 25°
Directivity (H-V) @ 2kHz	40° - 20°
Directivity (H-V) @ 4kHz	54° - 15°
Speaker	5" + Driver
Dimensions (WxDxH)	315 x 305 x 350mm
Weight	16kg
Operating temperature	-25 to +70°C
Protection Index	IP66
Color	White

Bandwidth

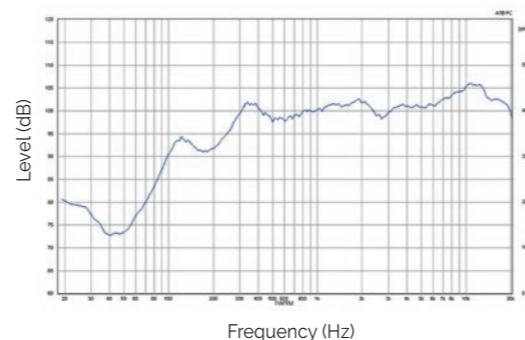

Polar diagrams

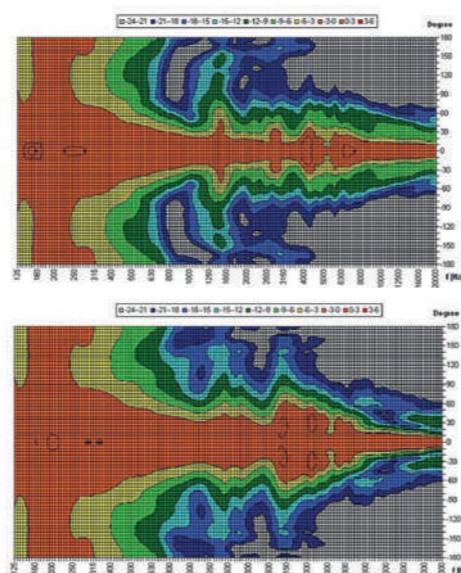

 n°1438 22 Certificate n°: 1438-CPR-0865 MAJORCOM: 56 chemin de la Flambrère 31300 TOULOUSE FRANCE	EN 54-24 Speaker for voice alarm systems for systems for fire detection systems and fire alarm systems in buildings
	CS 532T VA Type B

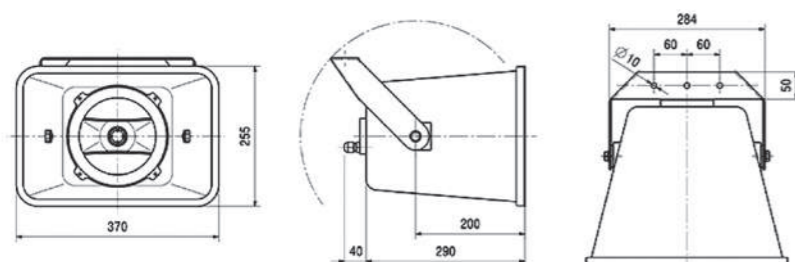

CS-5HTBS 2-Way Horn Speaker - 30W

- The CS-5HTBS long-range enclosure is equipped with a 2-way system, thereby providing a wide frequency range and high sensitivity, making it ideal for the high-quality reproduction of voice and music.
- With its controlled-directivity acoustical horn and two transducers, one for low frequencies and the other for high, this unique rectangular enclosure produces amazingly pure sound.
- The horn is waterproof and can be used in high-humidity environments. It is therefore suitable for outdoor use such as sports fields, stadiums, theme parks, exhibition halls and air terminals, as well as for applications used in P.A and evacuation systems.



Model	CS-5HTBS
Body & grill	ABS fireproof
Nominal power	30W
Nominal Impedance	333Ω
Power 100V Line	30 / 15 / 7.5 / 3.75W
Impedance	333 / 666 / 1,333 / 2,667Ω
Bandwidth	120Hz - 20,000Hz
Sensitivity (1W/1m)	96dB
SPL MAX 1m	111dB
Directivity (H-V) @ 500Hz	140° - 180°
Directivity (H-V) @ 1kHz	60° - 100°
Directivity (H-V) @ 2kHz	90° - 90°
Directivity (H-V) @ 4kHz	90° - 140°
Speaker	6" + 2.5" driver
Dimensions (WxDxH)	315 x 355 x 215mm
Weight	4.65kg
Operating temperature	-25 to +70°C
Protection Index	IP66
Color	White

Bandwidth

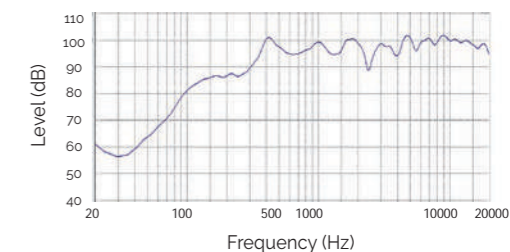

Horizontal directivity

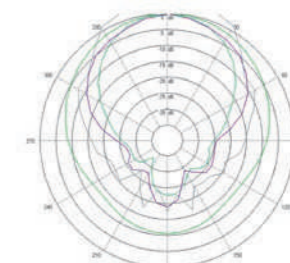

Vertical directivity

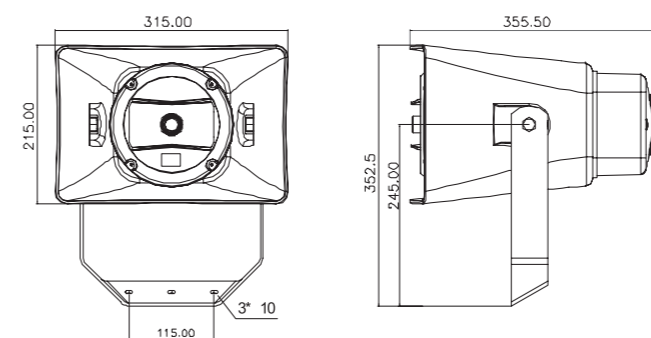
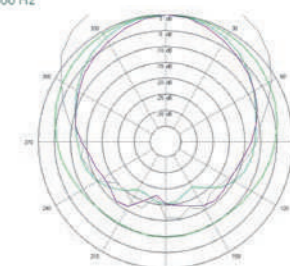

 n°11C Certificate n°: 1488-CPD-0315/W MAJORCOM: 56 chemin de la Flambrère 31300 TOULOUSE FRANCE	EN 54-24 Speaker for voice alarm systems for systems for fire detection systems and fire alarm systems in buildings
	CS-5HTBS Type B

CS-6HT60BS**2-way Horn Speaker - 60W**

- The CS-6HT60BS is equipped with a 2-way system, thereby providing a wide frequency range and high sensitivity, making it ideal for the high-quality reproduction of voice and music.
- With its controlled-directivity acoustical horn and two transducers, one for low frequencies and the other for high, this unique rectangular enclosure produces amazingly pure sound.
- The horn is waterproof and can be used in high-humidity environments. It is therefore suitable for outdoor use such as sports fields, stadiums, theme parks, exhibition halls and air terminals, as well as for applications used in P.A and evacuation systems.

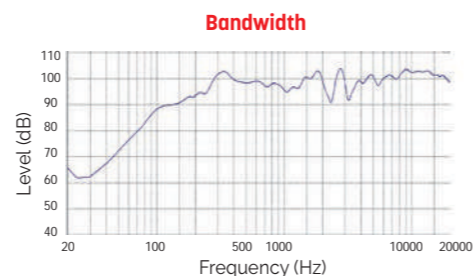
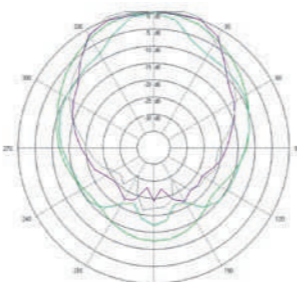
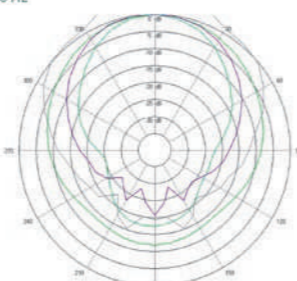
**Horizontal directivity****Vertical directivity**

 n° ITC	EN 54-24
	Speaker for voice alarm systems for systems for fire detection systems and fire alarm systems in buildings
Certificate n° : 1488-CPD-0315/W	
MAJORCOM:	
56 chemin de la Flamèche 31300 TOULOUSE FRANCE	
CS-6HT60BS	
Type B	

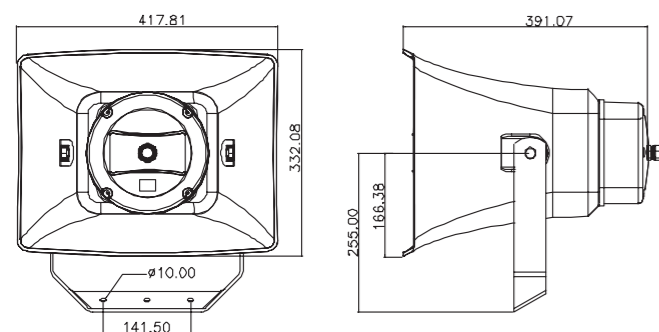

Model	CS-6HT60BS
Body & grill	ABS fireproof
Nominal power	60W
Nominal Impedance	167Ω
Power 100V Line	60 / 30 / 15 / 7,5W
Impedance	167 / 333 / 666 / 1.333Ω
Bandwidth	100Hz - 20kHz
Sensitivity (1W/1m)	98dB
SPL MAX 1m	113dB
Directivity (H-V) @ 500Hz	100° - 140°
Directivity (H-V) @ 1kHz	40° - 70°
Directivity (H-V) @ 2kHz	80° - 90°
Directivity (H-V) @ 4kHz	80° - 150°
Speaker	6,5" + tweeter 2,5"
Dimensions [mm]	(L)332 x (P)391 x (H)418
Weight	7.05kg
Operating temperature	-25 to +70°C
Protection Index	IP66
Color	White

PS 8150T/W VA - PS 8150T/B VA**2-Way Horn Speakers - 150W**

- This 2-way coaxial horn speaker is designed for booth outdoor and outdoor applications !
- EN 54-24 certified, it delivers a superb foreground music.
- The PS 8150T VA delivers a smooth and powerful beam type sound for a large range of venues, such as airports, mega-stores, stadiums and many more.
- The 150W powered professional speaker is equipped with an impressive 2-way bassreflex system, consisting of an 8" woofer and a high performance HF-driver with crossover at 2.5kHz.
- The speaker offers 3 different 100V power tapings 150/75/38W, low impedance operation is also possible.
- The sturdy high-impact ABS housing in white with metal hexagon-shaped aluminium grill offers IP66 enclosure protection.
- Connection is easily done by a screw-terminal at the rear of the speaker, protected by a cover plate with 2 x PG11 cable glands.
- The metal mounting bracket with adjustable inclination enables simple and safe installation. A safety rope is included in the delivery.



PS 8150T/W VA (White)

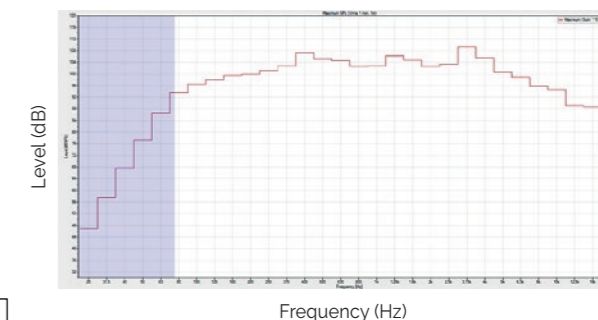

PS 8150T/B VA (Black)

Bandwidth

Frequency (Hz)

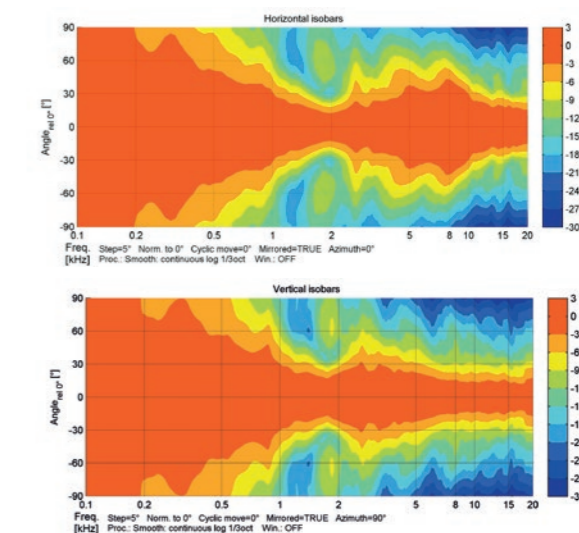
Polar Diagrams

 n° 1438 22	EN 54-24
	Speaker for voice alarm systems for systems for fire detection systems and fire alarm systems in buildings
Certificate n° : 1438-CPR-0855	
MAJORCOM:	
56 chemin de la Flamèche 31300 TOULOUSE FRANCE	
PS 8150T/W VA PS 8150T/B VA	
Type B	

Model	PS 8150T/W VA - PS 8150T/B VA
Body & grill	ABS, Aluminium
Nominal power	150W
Nominal Impedance	67Ω
Power 100V Line	150 / 75 / 38W
Impedance	67 / 133 / 263Ω
Bandwidth	75 - 20,000Hz
Sensitivity (1W/1m)	96,7dB
SPL MAX 1m	116.8dB
Directivity (H-V) @ 500Hz	170° - 180°
Directivity (H-V) @ 1kHz	79° - 80°
Directivity (H-V) @ 2kHz	50° - 62°
Directivity (H-V) @ 4kHz	85° - 70°
Speaker	8" + Driver
Cone	PP polypropylene
Dimensions (WxHxD)	315 x 305 x 350mm
Weight	11.85kg
Operating temperature	-25 to +70°C
Protection Index	IP66
Color	White

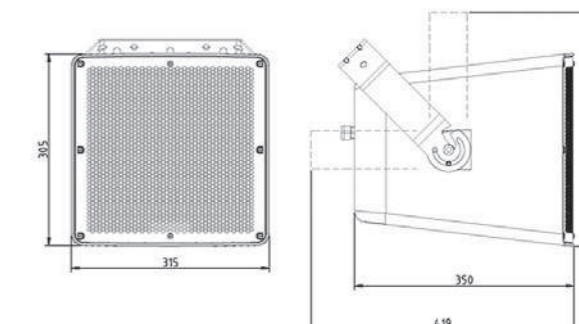

PS 8250T/W VA - PS 8250T/B VA 2-Way Horn Speakers - 250W

- This 2-way coaxial horn speaker is designed for booth outdoor and outdoor applications !
- EN 54-24 certified, it delivers a superb foreground music.
- The PS 8250T VA delivers a smooth and powerful beam type sound for a large range of venues, such as airports, mega-stores, stadiums and many more.
- The 250W powered professional speaker is equipped with an impressive 2-way bassreflex system, consisting of a 12" woofer and a high performance HF-driver with crossover at 2.5kHz.
- The speaker offers 3 different 100V power tapings 250/125/63W, low impedance operation is also possible.
- The sturdy high-impact ABS housing with metal hexagon-shaped aluminium grille offers IP66 enclosure protection.
- Connection is easily done by a screw-terminal at the rear of the speaker, protected by a cover plate with 2 x PG11 cable glands.
- The metal mounting bracket with adjustable inclination enables simple and safe installation. A safety rope is included in the delivery.

 n°1438 22 Certificate n° : 1438-CPR-0855 MAJORCOM: 56 chemin de la Flamrière 31300 TOULOUSE FRANCE	EN 54-24 Speaker for voice alarm systems for systems for fire detection systems and fire alarm systems in buildings
	PS 8250T/W VA PS 8250T/B VA Type B

Model	PS 8250T/W VA - PS 8250T/B VA
Body & grill	ABS, Aluminium
Nominal power	250 W
Nominal Impedance	40 Ω
Power 100V Line	250 / 125 / 63 W (80 Ω)
Impedance	40 / 80 / 158 Ω
Bandwidth	75 - 20,000Hz
Sensitivity (1W/1m)	98,5 dB
SPL MAX 1m	122,5 dB
Directivity (H-V) @ 500Hz	138° - 152°
Directivity (H-V) @ 1kHz	60° - 70°
Directivity (H-V) @ 2kHz	90° - 110°
Directivity (H-V) @ 4kHz	80° - 70°
Speaker	12" + Driver
Cone	PP polypropylene
Dimensions (WxHxD)	390 x 425 x 418 mm
Weight	18,9 kg
Operating temperature	-25 to +70°C
Protection Index	IP 66
Color	White / Black

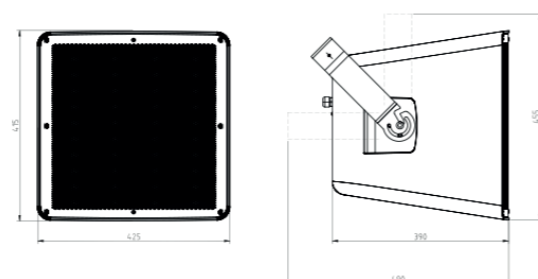
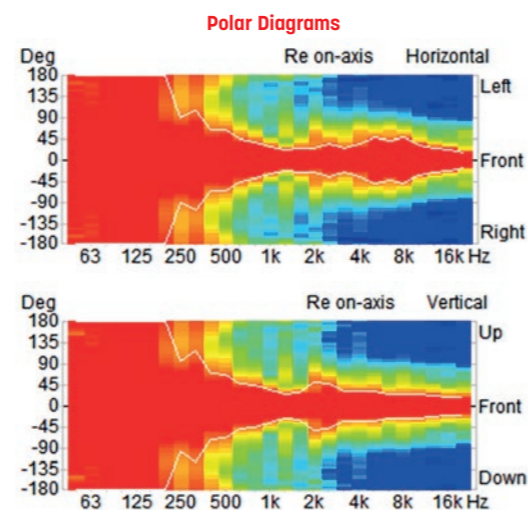
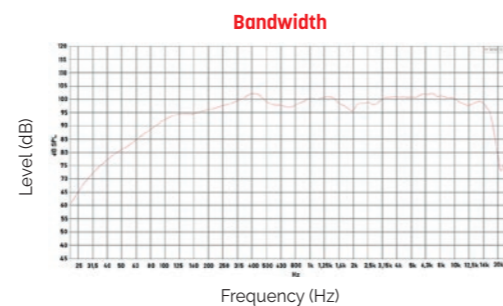



XS 100T VA Compact Power Speaker 25/50/100 W

- The XS 100T VA is a compact power speaker, with waveguide technology. Whether sports venues, exhibition halls or stages, the XS 100T VA offers an exceptional sound experience with excellent speech intelligibility, certified according to EN 54-24.
- Built in an impact-resistant ABS housing with an aluminium grille, the XS 100T VA is available in white. The 100W speaker is equipped with two 4" performance mid-bass woofers, a 2-way bass reflex system and a high-performance tweeter including a waveguide.
- A tweeter switch provides a 4dB boost for possible sound correction in near-wall and near-ceiling installations. The loudspeaker offers 4 different 100V power adjustments. Low-impedance operation is also possible.
- The loudspeaker is weatherproof with IP66 protection rating. A sturdy aluminium bracket ensures flexible mounting, indoors as well as outdoors.
- **This loudspeaker is also available as a professional line array (XS 100T VA ARRAY).**

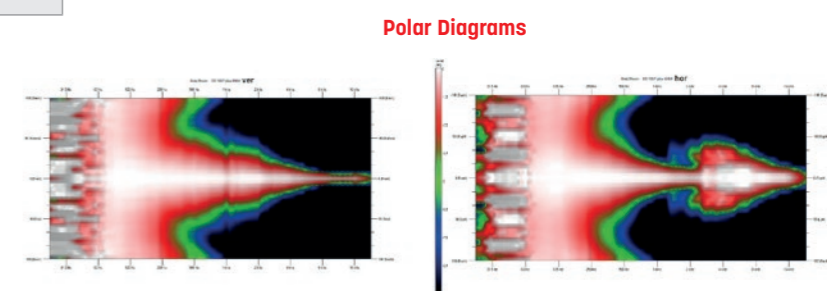
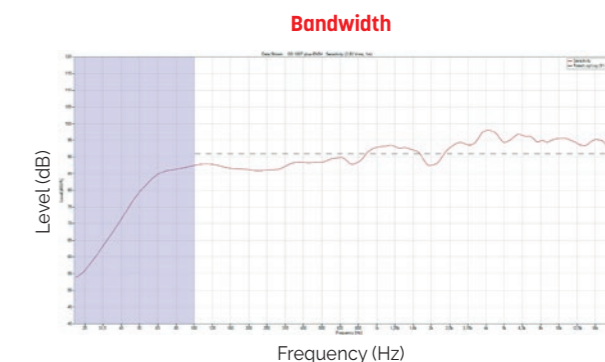
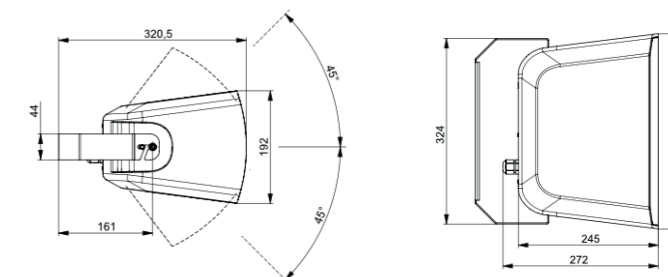

Model	XS 100T VA
Power	25/50/100 W
Impedance (100V)	100/200/400 or 1x4 Ω
Bandwidth	49-22.000 Hz
SPL, Pmax/4m	95,1 dB
Sensitivity (1W/1m)	86,3 dB
Directivity (H-V) -6dB, 500Hz	160° - 230°
Directivity (H-V) -6dB, 1KHz	65° - 140°
Directivity (H-V) -6dB, 2KHz	120° - 100°
Directivity (H-V) -6dB, 4KHz	145° - 68°
Dimensions	341 x 245 x 192 mm
IP Rating	IP66
Weight	6,5 kg
Temperature range	-25 / +70 °C
Mounting	Mounting bracket (included)
Connector	Screw terminal
Terminal diameter	2,3 mm
Maximum cable passage	4 mm ²
Colour	White



 n°1438 22 Certificate n° : 1438-CPR-1023 MAJORCOM: 56 chemin de la Flamrière 31300 TOULOUSE FRANCE	EN 54-24 Speaker for voice alarm systems for systems for fire detection systems and fire alarm systems in buildings
	XS 100T VA Type B

XS 100T VA ARRAY

Compact Line Array 4x100 W



- The XS 100T VA ARRAY combines the strengths of the XS 100T VA into a loudspeaker system that is able to cover even larger areas with excellent speech intelligibility, certified according to EN 54-24. This compact line array consists of 4 modules in a steel bracket. Each module can be adjusted in 3 vertical steps : 0, 5, 10 and 15°. This makes it adaptable to all acoustic challenges, indoors and outdoors. The loudspeaker is weatherproof with an IP66 protection rating. A safety rope is included.

- Built in an impact-resistant ABS housing with an aluminium grille, the XS 100T VA ARRAY is available in white. Each of the 100W speakers is equipped with two 4" performance mid-bass woofers, a 2-way bass reflex system and a high-performance tweeter including a waveguide.

- A tweeter switch provides a 4dB boost for possible sound correction in near-wall and near-ceiling installations. Each loudspeaker offers 4 different 100V power adjustments. Low-impedance operation is also possible.

- These loudspeakers are also available individually (XS 100T VA).

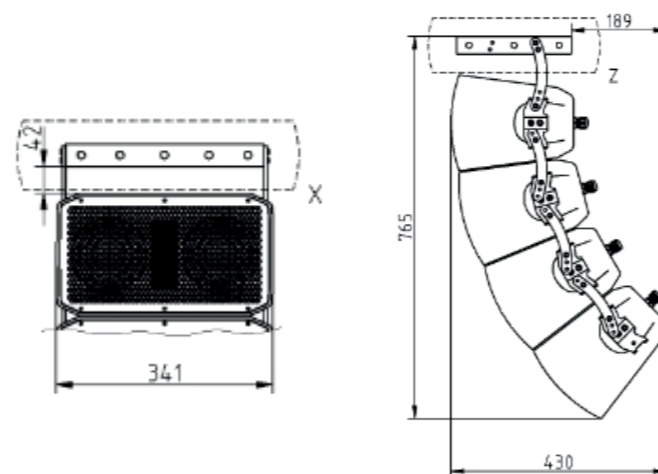

Model	XS 100T VA ARRAY
Power	4 x 100/50/25 W
Impedance (100V)	4 x 100/200/400 or 1x4 Ω
Bandwidth	50-22.000 Hz (Tweeter odB)
Sensitivity (1W/1m)	92 dB
Directivity (H-V) -6dB, 500Hz	182° - 62°
Directivity (H-V) -6dB, 1KHz	78° - 30°
Directivity (H-V) -6dB, 2KHz	82° - 11°
Directivity (H-V) -6dB, 4KHz	175° - 10°
Dimensions	0° : 341 x 852 x 274 mm 45° : 341 x 765 x 430 mm
IP Rating	IP66
Weight	30 kg
Mounting	Mounting bracket (included)
Connector	Screw terminal
Terminal diameter	2,3 mm
Maximum cable passage	4 mm ²
Colour	White

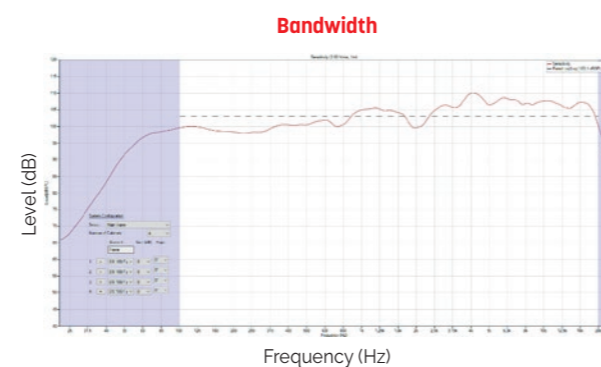

 n°1438 22 Certificate n° : 1438-CPR-1023	EN 54-24 Speaker for voice alarm systems for systems for fire detection systems and fire alarm systems in buildings
	XS 100T VA ARRAY Type B
MAJORCOM: 56 chemin de la Flambe 31300 TOULOUSE FRANCE	

PUBLIC ADDRESS SYSTEMS

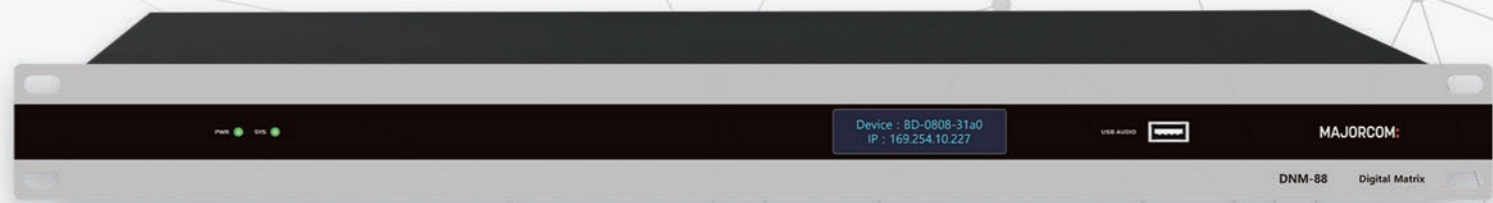



We have developed a network converter system according to the demand of market to control in integrated way independent broadcasting systems distributed to wide regions by linking each other. There are many difficulties in costs, efficiency, and time aspects to change all of established existing equipment and to introduce a new system.

The new network system can link or extend other total products as well as Inter-M equipment including already installed 6000 system, NPX system, and ARM-911A, and can control each region in integrated way.

In addition, it provides easy wiring and installation with the operation of system based not on line method of wiring but on TCP/IP network, and can control the whole system in convenient and integrated way through a control program based on web control method.

Introduction of Network Converters

A network converter system is a system expandable over 512 zones based on 48 sources (24 tone generating devices / 24 remote microphones) input and 24 buses output. This system enables to link each other in independent space and many places and to control in wide and integrated method.

In addition, when it is needed to extend to additional equipment, it can extend simply even in any place where the network is connected.

The network converter system enables the output to various zones with only one amplifier and can diversify by zone using one amplifier to one zone. It can be installed with a simple hardware installation and its detailed setting is completed with the software.

User can build network-based integrated systems by adding network converters to existing analog devices.

User can configure optimized system for various environment of requirement when expanding and integrating a broadcasting system.



Product Line-up

Model	Description	Remark
NCS-1000	Network Control Server	Main Network Management Server
NC-600	6000 1BUS/8BUS Network Converter	6000 1/8 BUS Converter
NC-S01	Source Network Converter	Source Converter (CD Player, Tuner, etc.)
NC-M01	Remote MIC Network Converter	Remote MIC Converter
MS-N300	Network Control Software	Main Network Management Program

Intuitive Interface

It provides familiar and accustomed user environment through similar GUI with MS-6800, a software of existing 6000 system.

You can monitor all equipment connected to the network and can control a variety of broadcasting regions equipments via intuitive interface.

Menu - Equipment Monitoring

You can check and control the status of equipment via equipment monitoring menu.



GUI Optimal to Environment

It provides [Setting Menu] for providing GUI optimized to environment and provides [Operating Menu] for operating the actual broadcasting when installing the broadcasting system.

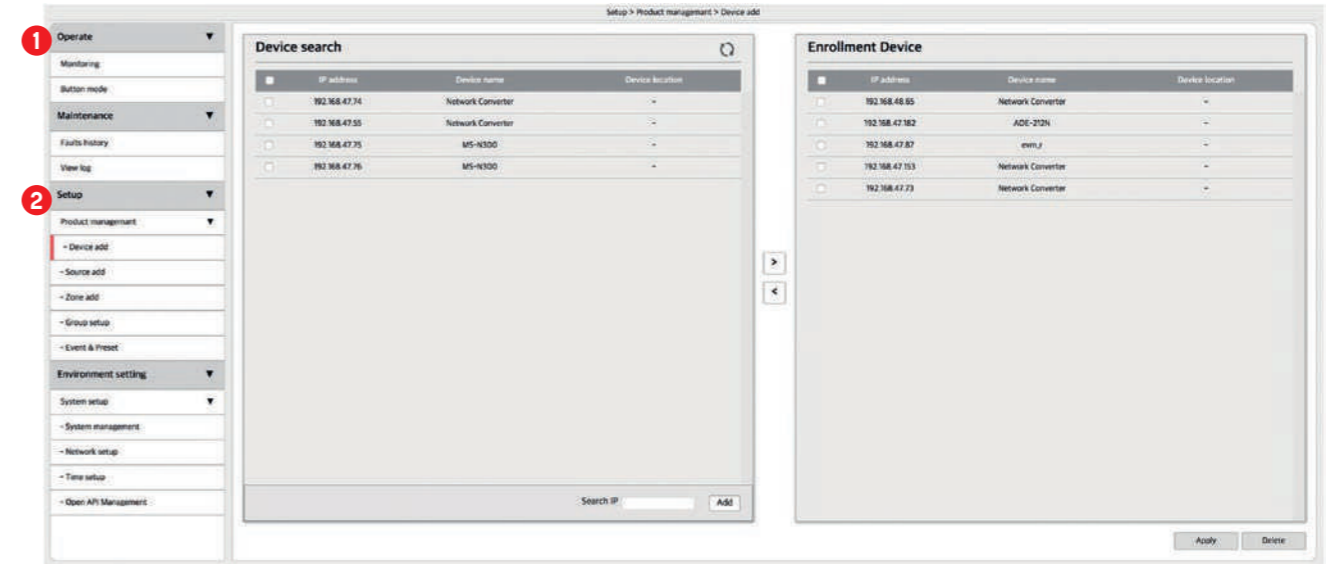

1 You can select the source of zone and can control the broadcasting from operating menu.

2 You can search the equipment via network to register or can configure & group the zone in the broadcasting region from setting menu.

Menu - Button Mode

Under button mode, you can select the tone generator via registered source equipment to send by each group and region. You can adjust the tone generator and control the contact.

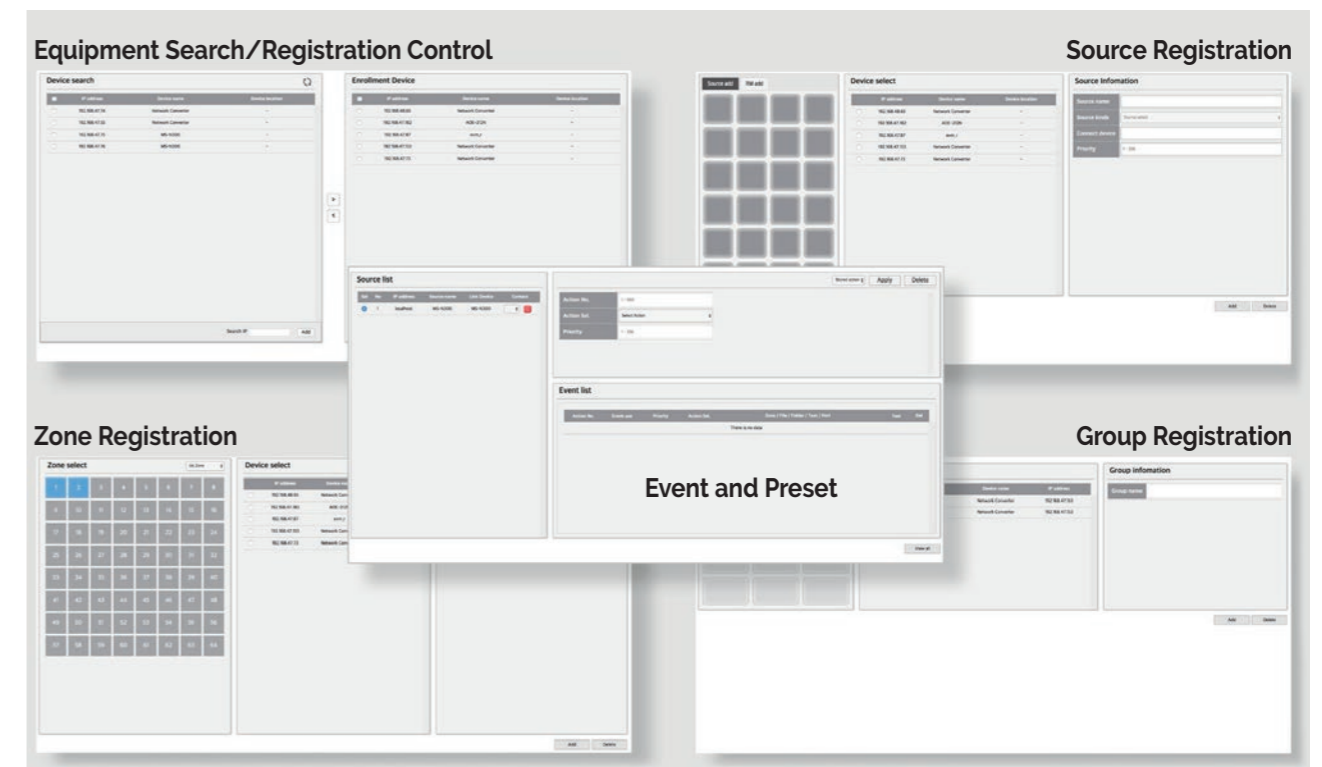
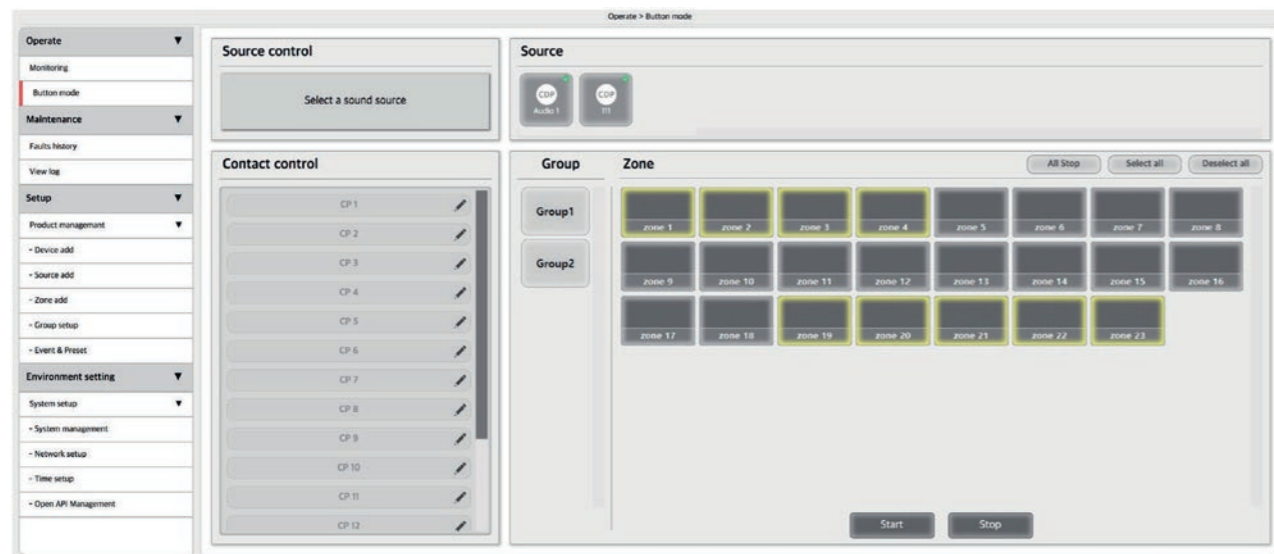

NCS System components

NCS-1000



Main Network Management Server

- NCS-1000 is a server to control all equipment connected with the network as a hardware equipment for integrated network control.
- Controls all sound & video equipment connected to network in integrated method.
- Equipment control connected to the network.
- Applies a standard network protocol.
- Supports DHCP, STATIC IP (Default setting: STATIC IP, 192.168.1.99).
- Supports network redundancy.
- Provides web-based integrated control software (MS-N300).

Model	NCS-1000
Network Communication	10/100/1000 Base-T (RJ-45)
Operating Temperature	0°C ~ +40°C
Power Source	120~240V, 50/60Hz, 10W, DC 24V, 350mA
Dimensions (WxHxD)	482 x 44 x 280mm
Weight	3kg

Front panel



- 1 Network (primary,secondary) LED
- 2 OLED display
- 3 Display mode switch
- 4 Power LED

Rear panel



- 1 AC inlet
- 2 AC power switch
- 3 DC power connection terminal
- 4 Network (secondary) connection terminal
- 5 Network (primary) connection terminal
- 6 Factory reset switch

NCS System components

NC-600



6000 1/8 BUS System Converter

- NC-600 is an equipment to send audio, contact, and data signal to network for integrated network control of 6000 1/8 Bus system.
- PX-6216/ECS-6216P RM Interface via network.
- Contact terminal interface of ECS-6216MS via network.
- Sends/receives Audio (MP3, PCM, RTSP) via network.
- Supports DHCP, STATIC IP (Default setting: STATIC IP, 192.168.1.99).
- Supports network redundancy.

Model	NC-600	
AUDIO	Audio Input	1 Channel
	Audio Output	1 Channel
	Input Sensitivity	0dBV
	Frequency Response	20Hz ~ 20kHz
	THD+N ratio (20kHz LPF, 0dBV, 1kHz)	< 0.1%
	S/N (20kHz LPF, 0dBV, 1kHz)	> 80dB
	Sampling Frequency	44.1, 48kHz
Contact Closure	Contact Closure Output	16 Channel
Communication	Serial Communication	RS-422
		10/100/1000 Base-T (RJ-45)
Operating Temperature	0°C ~ +40°C	
Power Source	DC 24V, 550mA	
Dimensions (WxHxD)	482 x 44 x 280mm	
Weight	2.9kg	

Front panel



- 1 Network (primary,secondary) LED
- 2 OLED display
- 3 Display mode switch
- 4 Power LED

Rear panel



- 1 DC adapter connection terminal
- 2 Contact closure output terminal
- 3 PX-6216 / ECS-6216P connection terminal
- 4 Audio input terminal
- 5 Audio output terminal
- 6 Network (secondary) connection terminal
- 7 Network (primary) connection terminal
- 8 Factory reset switch

NC-S01



Source Device Converter

- NC-S01 is an equipment to control source equipment like CD player and Tuner with network in integrated way.
- RS-232C control via network (remote control of source equipment, CD-6208).
- Audio (MP3, PCM, RTSP) sending via network.
- Supports DHCP, STATIC IP (Default setting: STATIC IP, 192.168.1.99).
- Supports network redundancy.
- 1U Half Rack Size.

Model		NC-S01	
AUDIO	Audio Input	1 Channel	
	Input Sensitivity	CD INPUT	6 ±3dBV
		RM-6024	0 ±3dBV
	Frequency Response	20Hz ~ 20kHz	
	THD+N ratio (20kHz LPF, 0dBV, 1kHz)	< 0.1%	
	S/N (20kHz LPF, 0dBV, 1kHz)	> 80dB	
Sampling Frequency	44.1, 48kHz		
Communication	Serial Communication	RS-232, RS-422	
	Network Communication	10/100/1000 Base-T (RJ-45)	
Operating Temperature		0°C ~ +40°C	
Power Source		Input: DC 24V, 800mA // Output: DC 24V, 500mA	
Dimensions (WxHxD)		210 x 44 x 180mm	
Weight		1kg	

Front panel

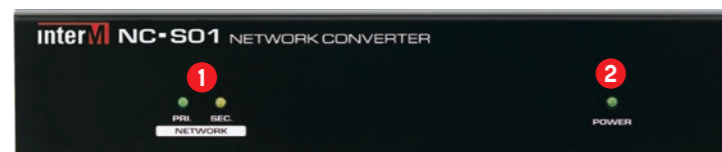

- 1 Network (primary, secondary) LED 2 Power LED

Rear panel



- 1 DC adapter connection terminal 2 DC input power connection terminal
 3 DC output power connection terminal 4 Audio input terminal 5 RM-6024 connection terminal
 6 RS-232 connection terminal 7 Network (secondary) connection Terminal
 8 Network (primary) connection Terminal 9 Factory reset switch

NC-M01



Remote MIC Converter

- NC-M01 is an equipment to send audio, contact, and data signal to network for integrated network control of remote MIC such as RM-6016.
- Contact interface of RM-6016 via network.
- Audio (MP3, PCM, RTSP) sending via network.
- Supports DHCP, STATIC IP (Default setting: STATIC IP, 192.168.1.99).
- Supports network redundancy.
- 1U Half Rack Size.

Model		NC-M01
AUDIO	Audio Input	1 Channel
	Input Sensitivity	0dBV
	Frequency Response	20Hz ~ 20kHz
	THD+N ratio (20kHz LPF, 0dBV, 1kHz)	< 0.1%
	S/N (20kHz LPF, 0dBV, 1kHz)	> 80dB
	Sampling Frequency	44.1, 48kHz
Contact Closure	Contact Closure Output (NC-M01)	16 Channel
Communication	Network Communication	10/100/1000 Base-T (RJ-45)
Operating Temperature		0°C ~ +40°C
Power Source		Input: DC 24V, 800mA // Output: DC 24V, 500mA
Dimensions (WxHxD)		210 x 44 x 180mm
Weight		1kg

Front panel

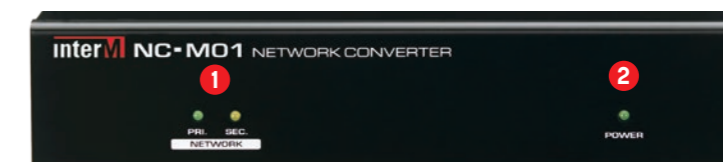

- 1 Network LED (primary, secondary) 2 Power LED

Rear panel



- 1 DC adapter connection terminal 2 DC input power connection terminal
 3 DC output power connection terminal 4 Contact closure input terminal
 5 Audio input terminal 6 Network (secondary) connection Terminal
 7 Network (primary) connection terminal 8 Factory reset switch

PM-N108

Remote PA Monitor



- PM-N108 is a system audio monitoring equipment via network when long distance network PA or mass PA system is configured.
- ETHERNET Gigabit 100/1000Mbps.
- Receiving audio source by network.
- Monitoring of 8 line channel audio inputs.
- Monitoring of 8 100V amplifier channels.
- Boundless expansion by network.
- Web-based setting.
- The equipment can check power amplifier output and status of line level audio via PC or mobile devices..
- Also, status of total system can be monitored in real time.

Model	PM-N108	
AUDIO	Audio Input Channel	8CH
	Audio Input Level	0dBV (1Vrms)
	Frequency Response (0dBV)	20Hz ~ 20kHz
	THD+N Ratio (20Hz HPF, 20kHz LPF, 0dBV, 1kHz)	Less than 0.1%
	S/N (20Hz HPF, 20kHz LPF, 0dBV, 1kHz)	More than 80dB
	100V Amplifier Input Channel	8CH
	Amplifier Input Level	40dBV (100Vrms)
	THD+N Ratio (20Hz HPF, 20kHz LPF, 40dBV, 1kHz)	Less than 1%
Network Communication		100/1000 Base-T
Operating Temperature		0°C ~ 40°C
Power Source		24 V DC, 300mA
Dimensions (WxHxD)		482 x 44 x 280mm
Weight		3.04kg



Rear panel

PN-106 / PN-112 / PN-236 / PN-260

Amps-preamps



- The PN Series amplifiers are amps-preamps that allow audio streams to be received remotely over the IP network.
- They can be deployed in various locations without constraint of cables and are controlled remotely via the NCS system (management of priorities of audio inputs, volume control, audio file management...).
- They are ideal for schools, industrial buildings, chain of stores...

Model	PN-106	PN-112	PN-236	PN-260
Nominal power RMS	60W	120W	360W	600W
Bandwidth (1W, 0±3dB)	80 to 15,000Hz			
THD @ 1kHz	< 1%			
S/B (A-WTD) @1kHz	LINE / Audio		70dB	
	MIC		55dB	
Input sensitivity / Impedance	Input 1	MIC	-60dBV / 2kΩ (Balanced)	
	Input 2	LINE	0dBV / 24kΩ (Unbalanced))	
		MIC	-60dBV / 2kΩ (Balanced)	
	Network	Audio	-2.2dBV	
Output Impedance	100V / 166Ω	100V / 84Ω	100V / 27.7Ω	100V / 16.6Ω
	70V / 82Ω	70V / 41Ω	70V / 13.6Ω	70V / 8.1Ω
	22V / 8Ω	22V / 4Ω	38V / 4Ω	49V / 4Ω
Network communication	100/1000 base-T (RJ-45)			
Operating Temperature	-10°C ~ +40°C			
Power source	120-240V AC, 50/60Hz		220-240V AC, 50/60Hz	120-240V AC, 50/60Hz
Consumption	55W		110W	150W
Dimensions (WxHxD)	420 x 44 x 320mm		420 x 88 x 320mm	
Weight	4.49kg		5.02kg	5.23kg
Accessorie (optional)	Rack mount brackets BKT-DSA100D-F		Rack mount brackets BKT-A120	



PN-106 / PN-112 rear panel



PN-236 / PN-260 rear panel

RM-N3000

- RM-N3000 is a network only remote MIC station for paging broadcasting to each zone which can network broadcasting by select AOE / VoIP / AVB protocol.
- In addition, users can easily set options, select zone and broadcast with high resolution OLED, 10-KEY button on the front panel.
- MIC/external input (AUX) selectable broadcast
- Automatic chime broadcasting
- Configurable 5 Preset buttons
- Output LEVEL METER LED
- Audio output via built-in speaker
- DC 24V (adapter available)
- Supporting VoIP / AVB / AOE streaming
- Supporting 100 / 1000Mbps
- Supporting DHCP, STATIC IP
- Supporting network bonding (AOE)



IP Remote Microphone

- RM-N3000 can be connected to the AOE network through the rear network terminal without any converters.
- Even if the first network fails, stable broadcasting is possible to the second network due to network redundancy.

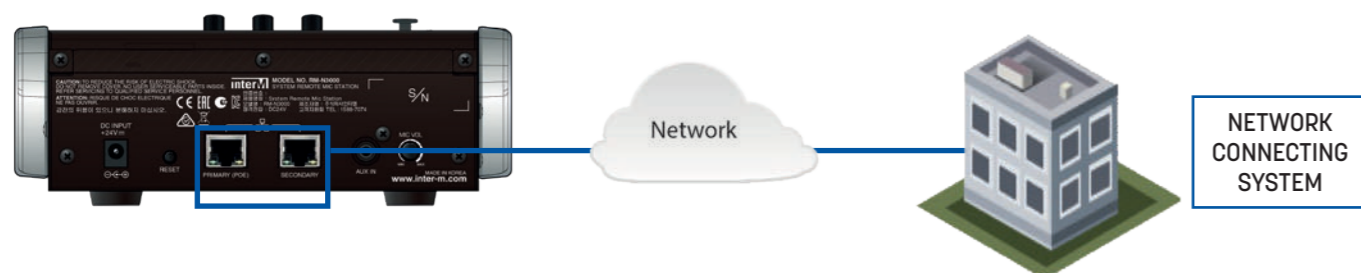

- Macro broadcasting max 1024 Zone
- STATIC/DHCP/ZEROCONFIG
- 100/1000 Network
- Support network **bonding** (AOE TCP MODE)

Teaming or **bonding** of network interfaces a server is used to combine 2 network interfaces in one virtual network interface. The network interface thus obtained can be configured as a normal network card.

One of the advantages is that in case of failure of a network card, the virtual interface continues to function as if nothing had happened. Another important advantage is that the ability 2 cards forming the virtual network interface can be combined to split the speed of your network connection.

Model	RM-N3000
Input sensitivity	MIC: -50dBV / AUX: -10dBV
Output level	0dB
S/N (<22kHz LPF)	MIC > 70dB / AUX > 80dB
THD (<22kHz LPF)	< 0.1%
Bandwidth	100 to 18,000Hz (+/-3dB)
Communication	Ethernet Network (100Mo / 1Go)
Power Source	24VDC
Consumption	Max. 10W
Dimensions (without Mic)	200(X) x 73(H) x 206(D)mm
Operating T°	-10°C ~ +40°C
Weight	1.29kg

ALIM 24VDC 1.25A
220V/24VDC - 1.25A - 30W
power supply



MS-N300



Integrated Control Software

MS-N300 is a control program of NCS-1000, a main server and it can control & monitors the whole system easily via web page.



GUI style & button type broadcasting operation of 6000 system



Synchronizing of internet time



Extending the broadcasting zone with 24 source MICs and 512 remote MICs



Equipment updating via web



Sending of remote equipment and monitoring of tone generator



Load & Save function of equipment settingdB



Editing of source and zone information



Applying 256 bit security access key



Editing of events and broadcasting preset motions

How to Use Software MS-N300

Equipment Monitoring

As a window for administrator to operate, it is possible to check the status of equipment connected to network.

To monitor devices on the network, each device should be registered using Device management menu in advance.

1 Source equipment

It indicates a source equipment list connected to network and thus, user can check easily.

Source device				
A	B	C	D	
Name	Location	IP	Connect	
<input type="radio"/>	NCS-6800	Network Server	localhost	■
<input type="radio"/>	NC-S01_AI	CD6208 Source output	192.168.47.215	■
<input type="radio"/>	Network Converter	-	192.168.47.48	■
<input type="radio"/>	Network Converter	-	192.168.47.76	■
<input type="radio"/>	NC-M01_ALCI	RM6016 Contact Input	192.168.47.214	■

- A/** Equipment Name: It indicates the equipment name of registered source equipment.
- B/** Position: It indicates the position of registered source equipment.
- C/** IP: It indicates IP of registered source equipment.
- D/** Connection Status: It indicates the connection status of registered source equipment as green & red LEDs.

2 Output equipment

It indicates status & manipulation of output equipment connected to network and makes the user manage easily.

Output device							
A	B	C	D	E	F	G	H
Name	Location	IP	Connect	Output	Mute	Volume	Level Meter
NC-600_CO	Only Contact output	192.168.47.239	■	■	Mute	45	<div style="width:45%; background-color: #ccc; border: 1px solid #ccc;"></div>
NC-900_AO.CO	6000 Analog	192.168.47.227	■	■	Mute	100	<div style="width:100%; background-color: #ccc; border: 1px solid #ccc;"></div>
NC-600_AO_RO	6000 8인화	192.168.47.238	■	■	Mute		<div style="width:0%; background-color: #ccc; border: 1px solid #ccc;"></div>
NC-600_AO	Only Audio output	192.168.47.236	■	■	Mute		<div style="width:0%; background-color: #ccc; border: 1px solid #ccc;"></div>

- A/** Equipment Name: It indicates the equipment name of registered output equipment
- B/** Equipment: It indicates the position of registered output equipment
- C/** IP: It indicates IP of registered output equipment
- D/** Connection Status: It indicates the connection status of registered output equipment as green & red LEDs
- E/** Output: It indicates the output status of registered output equipment. Display green LED if it is on output, otherwise display red LED.
- F/** Mute: When pressing Mute button, the background of button is changed as red together with mute function
- G/** Volume: You can adjust the volume from 0 to 100 using volume control bar
- H/** Level Meter: It displays broadcasting output level meter

How to Use Software MS-N300

Button Operating Mode

1 Source control

The image of selected source device (CD or TUNER) is displayed.



CD control window



TUNER control window

2 Source selection

It is a window to select the source meeting the requirements of user.

Source type				Source status
				<input checked="" type="checkbox"/>
CD player	BGM (other source)	Tuner (RS232C)	RM (Mic console)	Network connected: Source device can be controlled remotely
				<input type="checkbox"/>
				Network disconnected: Unable to control source device remotely

3 Contact control

- Contacts selected in Event&Preset are activated and displayed on the list.
- Up to 16 virtual contacts can be set up.
- Contact can be selected in Event & Preset to be applied to a certain OUTPUT zone.
- When clicking on an activated contact, broadcasting is outputted to selected OUTPUT zones without clicking START BROADCASTING button.
- Clicking on an activated contact(1-16), the name of contact can be changed.

How to Use Software MS-N300

Button Operating Mode (following)

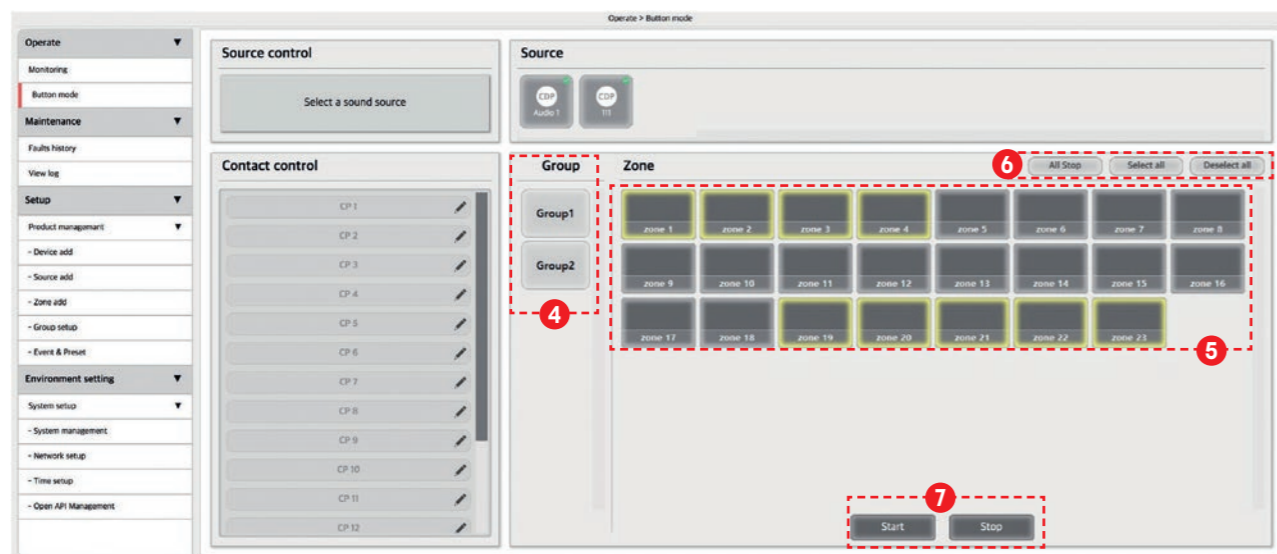

4 Group selection

- The image of selected source device (CD or TUNER) is displayed.
- Group selection is possible in the range of Group 1 ~ 12 and you can view the group number list by scrolling the right BAR up/down.
- When selecting the group with the preset group information, the region is selected.
- Multiple selection is possible.

5 Zone selection

- When selecting directly group selection or zone, the selected zone indicates the border to divide the selection.
- When re-selecting the selected zone, the selection is canceled.

6 End all broadcastings - Select all - Deselect all

- End all broadcastings: All priority broadcastings are reset and terminated. Please note that priorities set in Event & Preset are preserved.
- All selection: All regions are selected.
- Canceling all selection: The selection of all regions is canceled.

7 Broadcasting start/end

- Broadcasting start: The selected tone generator is sent to the selected region.
- Broadcasting end: The sending broadcasting is ended.

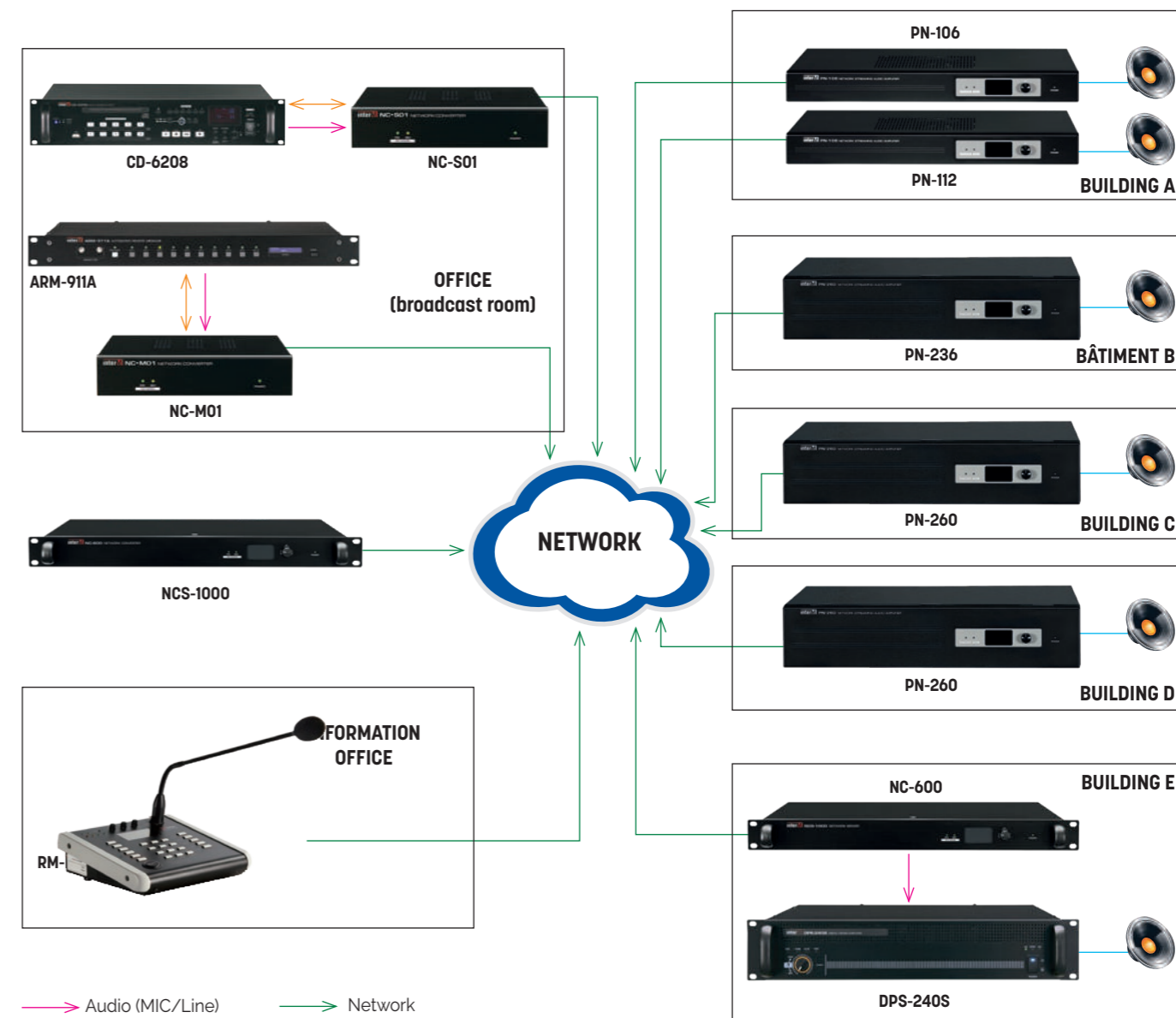

→ Audio (MIC/Line) → Network
↔ RS-232, 422, 485, USB — 100V Speaker line



NETWORK MESSAGES READER

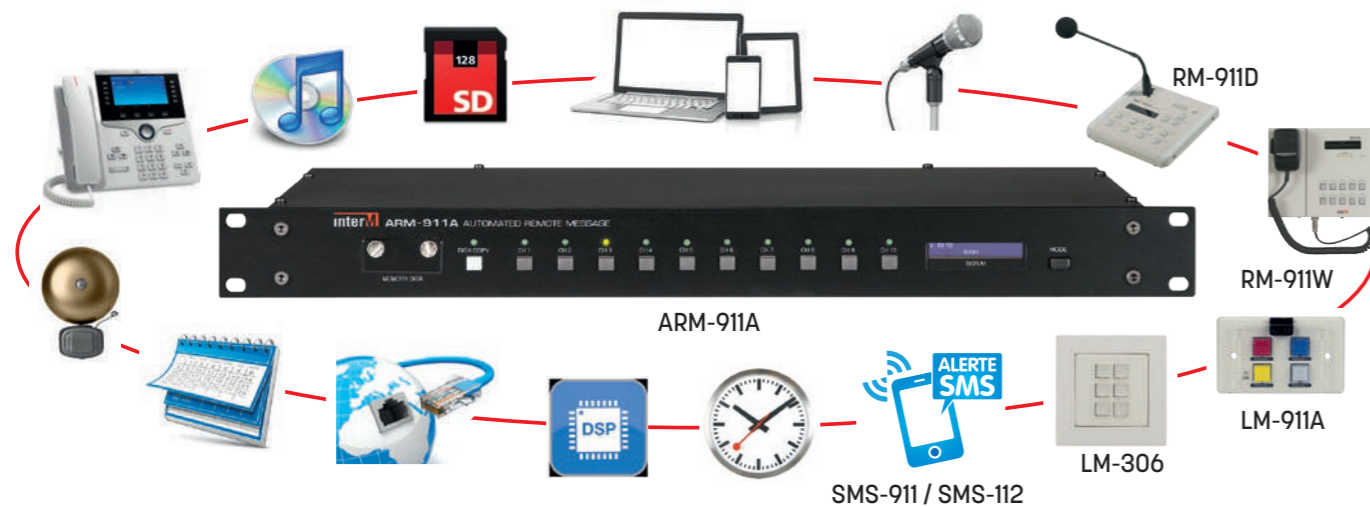

RM-911D
Desktop
Microphone



RM-911W
Wall-Mount
Microphone



LM-911A
4-message
trigger plate



LM-306
Message triggering
IP (PoE) plate



SMS-112
GPRS or 4G/LTE
Modem, WiFi, 6
inputs/4 outputs
dry contact



SMS-911
3G/4G SMS
Module

- The ARM-911A meets the public address and voice alarm messaging requirements of small and medium-sized installations. It is a high performance and very versatile standalone automated network message reader. It is an ideal complement to any existing or new public address system and allows easy initiation of emergency message broadcasting and containment and PPMS procedures and much more.
- Up to 4 remote microphones can be connected to the ARM-911A. The microphone can be used for instantaneous live voicemail. The 10 buttons on the microphone console are used to activate the various messages. A TEL IN input allows the ARM-911A to be connected to a PABX via a SIP TEL MOD for triggering messages from any telephone set.
- Each input features volume controls, high pass filter, programmable EQs and user input settings, and priority level

adjustment. The 2 auxiliary inputs can accommodate any type of source: a wireless microphone, a music source, the reception of audio content from other equipment. Ten dry contacts or alarm inputs make it possible to obtain an external trigger in order to broadcast a pre-programmed message or from any remote device (microphone console; web page, front panel, telephone; dry contact, etc.)

- An integrated programmable TIMER makes it possible to plan the reading of messages or playlists recorded on internal non-volatile memory. Files can be transferred from a web browser. The ARM-911A can also be used for starting and ending bells in schools, broadcasting safety messages and signals and for automatic message playback.



ARM-911A rear panel

Remote microphone Station

It is possible to connect to the ARM-911A up to 4 remote microphone desks. The microphone can be used for instantaneous live voicemail. 10 buttons on the microphone station are used to activate different messages. A 4-digit security code can be programmed to prevent unauthorized use of the paging station.



RM-911D: desktop type

RM-911W: wall-mount type

Web Browser Configuration

The ARM-911A is installed, configured and managed using an easy to use web browser interface.

- Setting up the network configuration
- Source priority configuration
- Adjustment of source level, HPF and equalizer
- Output level adjustment
- Programmable timer
- Remote Microphone Setup

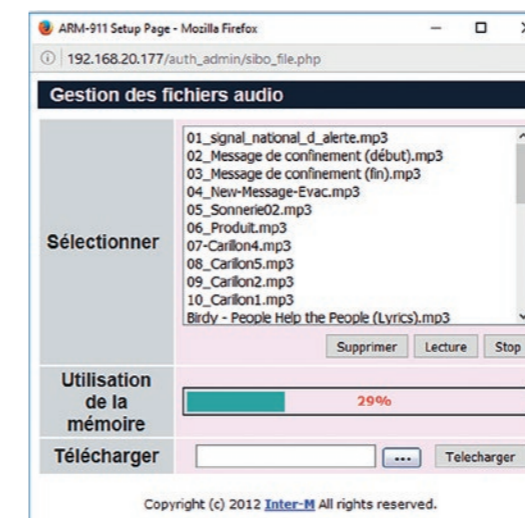

Telephone Paging

TEL-IN input on the back of the ARM-911A allows you to connect a MOD TEL 2 or MOD TEL SIP: the first operates on an analog telephone line via a PABX, the second operates on a VoIP network Through an IP PBX. Thus, whatever your installation, you can make an audio call or trigger one of the 10 messages of the ARM-911A from any telephone handset.



NTP (Network Time Protocol)

NTP enables automatic time synchronization. The ARM-911A's internal clock is updated and synchronized with external server clocks. This improves the accuracy of timer programming events to broadcast. The accuracy of time broadcasts is important. MP3 file names for timer event programming can now contain special characters. This gives users more flexibility, especially for multilingual file names.

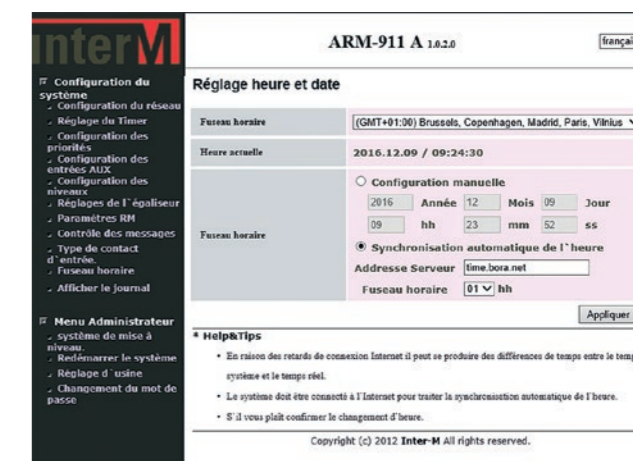

SMS Alert

The SMS-112 (GPRS or 4G/LTE, WiFi) or SMS-911 (3G/4G) modules are very simple modules, used to be alerted by an SMS in the event of an anomaly or in the event of an evacuation alert, PPMS, chemical risk..

You can also send an SMS from your mobile phone to trigger a specific contact which itself will trigger an evacuation message or other message on the ARM-911A. Simply insert a SIM card into the modules (not included compatible with any operator).

ARM-911A: automatic digital messages player**LM-911A - LM-306: wall remote control plates for ARM-911A messages****DM PPMS 01 - DM PPMS 01 EX: manual triggers**

ARM-911A

ARM-911A

- High fidelity scalable audio for excellent speech intelligibility (MP3, WAV & WMA)
- Timer scheduled playback (can be used for school ring-tones; Evacuation messages; Containment messages; or for automatic message or playlist playback)
- Fault input monitoring and alarm via 5V reverse DC voltage with a line matching resistor at the EOL
- Scheduled playback of any of the 10 recorded messages and other via web-browser uploadable files
- Balanced audio output (variable output with -50dB/600Ω mic level, -10dB line and +4dB selector)
- Optically coupled 10 Contact Closure and RS232 for control and status
- Industrial grade all metal construction, shock and vibration resistant
- Redundant Flash memory, no battery backup required
- 10 message front panel start selections and status
- Source level, HPF and EQ adjust via web-browser
- SD Memory Playback (2GB)
- Non-Volatile SD Card memory (2GB)
- Multi-message(4) sequencing capability
- Crystal clear 24 bit audio quality
- Over 20 Minutes of audio storage capacity
- Up to 20kHz bandwidth
- Fault output monitoring
- Message playback output monitoring
- Web-browser Configuration
- Source Priority setup via web-browser
- Output Level Adjust via web-browser
- Up to 4 Remote paging mics
- Telephone paging trunk input
- Internal program scheduler
- 24VDC Back up
- Rack mount (1U)

**LM-911A**

- This remote plate connected with a simple RJ45 Cat 5/6 cable allows you to trigger the first 4 messages of the ARM-911A
- Connect up to 4 LM-911A or 4 mic consoles to your ARM-911A
- Dimensions (W×H×D): 114 × 70 × 50mm
- Weight: 123g

**LM-306**

- This remote plate connected with a simple RJ45 Cat 5/6 cable allows you to trigger the first 6 messages of the ARM-911A
- RGB color, tactile feedback, backlit, removable, labelable and customizable buttons
- Dimensions (W×H×D) : 80 × 80 × 47mm
- Weight: 100g



DM PPMS 01
1-button black manual trigger



DM PPMS 01 EX
1-button black manual trigger for outdoor use

RM-911D: table Mic station to trigger the ARM-911A**RM-911W: wall Mic station to trigger the ARM-911A****RM-911D**

- The RM-911D is a remote microphone station featuring a ten-key keypad for message playback selection. Key selection allows activation of pre-recorded message.
- The unit features a unidirectional dynamic microphone with a 14" gooseneck extension.
- An audio signal level meter is provided for displaying the signal levels at the input or output. The unit displays the ready / busy state status via a LED display.
- It can be remote powered from the ARM-911A for a distance up to 300 meters. It requires to be locally powered by an optional 24VDC when installed distance above 300m.
- Talk button can be push to talk or latch on / latch off depending on dip switch setting. A pre-announce and post announce chime is also available with a built-in 1W monitor speaker.
- Easy cat5e wiring (power, audio, communications)
- Broadcast Microphone primary supply
- Microphone Level LED output
- Selectable pre announce chime
- Status display
- 10 message start selections and status
- External Power available (24VDC Adapter)



RM-911D

RM-911W

- The RM-911W is a surface wall-mounted remote microphone station featuring a ten-key keypad for message playback selection. Key selection allows activation of pre-recorded message.
- The unit features a unidirectional dynamic tear-drop, push-to-talk hand held microphone with a retractable coil type cable extension.
- An audio signal level meter is provided for displaying the signal levels at the input or output. The unit displays the ready / busy state status via a LED display.
- It can be remote powered from the ARM-911A for a distance up to 300m. It requires to be locally powered by an optional 24VDC when installed distance above 300m.
- Easy cat5e wiring (power, audio, communications)
- Broadcast Microphone primary supply
- Microphone Level LED output
- In Use Status display
- 10 message start selections and status
- Up to 4 Remote paging mics can be connected to one ARM-911A
- External Power available (24VDC Adapter)



RM-911W



ALIM 24VDC 1.25A
220V/24VDC - 1.25A - 30W power supply

- Constant voltage switching power supply that, when connected to a socket with a 3-point IEC cable, provides constant 24V voltage for a maximum power of 30W.

SMS-112: GPRS or 4G/LTE modem, WiFi, 6 inputs/4 outputs dry contact

SMS/Mail sending box on Alert and Alarm triggering...

- 6 digital inputs (dry contact)
- 4 Analog inputs, 4/20mA, 0/10V, NTC
- 4 dry contact relay outputs
- 12-24VDC or 230VAC power supply
- Integrated backup battery (1 hour max)
- Web server embedded on 32GB SD card
- Up to 300 rules can be triggered (one trigger + 5 conditions + 5 actions)
- Up to 100 predefined users
- Requires MICRO SIM card (3FF) for SMS



Dim. (WxHxD) : 71 x 90 x 58mm

SENDING OF FAULT ALARMS



Sending an alarm by SMS, Mail or Voicemail in the event of an electrical dry contact tripping when the threshold of an analog input is exceeded or if the power supply is cut.

REMOTE COPYING OF A CONTACT



Point-to-point application between 2 SMS-112 transmitters (+ SIM cards). When a contact state changes on SMS-112 #1, it sends a command to SMS-112 #2 to close one of its outputs.

ACCESSORIES



CONFIGURATION



There are many possibilities for implementing the SMS-112:

- LOCAL**
 - > WiFi using an internet browser
 - > Wired via a Serial/USB cable and software
- REMOTE**
 - > Web administration portal (using a browser)
 - > Otherwise by Mail, SMS or Chat TELEGRAM

For sending SMS or for Internet access without a WiFi network, it is necessary to insert a MICRO SIM card (3FF) on the back of the device.

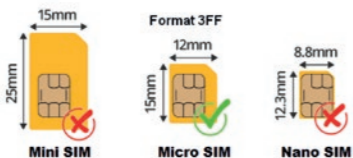

SMS-911: SMS 3G/4G module

- A simple GPI (8 available) triggered will send you an SMS text to alert you. The SMS text content can be customized up to 3 phone numbers using the PC programming software. For each dry contact (among the 8) corresponds the sending of a customizable SMS.
- Has 2 relay outputs, 7A @ 125VAC, 5A @ 125VAC, 20A @ 14VDC.
- The output relay of the alarm link can be activated 0-120 min if the control unit is triggered; 8 Alarm, NC or NO inputs.
- Can be used from anywhere, no distance limitation.
- Quad band GSM GPRS 850/900/1800/1900MHz modules inside; UMTS / HSDPA / 4G / 3G modules are optional.
- 32-bit microcontroller, reliable performance with integrated watchdog.
- 1 siren output can connect to a siren directly.
- 3 SMS alert numbers and 5 alarm numbers.
- Can be configured and programmed from PC Configurator via USB cable.
- Built-in rechargeable battery, energy loss / recovery alarm, 24/24 and 7/7 operation.
- Update firmware via USB.
- Wall mounting or 35mm standard DIN rail, very simple installation.



Connecting the SMS-911 to the ARM-911A



PA example: education buildings, 2 sites

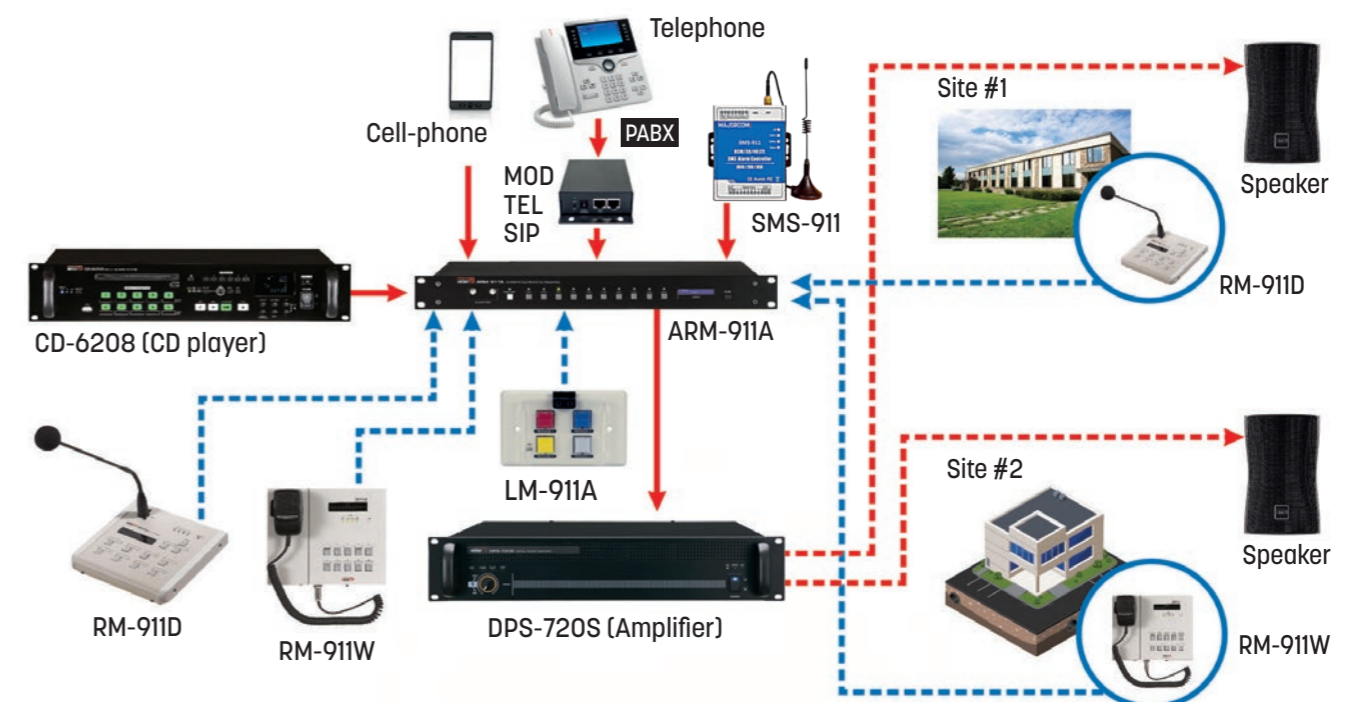

Modele		ARM-911A			
Contact Outputs		5 Dry Contact Outputs			
Power Source		120VAC - 240VAC, 50/60Hz / 24VDC			
Power Consumption		16W			
Operating Temperature		0°C ~ +40°C			
Dimensions		482 x 44 x 280mm · 1U			
Weight		3.5kg			
		Input Sensitivity	Signal to Noise Ratio (S/N, 20kHz LPF, A-WTD)	THD (20kHz LPF)	Bandwidth (+1/-3dB)
AUX 1/2 (CH IN @1kHz)	-50dBu	-50dBu/10kΩ ±3dB	Normal: 67dB, Limit: 60dB	Normal: 0.06%, Limit: 0.15%	20 to 20,000Hz
	-10dBu	-10dBu/10kΩ ±3dB	Normal: 85dB, Limit: 78dB	Normal: 0.007%, Limit: 0.02%	
	+4dBu	+4dBu/10kΩ ±3dB	Normal: 88dB, Limit: 80dB	Normal: 0.005%, Limit: 0.015%	
	+10dBu		Normal: 102dB, Limit: 95dB		
SD CARD (Play MP3, OdBFS 1kHz File)		-10dBu ±3dB	Normal: 94dB, Limit: 87dB	Normal: 0.01%, Limit: 0.04%	20 to 18,000Hz
RM IN (@1kHz), (RM-911D connected)		0dBu/10kΩ ±3dB	Normal: 65dB, Limit: 60dB	Normal: 0.3%, Limit: 0.7%	150 to 18,000Hz
TEL IN (TEL IN @1kHz)		-10dBu/10kΩ	Normal: 85dB, Limit: 78dB	Normal: 0.007%, Limit: 0.02%	100 to 18,000Hz
NETWORK IN (Play MP3, OdBFS 1kHz File @1kHz)		-10dBu/10kΩ	Normal: 85dB, Limit: 78dB	Normal: 0.01%, Limit: 0.04%	20 to 18,000Hz

Model	RM-911D	RM-911W
MIC INPUT (1kHz)	Balanced	Unbalanced
Input Sensitivity	-50dBu ±3dB	
Signal to Noise Ratio (S/N, 20kHz LPF, A-WTD)	Normal: 65dB / Limit: 60dB	Normal: 63dB / Limit: 58dB
THD (20kHz LPF)	Normal: 0.3%, Limit: 0.7%	
Frequency Response (+1/-3dB)	150 to 18,000Hz	
Monitor Amp	0.5W 16Ω	
Maximum Operable Distance CAT5E (50°C)	Cable resistance ≤ 30Ω: 300m / Cable resistance ≤ 80Ω: 100m	
Operating Temperature	-10°C ~ 40°C	
Power Source	24VDC (From ARM-911A)	
Power Consumption (From ARM-911A DC 24V)	4.8W	2W
Dimensions (WxHxD)	200 x 67 x 206mm	261 x 188 x 46mm
Weight	1.37kg	1.7kg

Model	SMS-911
Power Supply	AC adapter: DC 12V / 1A or a DC power supply between 9-36V DC
Power Consumption	Standby: 12VDC / 70 mA ; Max operation: 12VDC / 300 mA
GSM/3G/4G Frequencies	2G: 850/900/1800/1900MHz 3G version Optional: (UMTS/HSDPA) W:900/2100@UMTS 900/1800@GSM; C:850/1900@UMTS 850/900/1800/1900@GSM; T:850/2100@UMTS 850/900/1800/1900@GSM; 4G LTE
SIM card	SIM card only
External Antenna	SMA antenna, 50Ω
Serial Interface	1 USB port
Input Contact	8x NC or NO dry contact
Relay Output	2x Relay Outputs 7A @ 125VAC, 5A @ 125VAC, 20A @ 14VDC
Siren Output	1
Backup Battery	3.7V 900mAH
Dimensions	70 x 88 x 30mm
Installation	35mm standard DIN rail (not supplied) - Wall bracket (default)
Weight	500g

The 6000 System has become the leading digital PA broadcast system

- The 6000 System is available in two editions: the 8-BUS 6800 System and the 1-BUS 6100 System.
- This digital sound system is based on architecture that guarantees reliable performance and high quality, using the latest in microprocessor and digital signal processing (DSP) technology. It is efficient and easy to configure and use thanks to a simple Windows® user interface.
- The system is suited for large areas such as office buildings, educational institutions, hospitals, shopping centres, cam-

pus, transportation centres, penal institutions, and many commercial establishments and businesses.

- Its extendability and flexibility make it an ideal solution for playing voice communications and background music and managing scheduled programs. It provides reliable, efficient communication, with sound adaptable for each zone and excellent speech intelligibility. The system is already being used in many commercial and business applications.

Strengths of the 6000 System

-  **REMOTE** The system is controlled and monitored in real time from a PC (configuration, monitoring, and surveillance of failures).
-  **x32** Up to 32 mic stations with zone group programming.
-  **Macro** Messages and announcements can be triggered on a programmed scheduled and by contact.
-  **Fire Time** Emergency messages and events can be triggered by contact.
-  **Master multiple sources on 8 digital BUSES.**
-  **REMOTE** Control music players (CD player, tuner, etc.) via the RS-232.
-  **BGM** Internal playlist and broadcast scheduling by time slot.
-  **16 to 160 zones possible.**

The heart of the 6800 System: PX-6216 Matrix

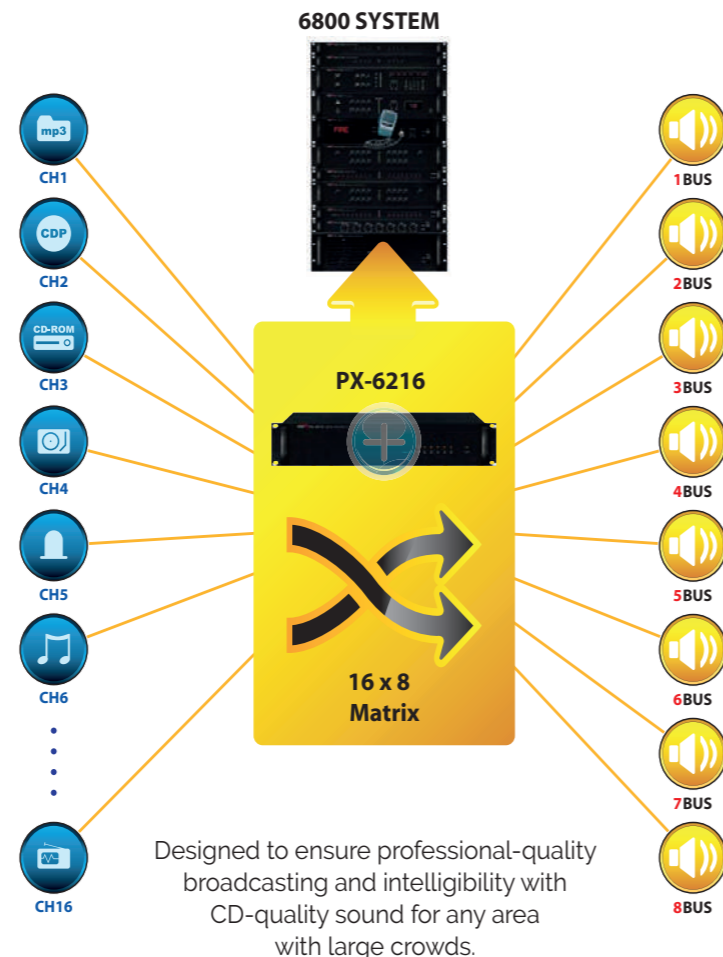

Large expansion capacity

- The digital 6000 System can be extended from 16 to 160 output zones. Oversee up to 10 analog input sources and up to 32 remote RM-6800 mic stations.
- Ideal for anything from simple applications to complex multi-zone applications and background music. Its 8-BUS system lets you move the 8 outputs to any other system interface up to 1km away.

Control software easy to use

- The 6000 System is easy to configure, control, and manage thanks to intuitive, Windows®-based software.
- It comes with enough features to satisfy even the most demanding sound professional, yet is still easy for beginning users to operate. The system management software can also monitor and record system errors.
- The features available in the MS-6800 and MS-6100 software for the 6800 and 6100 Systems include a computer-controlled messaging system, recording management, a scheduling feature, an external graphic programming interface, scheduled emergency announcements, and a multi-zone and per-zone call function. The MS-6800 software comes with the PX-6216, and the MS-6100 comes with the ECS-6216P.
- The MS-6800 can also manage system analyses (including errors), automatic saves, automatic switching to backup amplifiers, and recordings.
- You can connect the PX-6216 to up to 32 RM-6800 mic stations. The stations' keys are configurable using the software, and you can create call groups using the macro feature.

MS-6100/6800

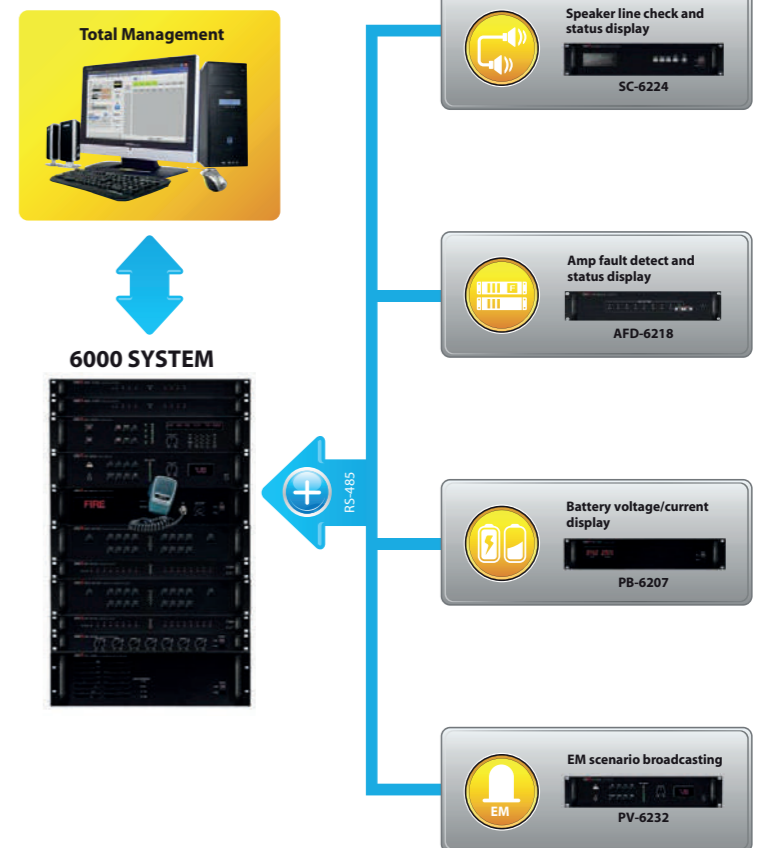

MS-6100 Software

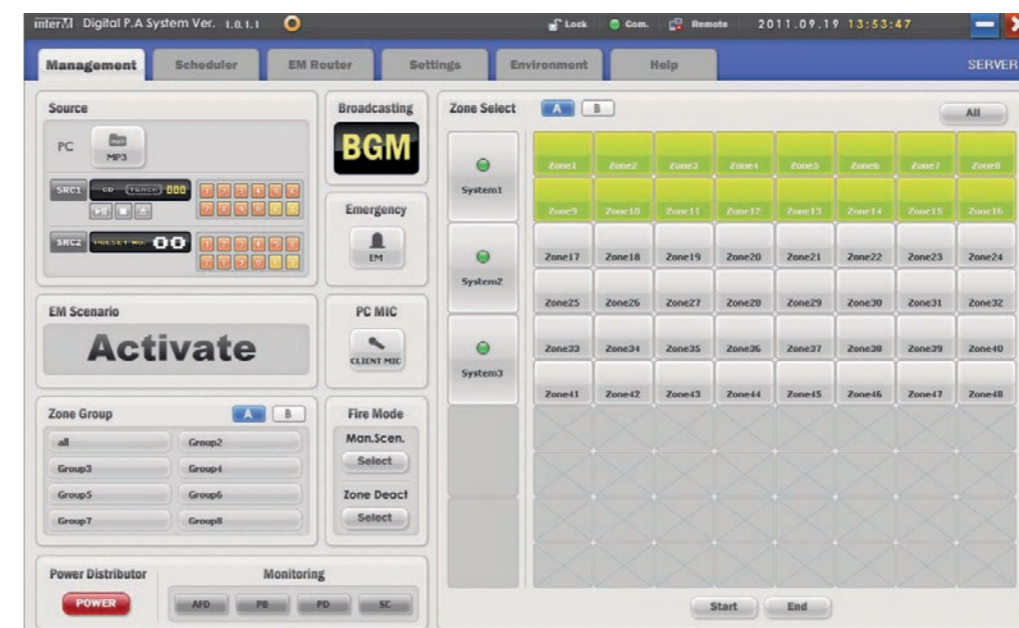

Schedule



EM Router



System setup

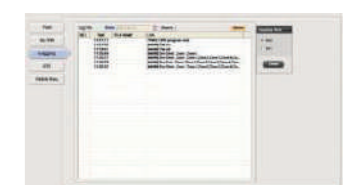

Circumstance setup

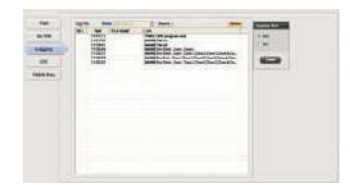

Circumstance setup

MS-6800 Software

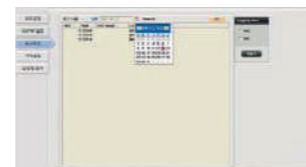

EM Router

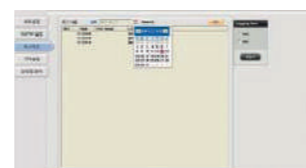

System setup

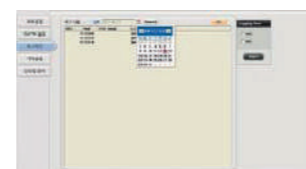

Circumstance setup



Schedule



Preset setup

Digital messaging and play-back music

- Multiple background music inputs that can be operated using the 6000 System management software. Play announcements and planned messages, a built-in playlist, or digital music programmed directly using a PC and management software. With the built-in digital audio recording feature, you can send voice messages or safety announcements automatically. The system also lets you trigger emergency messages and events remotely using input from the external graphic programming interface.
- The 6000 System lets you control various sources, such as the CD-6208, to operate and program CD tracks and audio files stored internally on DRP memory.
- When combined with the SC-6224, you can monitor loud-speaker lines for short circuits, open circuits, overloads, grounding, etc. When combined with the AFD-6214, you can manage amplifiers and switch to a backup amp if an amp fails.
- The MS-6800 and MS-6100 software let you manage equipment status and failure in real time.

System features

- Up to 160 local broadcasts
- Up to 32 remote-controllable microphone stations
- 8 simultaneous broadcasts BUSs
- Handles up to 32 broadcast groups
- 12 pre-selected broadcast keys
- Emergency message broadcast
- Alarm broadcasts, staggered broadcasts, and scheduled programming
- Real-time remote control via PC (monitoring, operation, event logging)
- Program works on network, up to five clients
- User access through four-step password
- System logbook file
- Automatic recording using mic station
- Manage broadcast calendar while on vacation
- Monitor failure of system to communicate with fire alarm systems
- Manage source programs and priority, remote control (MP3, CD, tuner, etc.)
- Broadcast messages by microphone from client PC
- Background music/scheduled messages can be broadcast by PC sound card
- Manage background music broadcast priorities
- Monitoring and equipment control features (power supply, battery charger, loudspeaker, line amplifiers)
- Broadcast messages by telephone
- DSP with built-in 7-band equalizer
- Connects to the system easily with a standard CAT5 cable and RJ45 connector

Educational institutions

Schools, Universities and Colleges, Training facilities

- Educational institutions often need to make scheduled broadcasts and send messages instantly to specific zones over long distances, for instance across a building or campus.
- The 6000 System's built-in digital audio system lets you make customized, scheduled calls to classrooms.
- With its high-quality audio system, it can also broadcast on-demand audio streams to classrooms or specific zones, or even to conference rooms and auditoriums.
- The sound source can be transmitted digitally in very high quality over long distances using a TCP/IP network or fibre optics up to 15km without using repeaters.

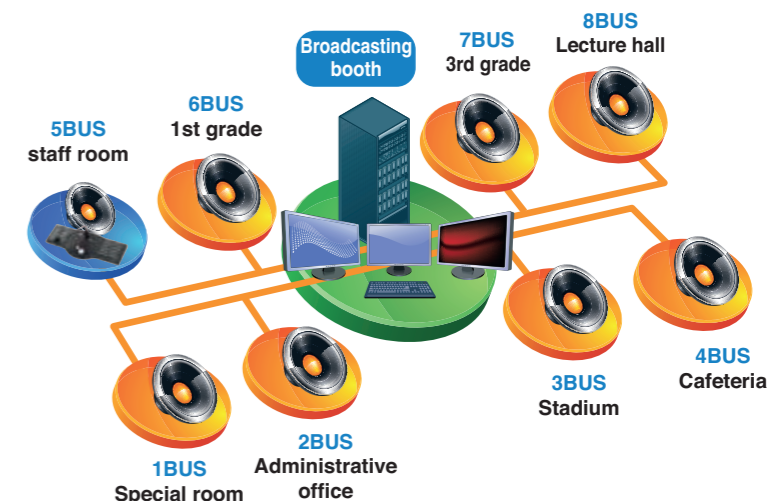

Commercial establishments

Large stores, Shopping centres, Multiplex theatres, Large hotels

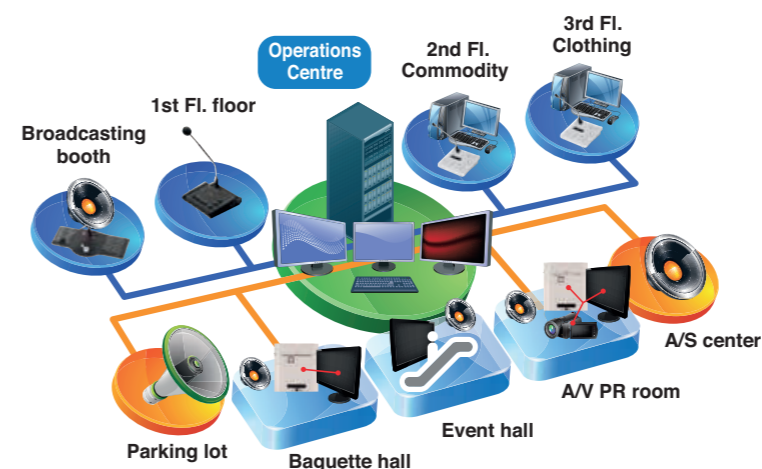

- Commercial establishments require various types of background music coming from local sources and specific announcements that vary according to zone. These constraints can differ for each floor and in each zone.
- The 6000 System is the optimal network system, featuring flexible control and broadcasting from various locations, such as the command centre, the information centre, or service centres.

Public spaces

Office buildings, Train stations, Airports, Hospitals, Exhibition centres

- In public spaces, desired features and sound constraints can vary from one zone or floor to another, depending on the characteristics of the building or area. Some zones may require soft background music, while others may need frequent announcements, whether scheduled or live.
- The 6000 System has a flexible broadcasting and sound source feature, which lets you control the sound source for the entire network, making it the ideal system for use over networks.

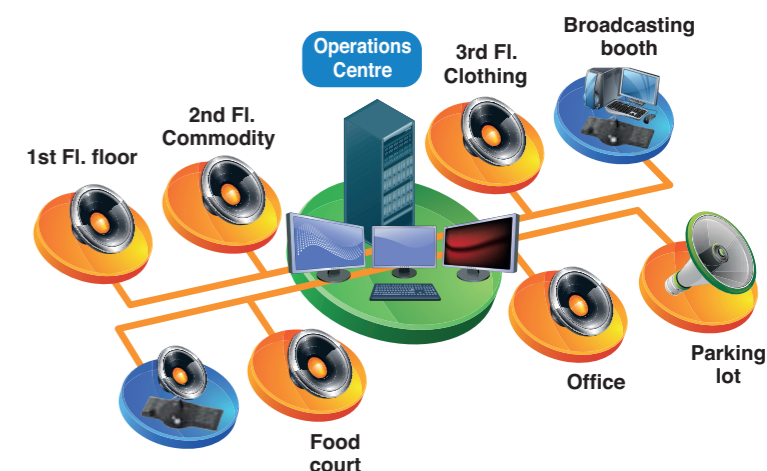

6800 System: multi-zone broadcasting (8 bus)

- The 6800 is a multi-zone broadcasting system programmable directly using a PC and a USB interface. Its 8-BUS system lets you move the 8 outputs to any other system interface up to 1km away.
- Ideal for large, multi-zone broadcasting areas such as office buildings, schools, hospitals, transportation centres, penal institutions, and a variety of commercial and businesses establishments.

- Offering flexible, upgradable voice communications, the 6800 System lets you manage 8 broadcast zones and up to 160 call areas.
- Talk-over priority can be define from control software allowing this system to adapt to all Public Address uses.



- 1** Exhibition hall: 4 lines
- 2** Hall
- 3** Square: 2 lines
- 4** Parking
- 5** **6** Lounge rooms 1 & 2
- 7** Hall 1st floor
- 8** Hall 2nd floor
- 9** Open space
- 10** Storage room
- 11** **12** Conference rooms 1 & 2
- 13 to 15** Meeting rooms 1-2-3
- 16 to 23** Offices 1 to 8
- 24** **25** Information rooms 1 & 2

Batteries

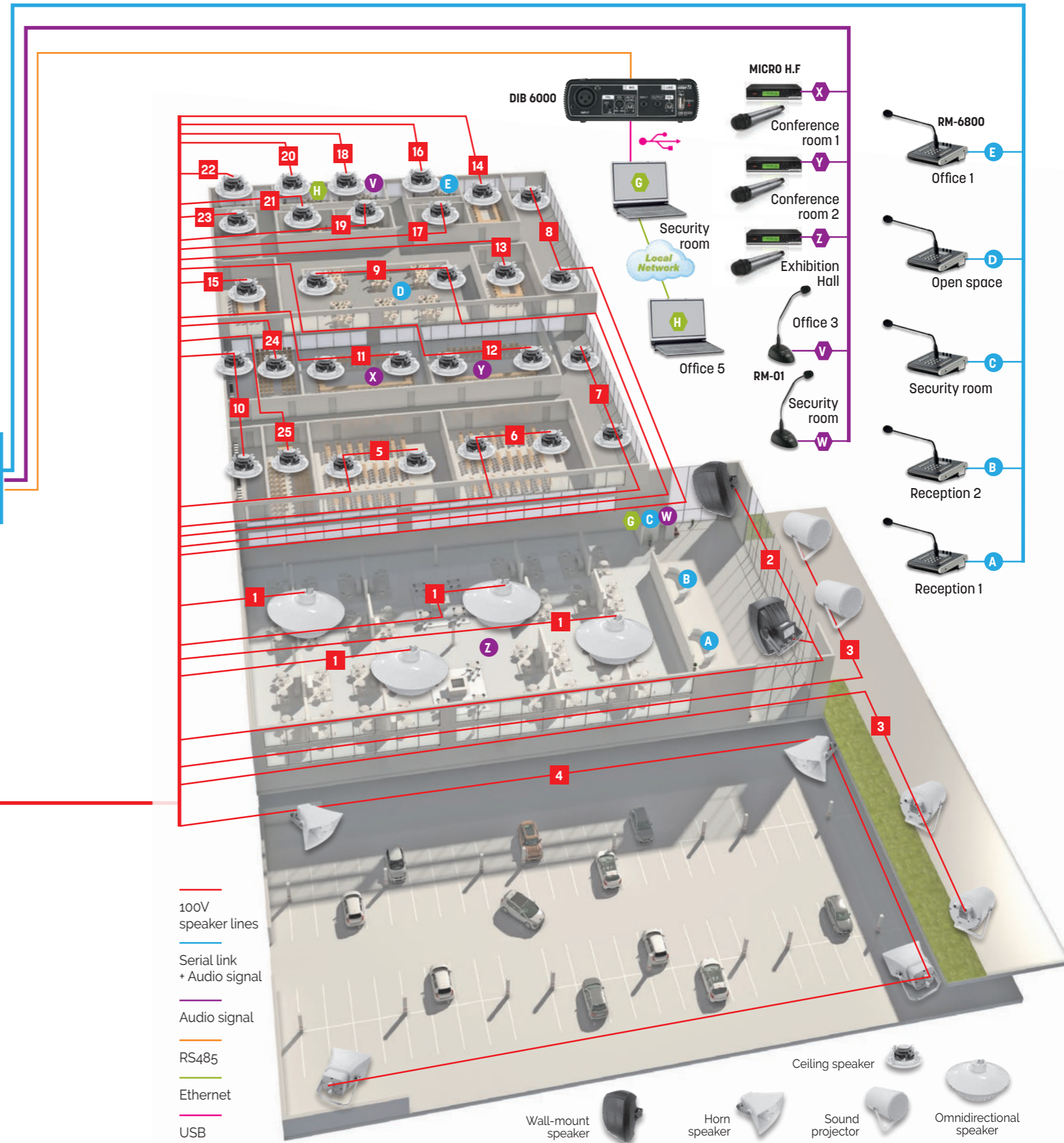

PX-6216: 16 x 8 matrix

- The heart of the 6800 System
- 10 Mic/Line inputs, 2 stereo inputs, 8 outputs
- Connects to 4 selective call microphone stations
- Each input can be processed, monitored, and assigned directly to an output using a PC and a USB interface
- Lets you operate up to 4 audio sources per RS-232 port

DIB-6000: PC USB interface

- Allows a Windows® PC to communicate with the 6800 System
- This means the system can be fully operated and monitored up to 1km away
- Features a source input and an adjustable-level mic that can be given priority

PM-9208: speaker line monitor

- Its high fidelity loudspeaker allows you to listen to up to 8 loudspeaker lines.
- LEDs allow you to visually monitor each speaker line.

AFD-6218: amps control unit

- Lets you switch to a backup amp
- Control up to 8 amps simultaneously
- Front-panel LEDs let you monitor amp status directly

ECS-6216MS: 16-zone extension

- Lets you add 16 zones using a single CAT5 cable connection
- Move the extension up to 1km away using the connection and the 8-BUS system
- Connect up to 9 ECS-6216MS to the system for a total of 160 zones

RME-6108: Mic station extension

- Lets you add 8 RM-6800 selective call mic stations
- 4 RME-6108 can be used for a total of up to 32 stations

SC-6224: loudspeaker line control

- Test up to 24 loudspeaker lines automatically at a configurable, regular interval
- Line failures (open circuit, short circuit, overloads, etc.) are signaled by front-panel LEDs and an audible signal

CD-6208: multi-sources 6 CDs & USB player

- Internal SD memory
- Plays WAV, MP3, and WMA audio files
- Stores up to 6 CDs
- Stereo output (XLR and RCA), mono (XLR), coaxial and optical

PB-6207: 24VDC battery charger

- A display lets you control the voltage and current for charging batteries.

DPA-150Q: Class-D digital amp 4x150W**DPS-240D: Class-D digital amp 2x240W**

- DPA & DPS digital amps with efficiency better than 90% for less heat dissipation, noise, and weight compared to traditional analog amps
- Includes 2 audio inputs, including one priority input to cut the current program so you can broadcast a priority message by dry contact, for example
- The ON/OFF switch can be controlled remotely using a dry contact

**RM-6800 :
Selective call system
mic station**

- Up to 160 zones or zone groups, plus general calls and chime generation
- Up to 1 km away from the system with a single CAT5/6 cable, thanks to RS-422 / CAN BUS communication
- Volume control : MIC / auxiliary input / monitoring speaker / chime

**ALIM 24VDC 1.25A:
220V/24VDC -1.25A - 30W power supply**

PX-6216: 14x8 digital audio matrix up to 32 mic stations



- This DSP-based 14 x 8 digital audio matrix is configured, controlled and monitored by a PC via the MS-6800 custom system control software.
- The PX-6216 is designed to provide professional quality sound and intelligibility with the high performance required for mass notification.
- This matrix offers up to 8 priority levels per fade output (via its modulation detection system).
- MIC/LINE inputs with 7-band EQ, input/output volume control and mixing.
- 6 presets and control (Preset).
- CD-6208 / TU-6200 / ARM-g11A type external source control...
- 8 balanced audio outputs
- High S/N ratio
- Good dynamic range without compression
- The system offers a cost-effective solution for background broadcasting and mic calls.
- Supports full two-channel stereo sound
- 4 RJ45 ports for multi-zone call microphone expandable up to 32 via the RME-6108
- 8 mic/line inputs (2 with phantom power)
- 2 unbalanced line inputs

Model	PX-6216
Output	0dBV balanced
Inputs	EM, TIMER, RM: -10dB balanced / LINE 1-8: -10dB balanced MIC 1-8: -50dB balanced / LINE 9, 10: -10dB unbalanced
Bandwidth ±3dB	20 to 20,000Hz
THD	LINE < 0,01% / MIC < 0,1%
Signal/Noise	LINE > 85dB / MIC > 60 B
Max Signal/Noise	> 100dB (+8dBV input)
Phantom power source	1, 2 : 24VDC
Priority	RM1 > RM2 > RM3 > RM4 > BGM
Communication	LINK IN/OUT: RS-485 (Max. 1km) / RM: RS-422 (Max. 1km) / Source: RS-422 (Max. 12m)
Operating temperature	-10°C ~ 40°C
Power source	24VDC, 1A
Dimensions (WxHxD)	482 x 88 x 280mm · 2U
Weight	4.3kg



Rear panel

ECS-6216MS : 16-zone extension



- Lets you add up to 16 zones using a single CAT5 cable connection. Move the extension up to 1km away using the connection and the 8-BUS system.
- Up to 9 ECS-6216MSs can be connected to the 6800 System for a total of 160 zones.

Model	ECS-6216MS	
Zones	16	
Communication	Link In/Out	RS-485 (Max. 1km)
	Source	RS-232 (Max. 12m)
Operating temperature	-10°C ~ 40°C	
Power source	24VDC, 600mA	
Dimensions (WxHxD)	482 x 88 x 280mm · 2U	
Weight	4.3kg	

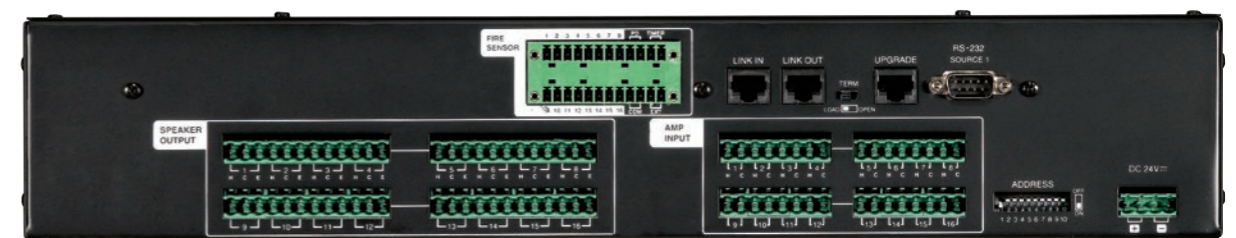

Rear panel

DIB-6000: PC USB interface



- The USB interface allows a Windows® PC to communicate with the 6800 System. It converts the PC's USB output into RS-485.
- This means the system can be entirely operated and monitored at distances up to 1km.

- The DIB-6000 features a source input and an adjustable-level mic input that can be given priority. The Mic input can be used to record announcements on the PC.

Model	DIB-6000
Interface	USB
Communication	RS-485 (Max. 1km)
Operating temperature	-10°C ~ 40°C
Power source	USB 5VDC
Dimensions (LxPxH)	140 x 43 x 140mm
Weight	0.74kg
MIC IN balanced to LINE OUT balanced	
Sensitivity	-60dB
THD	< 0.5%
Bandwidth	70 to 10,000Hz
Signal / Noise	> 50dB
LINE IN unbalanced to LINE OUT balanced	
Sensitivity	+1.4dB
THD	< 0.2%
Bandwidth	40 to 20,000Hz
Signal / Noise	> 80dB
LINE IN balanced to LINE OUT unbalanced	
Sensitivity	+1.4dB
THD	< 0.2%
Bandwidth	40 to 20,000Hz
Signal / Noise	> 80dB

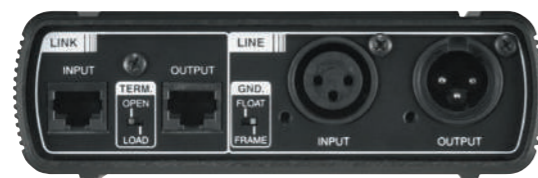

Rear panel

RME-6108: mic station extension

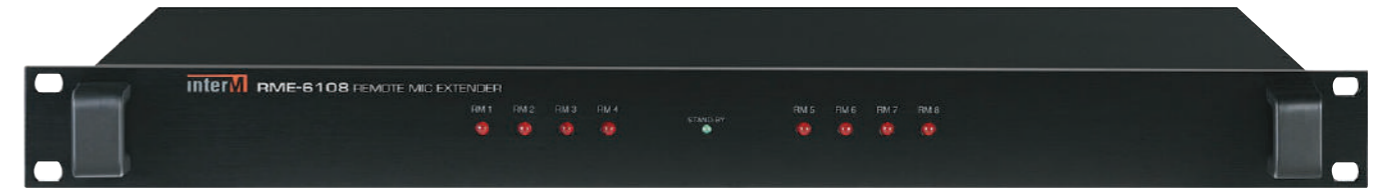

- Lets you add 8 RM-6800 selective call mic stations.
- 4 RME-6108 can be used for a total of up to 32 stations in the 6800 System.
- Manage station priorities using the system management software.

Model	RME-6108
Channels	8
Communication	RS-422 (Max. 1km)
Operating temperature	-10°C ~ 40°C
Power source	24VDC
Dimensions (WxHxD)	482 x 44 x 280mm · 1U
Weight	2.8kg



Rear panel

RM-6808: system Mic station

- Multi-system selective call mic station
- Up to 160 zones or zone groups, plus general calls and chime generation
- Up to 1 km away from the system with a single CAT5/6 cable, thanks to RS-422 / CAN BUS communication
- Zone group configuration for the 6800/6100 system is carried out directly with the MS-6800 system management software.
- 0 ~ 9 Keys, All, Talk, Chime buttons
- 2.43" OLED display
- Output level indicator
- Monitoring speaker
- Volume control : MIC / auxiliary input / monitoring speaker / chime
- Balanced 0dB audio output and 16 dry-contact remote controls for RM-g16/RM-616 mode
- DC 24V power input



RM-6800



RM-6800 Rear panel

PM-9208: speaker line monitor, 8 zones

- It provides audible and visual monitoring of up to 8 single-channel amplifiers or speaker lines.
- 8 x 8-segment LED displays monitor up to 8 amplifier outputs or speaker lines, with 5-step attenuation to match different amplifier levels.
- A built-in speaker allows monitoring of the selected channel and features 4-step attenuation. The speaker is passive (no internal amplifier) and the LED display requires 24VDC (power supply not included).
- 8-Channel Monitor Panel
- 10 Segments LED Meter for Each Channel
- Built-In Monitor Speaker
- Channel Selector Switches
- LED Indication on Each Switch
- Monitors 8 70/100V Lines
- 24VDC Operation Only
- Rack Mount (2U)
- Power Supply Not Included

Model	PM-9208
Inputs	8 x 100V / 70V
LED display	8 outputs (simultaneous)
Attenuator	5 positions
Output power	Max 1.5W
Frequency response	32 to 16,000
Operating temperature	-10°C - 40°C
Power source	24VDC
Dimensions (WxHxD)	482 x 88 x 280mm · 2U
Weight	3.8kg



Rear panel

SC-6224: loudspeaker line control

- Test up to 24 loudspeaker lines automatically at a configurable, regular interval.
- Line failures (open circuit, short circuit, overloads, etc.) are signaled by front-panel LEDs and an audible signal.

Model	SC-6224
Line impedance test	20Ω - 3kΩ
Test duration / channel	< 100ms
Test interval	5-200min
Channels	24
Operating temperature	-10°C ~ 40°C
Power source	24VDC, 200mA
Dimensions (WxHxD)	482 x 88 x 280mm · 2U
Weight	4.4kg

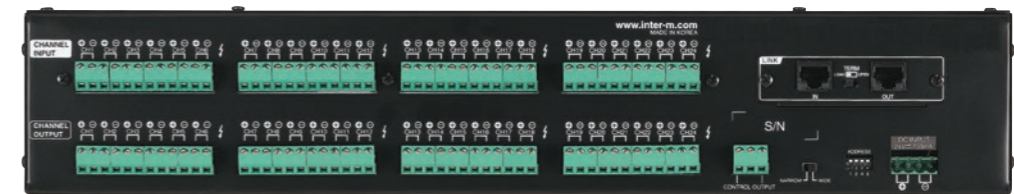

Rear panel

AFD-6218: amps control unit



- Control unit lets you switch to a backup amp.
- Control up to 8 amps simultaneously.
- An adjustable-interval test controls connected amps automatically.
- Front-panel LEDs let you monitor amp status directly.
- Failures can also be viewed in the system software.

Model	AFD-6218
Amp inputs	8 + 1 safety amp
Amp outputs	8 + 1 safety amp
Audio inputs	8
Operating temperature	-10°C ~ 40°C
Power source	24VDC, 170mA
Dimensions (WxHxD)	482 x 88 x 280mm · 2U
Weight	4kg



Rear panel

CD-6208: multi-sources 6 CDs & USB player



- Professional multi-source USB/CD player with internal SD memory.
- Plays WAV, MP3, and WMA audio files.
- High-quality storage of up to 6 CDs. Controls are easily accessible on front panel or through the RS-232 port.
- Features output in stereo (XLR and RCA), mono (XLR), coaxial and optical.
- Device is operable using AMX and CRESTRON systems via an RS-232 port.

Model	CD-6208
Discs and formats	CD / CD-R / CD-RW · Audio CD - MP3 - WMA
Outputs	2 x XLR L/R - 1 XLR mono - RCA - 2 SPDIF (optical, analog)
Bandwidth	20 to 20,000Hz ±0.5dB
T.H.D	< 0.003%
Signal / Noise	> 100dB
Memories	1 to 5 = 1GB ; 6 = 3GB (total 8GB)
Consumption power	27
Power source	230VAC - 50Hz
Dimensions (WxHxD)	482 x 88 x 280mm · 2U
Weight	5.3kg



Rear panel

PB-6207: 24VDC battery charger



- The PB-6207 is a unit for recharging the battery to insure that the battery's maximum charge capacity is achieved.
- **BATTERY AUTO RECHARGING**
It charges with maximum 3A, when it close to full charging (26.4V) the electric current will be reduced up to 10mA-20mA for maintaining a full charging.

- **VOLTAGE/CURRENT DISPLAY**
Front LCD displays status of power distribution (Voltmeter/ Amperemeter).
- **PC MONITORING**
The charging voltage and current can be monitored by window program of 6800 System.

Model	PB-6207
Full charge voltage	26.4V
Starting current	3A Max.
Operating temperature	-10°C ~ 40°C
Power source	230VAC · 50/60Hz
Dimensions (WxHxD)	482 x 88 x 280mm · 2U
Weight	6kg

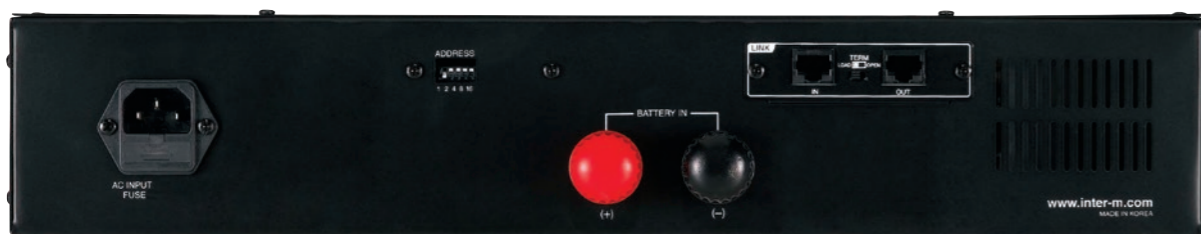

Rear panel

DPA-150Q: Class-D 4x150W - 100V - 24V DC digital amp
DPS-240D: Class-D 2x240W - 100V - 24V DC digital amp



DPA-150Q



DPS-240D

- DPA & DPS are Class-D digital amplifiers with efficiency better than 90% for less heat dissipation, noise, and weight compared to traditional analog amps.
- They include 2 audio inputs, including one priority input to cut the current program so you can broadcast a priority message by dry contact, for example.
- The ON/OFF switch can be controlled remotely using a dry contact.
- Front-panel LEDs let you see amp status instantly.
- These amplifiers are fitted with a 24VDC supply terminal block for use on booster batteries.

Model	DPA-150Q	DPS-240D
RMS Power	4 x 150W	2 x 240W
Bandwidth (1W, ±3dB)	50 to 20,000Hz	60 to 20,000Hz
100V impedance	66.7Ω	41.6Ω
70V impedance	32.7Ω	20.4Ω
Input sensitivity	1V/10kΩ	
THD	<0.2%	< 0.5%
Signal / Noise	>100dB	> 100dB
Operating temperature	-10°C ~ 40°C	
Power source	AC 220 - 240V · 50/60Hz - DC 24V	
Dimensions (WxHxD)	482 x 88 x 367mm · 2U	482 x 88 x 371mm · 2U
Weight	6.8kg	7.4kg



DPA-150Q rear panel



DPS-240D rear panel

ALIM 24VDC 1.25A**220V/24VDC - 1.25A - 30W power supply**

- A constant voltage switching power supply necessary for some devices that require an external power supply.
- Connects directly to a mains using a 3-point IEC cable and provides constant 24V voltage for a maximum power of 30W.

Model	ALIM 24VDC 1.25A
Input	90-260VAC
Output	24VDC
Power	30W
Operating temperature	-10°C ~ 70°C
Dimensions (WxHxD)	93 x 35 x 49mm
Weight	275g

Which 6800 System component requires the ALIM 24VDC 1.25A?

Model	ALIM 24VDC 1.25A
PM-9208	•
RME-6108	•
PX-6216	•
ECS-6216MS	•
AFD-6218	•
SC-6224	•
RM-6800	•

Selective Call System

- Configuration and operation are simple and efficient thanks to a Windows® interface.
- Ideal for large areas with multi-zone broadcasting such as office buildings, schools, hospitals, transportation centres, penal institutions, and a variety of commercial and businesses establishments.
- Offering flexible, upgradable voice communications, the 6100 System can be extended from 16 to 160 call zones.
- 1 source and 16 call stations can be connected to the system. Multiple signals can be transmitted over long distances via the digital BUS using a TCP/IP network or fibre optics up to 15km.

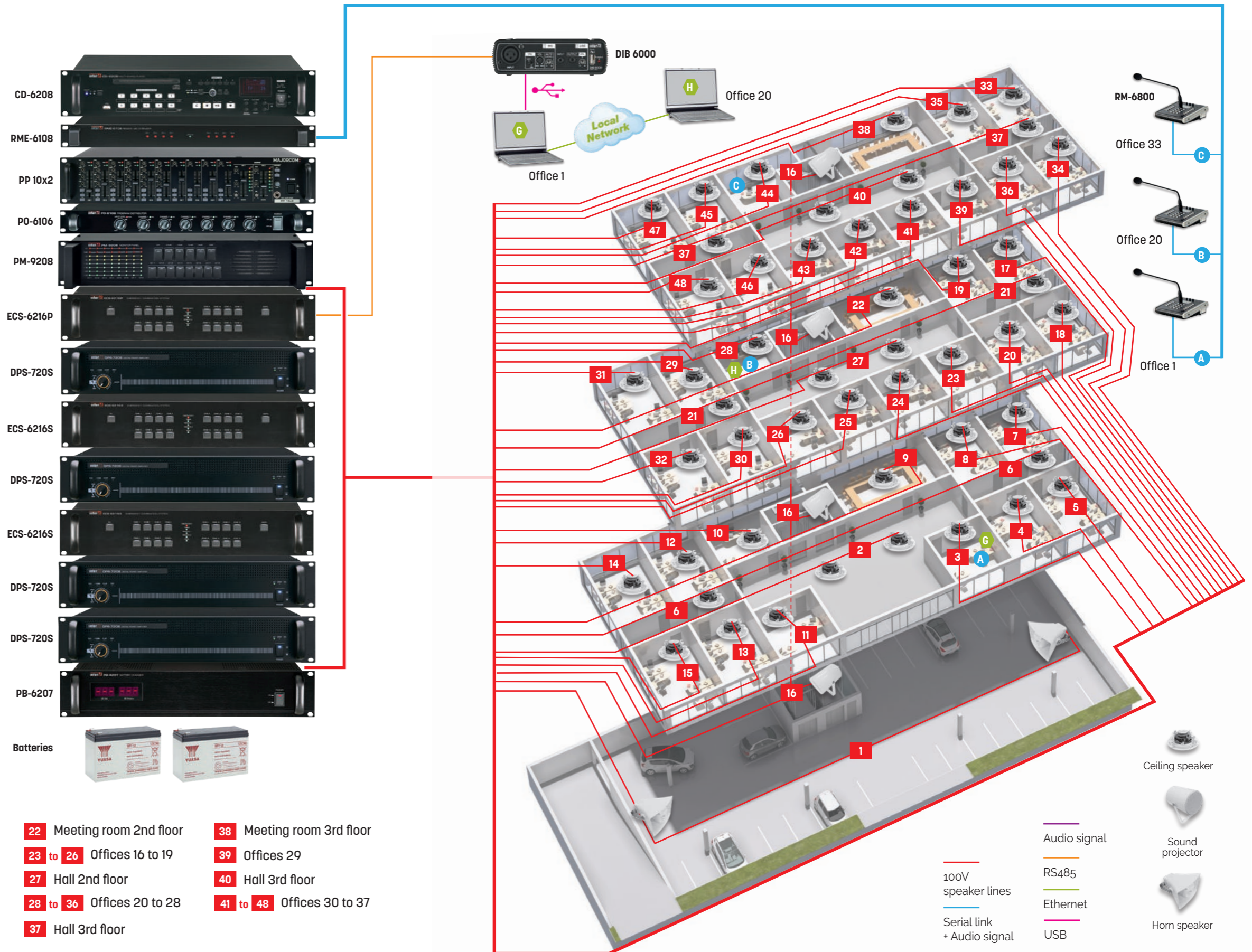

ECS-6216P: main matrix unit

- Provides 16 call zones.
- Communicates with system elements via a CAT5 cable on 1 BUS to make installation easier.
- Uses 2 RS-232 interfaces to operate audio sources such as a CD player or tuner.

PM-9208: speaker line monitor

- Its high fidelity loudspeaker allows you to listen to up to 8 loudspeaker lines.
- LEDs allow you to visually monitor each speaker line.

PP 10x2 : 10 inputs/2 outputs preamplifier-mixer

- Rack-mounting preamplifier fitted with 10 inputs and 2 outputs. Each input has a display of modulation presence.
- Trim and tonal setting on each input (except CH7 to CH10).
- 2 outputs with 2-band equalization. A bar graph on each output allows to display the modulation level.

PB-6207: 24VDC battery charger

- A display lets you control the voltage and current for charging batteries.

ECS-6216S: extension module for the ECS-6216P

- Lets you extend the system to up to 160 zones.

DIB-6000: PC USB interface

- Allows a Windows® PC to communicate with the 6800 System
- This means the system can be fully operated and monitored up to 1km away
- Features a source input and an adjustable-level mic that can be given priority

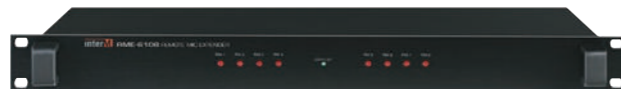
RME-6108: Mic station extension

- Lets you add 8 RM-6800 selective call mic stations
- 4 RME-6108 can be used for a total of up to 32 stations

CD-6208: multi-sources 6 CDs & USB player

- Internal SD memory
- Plays WAV, MP3, and WMA audio files
- Stores up to 6 CDs
- Stereo output (XLR and RCA), mono (XLR), coaxial and optical

DPS-720S: 720W Class-D digital amplifier - 100V - 24VDC

- The DPS-720S is a 2U, single channel, 720W power Class D digital amplifier with over 90% efficiency.
- Thus, it allows the reduction of heat dissipation, noise and weight compared to traditional analog amps.
- This amplifier has 2 audio inputs including a priority input allowing the current program to be cut off for the broadcast of a priority message by dry contact, for example.



RM-6800 :
Selective call system
mic station

- Up to 160 zones or zone groups, plus general calls and chime generation
- Up to 1 km away from the system with a single CAT5/6 cable, thanks to RS-422 / CAN BUS communication
- Volume control : MIC / auxiliary input / monitoring speaker / chime

ALIM 24VDC 1.25A: 220V/24VDC -1.25A - 30W power supply

ECS-6216P: main matrix unit

ECS-6216S: extension module for the ECS-6216P



ECS-6216P

- The ECS-6216P is the main matrix unit for the 6100 System. It provides 16 call zones. A USB interface (DIB 6000) lets you control and configure the system using a PC. Manage up to 160 call zones using the ECS-6216S extensions.
- Connects to 2 selective call mic stations by default. Connect to up to 16 stations using the RME-6108 extensions.

- The ECS-6216P communicates with 6100 System elements through a CAT5 cable on 1 BUS to make installation easier.
- Two RS-232 interfaces operate audio sources such as a CD player, tuner, etc.



ECS-6216S

- The ECS-6216S is the extension module for the ECS-6216P, letting you extend the system by 16 zones.

- Create up to 160 zones by daisy-chaining units.

Model	ECS-6216P	ECS-6216S
Priority	EMERGENCY > TIMER > RM 1 > RM 2 > MAIN	
Zones	16	
Communication	Link In/Out	RS-485 (Max. 1km)
	RM	RS-422 (Max. 1km)
	Source	RS-422 (Max. 12m)
Operating temperature	-10°C ~ 40°C	
Power source	24VDC	
Dimensions (WxHxD)	482 x 88 x 280mm · 2U	
Weight	4.3kg	



ECS-6216P rear panel



ECS-6216S rear panel

DIB-6000: PC USB interface



- The USB interface allows a Windows® PC to communicate with the 6800 System. It converts the PC's USB output into RS-485.
- This means the system can be entirely operated and monitored at distances up to 1km.

- The DIB-6000 features a source input and an adjustable-level mic input that can be given priority. The Mic input can be used to record announcements on the PC.

Model	DIB-6000
Interface	USB
Communication	RS-485 (Max. 1km)
Operating temperature	-10°C ~ 40°C
Power source	USB 5VDC
Dimensions (LxPxH)	140 x 43 x 140mm
Weight	0.74kg
MIC IN balanced to LINE OUT balanced	
Sensitivity	-60dB
THD	< 0.5%
Bandwidth	70 to 10,000Hz
Signal / Noise	> 50dB
LINE IN unbalanced to LINE OUT balanced	
Sensitivity	+1.4dB
THD	< 0.2%
Bandwidth	40 to 20,000Hz
Signal / Noise	> 80dB
LINE IN balanced to LINE OUT unbalanced	
Sensitivity	+1.4dB
THD	< 0.2%
Bandwidth	40 to 20,000Hz
Signal / Noise	> 80dB

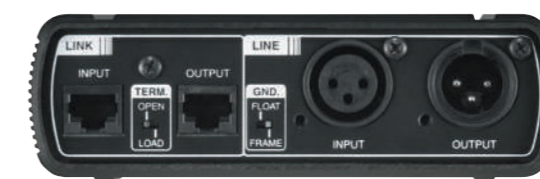

Rear panel

PM-9208: speaker line monitor, 8 zones

- It provides audible and visual monitoring of up to 8 single-channel amplifiers or speaker lines.
- 8 x 8-segment LED displays monitor up to 8 amplifier outputs or speaker lines, with 5-step attenuation to match different amplifier levels.
- A built-in speaker allows monitoring of the selected channel and features 4-step attenuation. The speaker is passive (no internal amplifier) and the LED display requires 24VDC (power supply not included).
- 8-Channel Monitor Panel
- 10 Segments LED Meter for Each Channel
- Built-In Monitor Speaker
- Channel Selector Switches
- LED Indication on Each Switch
- Monitors 8 70/100V Lines
- 24VDC Operation Only
- Rack Mount (2U)
- Power Supply Not Included

Model	PM-9208
Inputs	8 x 100V / 70V
LED display	8 outputs (simultaneous)
Attenuator	5 positions
Output power	Max 1.5W
Frequency response	32 to 16,000
Operating temperature	-10°C - 40°C
Power source	24VDC
Dimensions (WxHxD)	482 x 88 x 280mm · 2U
Weight	3,8kg

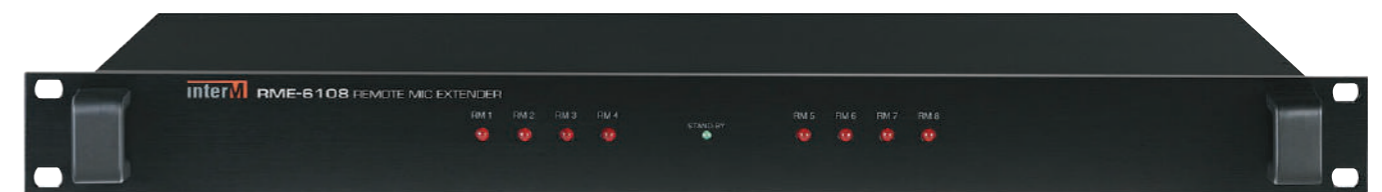

Rear panel

RME-6108: mic station extension

- Lets you add 8 RM-6800 selective call mic stations.
- 4 RME-6108 can be used for a total of up to 32 stations in the 6800 System.
- Manage station priorities using the system management software.

Model	RME-6108
Channels	8
Communication	RS-422 (Max. 1km)
Operating temperature	-10°C ~ 40°C
Power source	24VDC
Dimensions (WxHxD)	482 x 44 x 280mm · 1U
Weight	2,8kg



Rear panel

RM-6808: system Mic station

- Multi-system selective call mic station
- Up to 160 zones or zone groups, plus general calls and chime generation
- Up to 1 km away from the system with a single CAT5/6 cable, thanks to RS-422 / CAN BUS communication
- Zone group configuration for the 6800/6100 system is carried out directly with the MS-6800 system management software.
- 0 ~ 9 Keys, All, Talk, Chime buttons
- 2.43" OLED display
- Output level indicator
- Monitoring speaker
- Volume control : MIC / auxiliary input / monitoring speaker / chime
- Balanced 0dB audio output and 16 dry-contact remote controls for RM-g16/RM-616 mode
- DC 24V power input



RM-6800



RM-6800 Rear panel

PP 10x2: 10 inputs/2 outputs preamplifier-mixer



- Rack-mounting preamplifier fitted with 10 inputs and 2 outputs. Each input has a display of modulation presence.
- 10 inputs correspond to the following:
 - 6 Mic/Line inputs (CH1 to CH6) which 2 priorities and fitted with a Phantom power supply.
 - 4 Line inputs (CH7 to CH10).
 - 1 top priority odB input.
- Trim and tonal setting on each input (except CH7 to CH10).
- 2 outputs with 2-band equalization. A bar graph on each output allows to display the modulation level.
- Record output, needful for many applications.
- Possibility of emergency power supply of 24VDC in case of power failure.

Model	PP 10x2
Bandwidth	20 to 20,000Hz
Input sensitivity	6 Mic/Line input balanced -60/odB 4 unbalanced Line inputs odB 1 top priority input odB 1 record output 2 balanced outputs odB
T.H.D	< 0.2%
Input equalizer	±12dB @ 80Hz, 2.5kHz and 12kHz
Signal / Noise	> 70dB
Power source	230VAC - 50Hz / 24VDC / 16W
Dimensions (WxHxD)	482 x 88 x 320mm · 2U
Weight	5.3kg

CD-6208: multi-sources 6 CDs & USB player



- Professional multi-source USB/CD player with internal SD memory.
- Plays WAV, MP3, and WMA audio files.
- High-quality storage of up to 6 CDs. Controls are easily accessible on front panel or through the RS-232 port.
- Features output in stereo (XLR and RCA), mono (XLR), coaxial and optical.
- Device is operable using AMX and CRESTRON systems via an RS-232 port.

Model	CD-6208
Discs and formats	CD / CD-R / CD-RW · Audio CD - MP3 - WMA
Outputs	2 x XLR L/R - 1 XLR mono - RCA - 2 SPDIF (optical, analog)
Bandwidth	20 to 20,000Hz ±0.5dB
T.H.D	< 0.003%
Signal / Noise	> 100dB
Memories	1 to 5 = 1GB ; 6 = 3GB (total 8GB)
Consumption power	27
Power source	230VAC - 50Hz
Dimensions (WxHxD)	482 x 88 x 280mm · 2U
Weight	5.3kg



Rear panel



Rear panel

PB-6207: 24VDC battery charger

- The PB-6207 is a unit for recharging the battery to insure that the battery's maximum charge capacity is achieved.
- **BATTERY AUTO RECHARGING**
It charges with maximum 3A, when it close to full charging (26.4V) the electric current will be reduced up to 10mA-20mA for maintaining a full charging.

- **VOLTAGE/CURRENT DISPLAY**
Front LCD displays status of power distribution (Voltmeter/ Amperemeter).
- **PC MONITORING**
The charging voltage and current can be monitored by window program of 6800 System.

Model	PB-6207
Full charge voltage	26.4V
Starting current	3A Max.
Operating temperature	-10°C ~ 40°C
Power source	230VAC · 50/60Hz
Dimensions (WxHxD)	482 x 88 x 280mm · 2U
Weight	6kg



Rear panel

DPS-720S: 720W Class-D digital amp - 100V - 24VDC

- The DPS-720S is a 2U, single channel, 720W power Class-D digital amplifier with over 90% efficiency.
- It allows the reduction of heat dissipation, noise and weight compared to traditional analog amps.
- This amp includes 2 audio inputs, including one priority input to cut the current program so you can broadcast a priority message by dry contact, for example.
- Front-panel LEDs let you see amp status instantly.
- Fitted with a 24VDC supply terminal block for use on booster batteries.

Model	DPS-720S
RMS Power	720W
Bandwidth (1W, ±3dB)	60 to 20,000Hz
100V impedance	13.9Ω
70V impedance	10.2Ω
Input sensitivity	1V/10kΩ
THD (AES17, 1/8 Puissance)	< 0.5%
Signal / Noise (20kHz LPF)	> 100dB
Operating temperature	-10°C ~ 40°C
Power source	AC 220 - 240V · 50/60Hz - DC 24V
Consumption	250W
Dimensions (WxHxD)	482 × 88 × 424mm
Weight	7.96kg



Rear panel

ALIM 24VDC 1.25A**220V/24VDC - 1.25A - 30W power supply**

- A constant voltage switching power supply necessary for some devices that require an external power supply.
- Connects directly to a mains using a 3-point IEC cable and provides constant 24V voltage for a maximum power of 30W.

Model	ALIM 24VDC 1.25A
Input	90-260VAC
Output	24VDC
Power	30W
Operating temperature	-10°C ~ 70°C
Dimensions (WxHxD)	93 x 35 x 49mm
Weight	275g

Which 6100 System component requires the ALIM 24VDC 1.25A?

Model	ALIM 24VDC 1.25A
ECS-6216S	•
ECS-6216P	•
RME-6108	•
RM-6800	•
PM-9208	•

MXCW Conference System



Total freedom

- The MXCW conference system offers all the features expected of a conference system for up to 125 participants, with the convenience of encrypted digital HF transmission.
- It eliminates the use of cables for off-site meetings, in rooms where seats are not assigned, as well as in listed buildings where it is not possible to pierce the walls or the furniture.
- Proven interference detection and avoidance technology provides reliable transmission without signal loss, and robust encryption of audio signals ensures confidentiality of meeting content.
- Each HF conference unit is powered by an intelligent lithium-ion rechargeable battery, whose residual charge in hours and minutes can be viewed remotely and in real time.

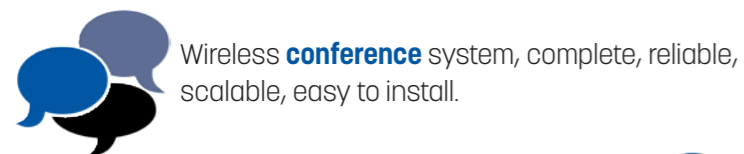

Wireless **conference** system, complete, reliable, scalable, easy to install.

The system natively integrates **voting management** with 2, 3 or 5 buttons, with display of the result on the chairman station and on the Web interface.



The system has **simultaneous translation** mode and can handle up to 8 channels using dedicated equipment.



MXCW Conference System



Worry-free wireless

Innovative interference detection technology avoids wireless issues before they are even noticed.



Quick setup

Last minute meetings are inevitable. The MXCW system deploys quickly and self-configures in minutes.



Works in any room

From flexible meeting spaces to high profile historic venues, MXCW goes anywhere your meetings take you.



Nothing else to bring

With only three core system components, MXCW ensures you always have the right equipment for the next important discussion.



Powerfully scalable

Tackle even the most complex meeting needs with onboard features including voting, agenda management, and interpretation.



Great sound for every participant

A dedicated, high-quality loudspeaker at each unit provides clear, intelligible audio for everyone involved.

MXCW Conference System components

MXCW640: wireless touchscreen conference unit

- Chairman, Delegate, Ambient Mic, Listener and Remote Caller roles
- Dual Delegate role allows two participants to share one conference unit
- 4.3-inch / 110mm capacitive touchscreen display to view meeting controls, speak/request list, voting, etc.
- 2 channel selectors, each with a 3.5mm headphone jack
- Battery life of up to 11 hours

Shown with MXC416-C 16" Gooseneck Microphone

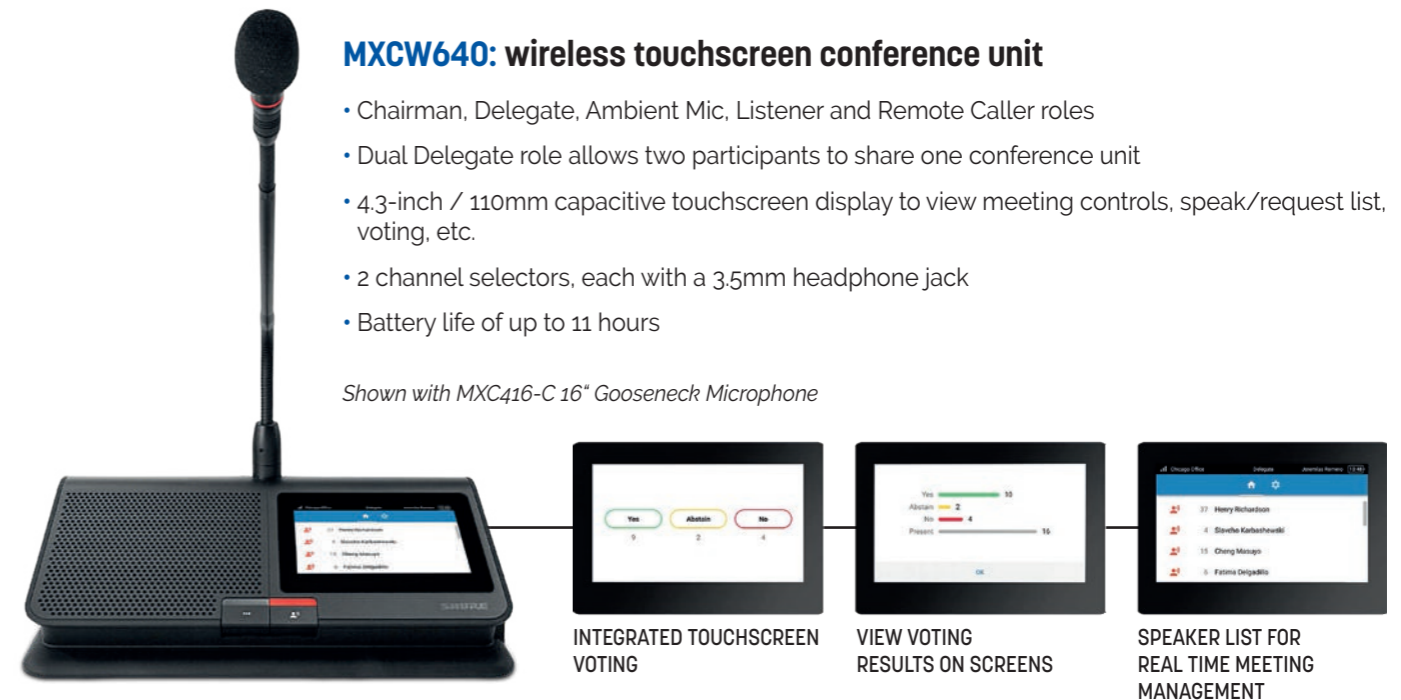

MXCWAPT-W: wireless access point transceiver

- Controls up to 125 wireless conference units
- Automated frequency coordination
- Interference detection & avoidance
- AES-128 wireless encryption
- Dante™ digital networking enables routing of 10 audio channels in/out over Ethernet to any Dante-equipped device



SB930: intelligent rechargeable li-ion battery



- Networked Charging Station for up to 10 SB930 batteries
- Fully charges 10 batteries in 4 hours
- Remotely monitor charge levels in hours and minutes
- Integrated test button and 5-segment LED to display charge level
- Storage mode protects batteries by storing them at a safe charge level that preserves battery health over time

MXCWNCSE: networked charging station

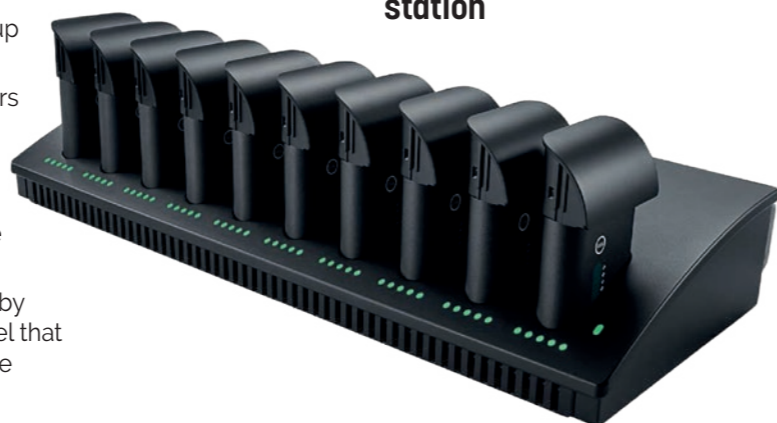

Gooseneck microphones

- Series of Microflex multipin gooseneck microphones for use with MXCW conference units only.
- Built-in CommShield® technology provides improved immunity to RF noise emitted by mobile phones or tablets.
- Available Dualflex gooseneck accommodates shared use or standing speakers
- Choice of 6"/15cm, 16"/40cm, 20"/50cm lengths.
- Built-in bi-color (red/green) LED illuminates when mic is active.
- The standard cardioid directivity ensures precise sound pick-up on the voice, and attenuates the ambient noise of the room. If difficult acoustic conditions require additional directivity control, the mini shotgun capsule is also available.

Monitor and control

MXCW Conference System includes an intuitive and powerful browser-based control interface for management of all system features, including audio levels, RF settings and more.



Adjust audio output levels and route Dante™ audio wherever required. A total of two analog and 10 Dante™ audio channels are available.

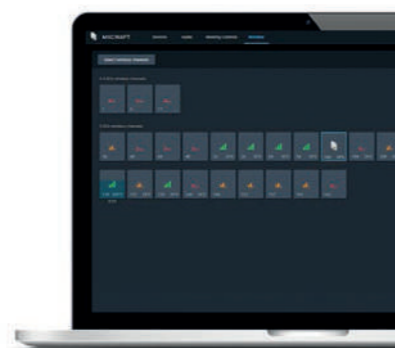

Real time monitoring of wireless system health, channel availability, and frequency management settings give you the confidence for a meeting free of interruptions and lost productivity.

Easy to deploy

- The all-in-one-design of MXCW Conference System means meetings can happen anywhere.
- Automated frequency coordination with interference detection and avoidance, minimizes any complicated set up. This also enables meetings to run more smoothly without a technician present..
- Setting up your next meeting is as simple as **three steps**:



1 MOUNT & POWER UP THE MXCWAPT-W ACCESS POINT



2 INSERT THE SB930 BATTERY INTO EACH DELEGATE UNIT

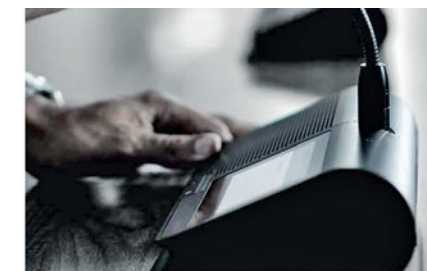

3 DEPLOY & POWER ON DELEGATE UNITS WHERE NEEDED

Tackle any space

Need to outfit a meeting space with audio the day before a big meeting with 50 people? No problem, with MXCW Conference System. Each participant gets his own microphone, loudspeaker, and control, right in front of him. It is the winning solution compared to the complexity of conventional equipment.

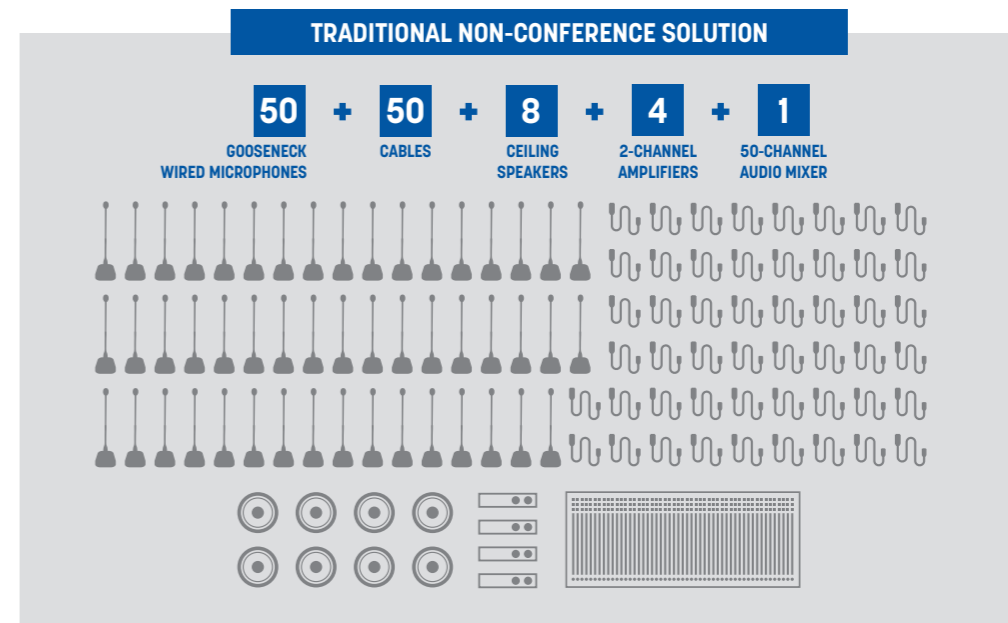
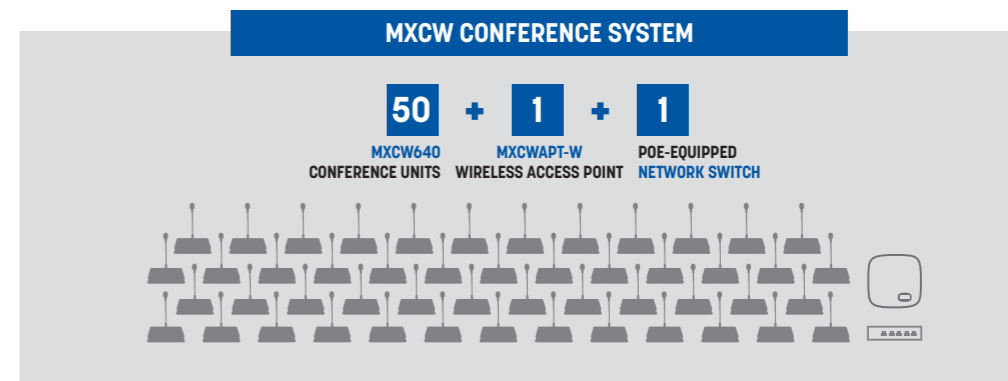

Application: FLEXIBLE ROOM

Presentation - Panel Discussion - Q&A

- Off-site meetings can be an expensive waste of time if attendees cannot fully participate in the discussion. Typical in-room sound systems are only designed to amplify the presenter's voice, and miss the contributions of other participants.
- MXCW Conference System is a versatile audio solution that extends full coverage to every attendee without the labor of routing and securing audio cables.
- Network monitoring allows a technician to monitor battery levels from a PC or tablet (IOS/Android).

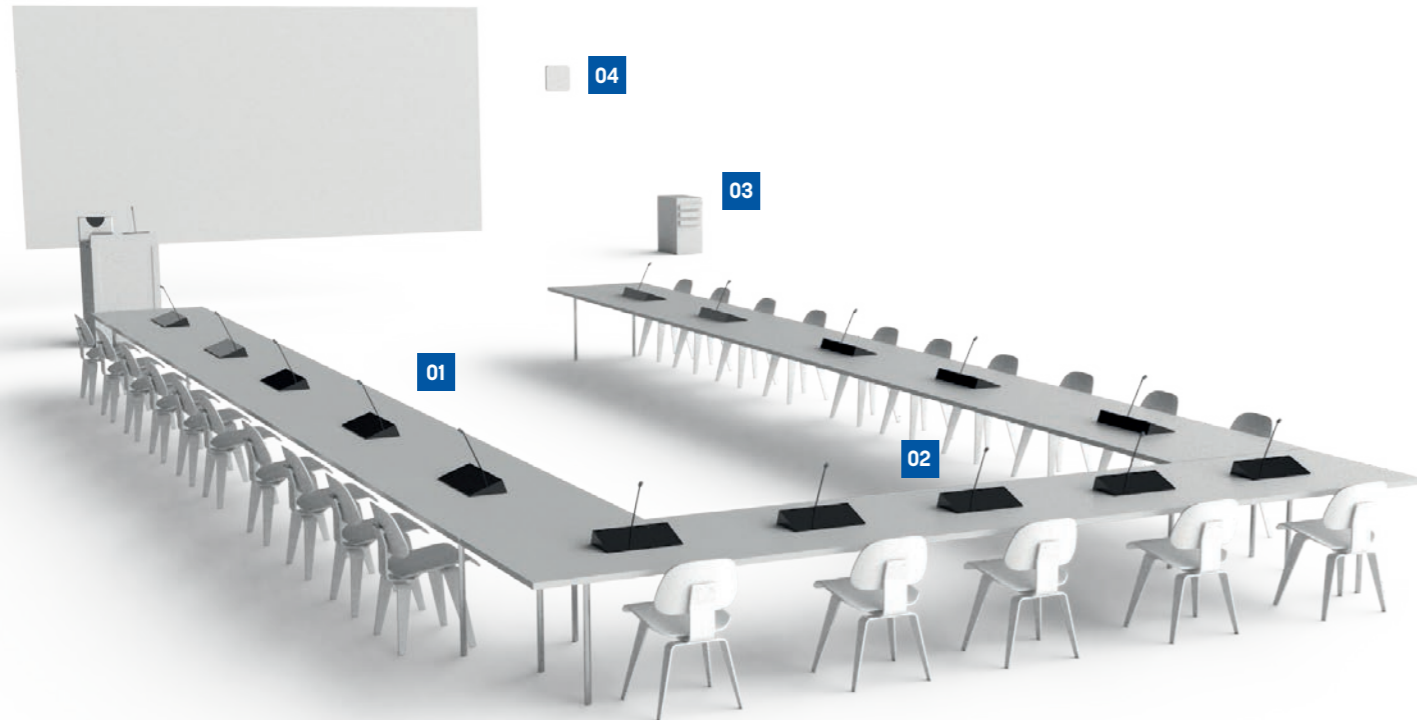

- 01** MXCW640
Wireless Touchscreen Conference Unit
- 02** MXCW640
Wireless Touchscreen Conference Unit configured as Chairman
- 03** MXCWNCSE
Networked Charging Station
- 04** MXCWAPT-W
Wireless Access Point Transceiver

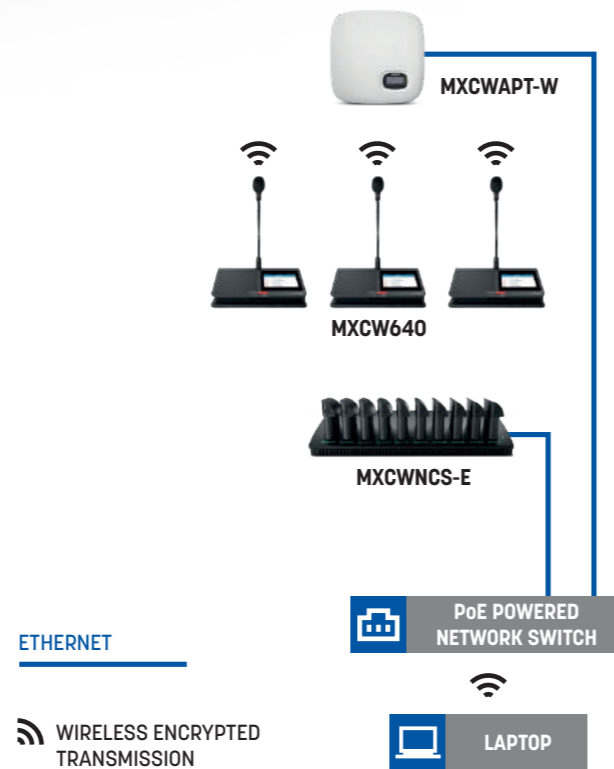

ETHERNET

WIRELESS ENCRYPTED TRANSMISSION

LAPTOP

Application: BOARDROOM

Discussion - Conferencing - Collaboration - Presentation

- In boardrooms with long tables, it can be difficult to hear people seated at the far end. With Microflex Complete Wireless, each participant has their own conference unit with an integrated microphone and loudspeaker so that everyone can hear each other perfectly.
- Wireless convenience means there are no holes to drill and the system can be put away when not needed.
- Robust encryption keeps sensitive meeting content secure.

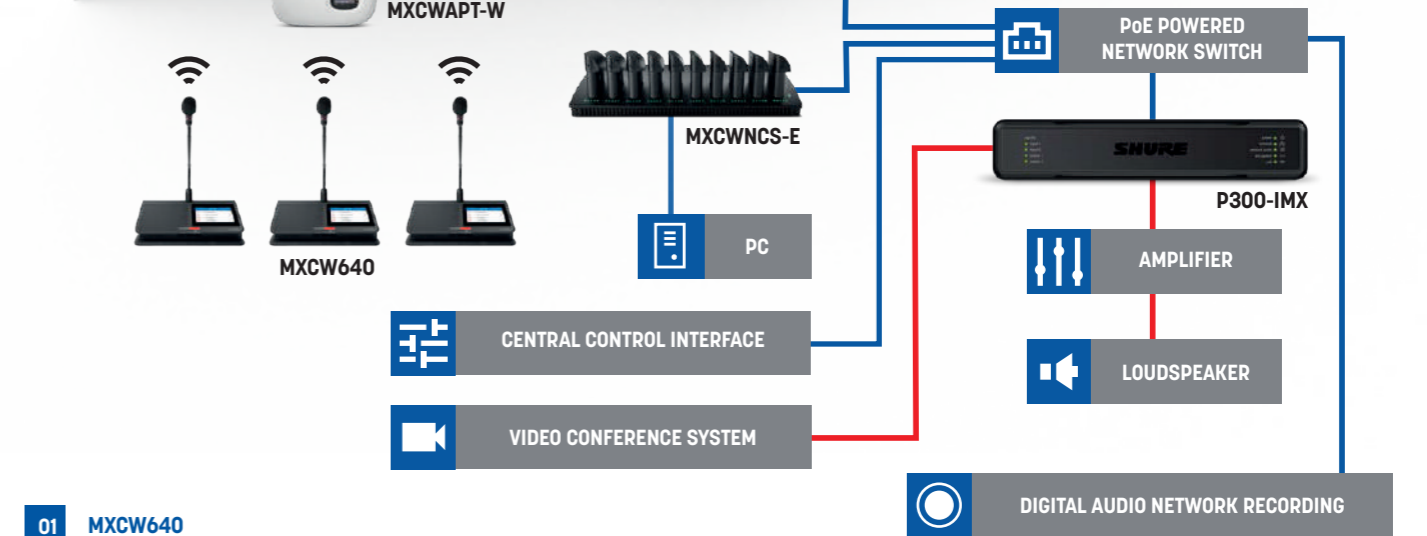

- 01** MXCW640
Full Featured Conference Unit
- 02** MXCWNCSE
Networked Charging Station
- 03** MXCWAPT-W
Wireless Access Point Transceiver
- 04** P300-IMX
IntelliMix® Audio Conferencing Processor

ANALOG AUDIO

ETHERNET

WIRELESS ENCRYPTED TRANSMISSION

Presentation - Discussion - Remote Campus

- At seminars and training events, attendees need to be able to understand complex information and ask questions comfortably, while the instructor needs to know that learning is successful.
- MXCW Conference System makes it easy for attendees to hear clearly, ask questions, and respond to instructor polls.
- The system can connect to third-party streaming equipment to include remote participants.
- Wireless convenience allows flexible seating to be reconfigured without moving cables.

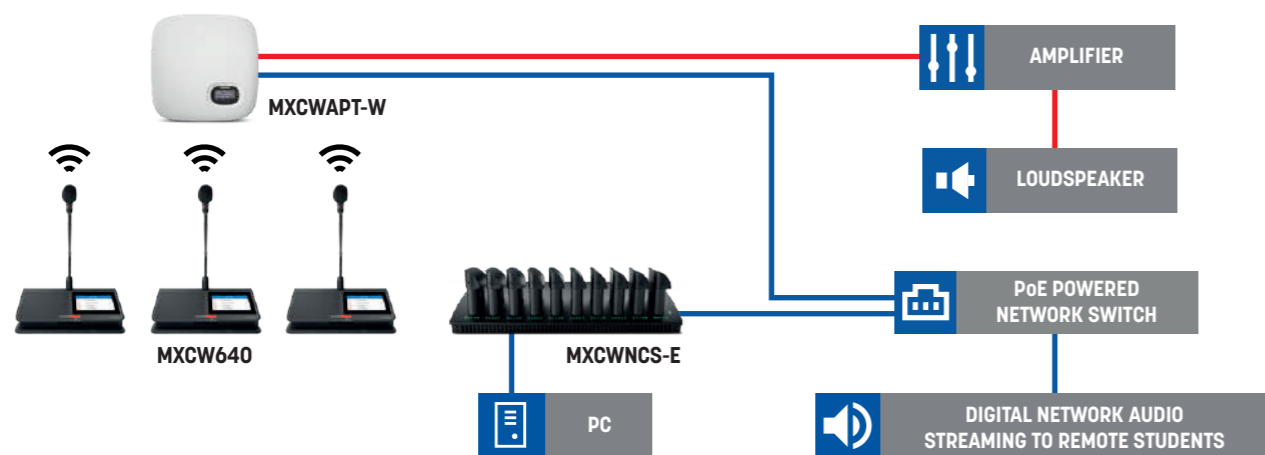

- 01** MXCW640
Wireless Touchscreen Conference Unit
- 02** MXCWAPT-W
Wireless Access Point Transceiver
- 03** MXCWNCS-E
Networked Charging Station

- Liaison AUDIO
- ETHERNET
- WIRELESS ENCRYPTED TRANSMISSION

MXCW640: touchscreen wireless conference station



Wireless digital conference station with high-resolution color touchscreen configurable in modes: chairman, single delegate, double delegate, interpreter, room microphone, listener and outside call.

- The unit incorporates speaking and function buttons, a gooseneck microphone connector, a loudspeaker, two channel selectors, an NFC card reader and a touch screen allowing numerous functionalities (control of microphone, conference control, voting).
- 4.3"/110mm capacitive touchscreen for voting or viewing speaker information, etc.
- 2 channel selectors, each with a 3.5mm headphone jack.
- Participant identification by NFC card.
- 3.5mm connector to add an external participant via smartphone.
- Mini-USB port for off-site battery charging.
- Autonomy > 11 h - Lithium-Ion SB930 battery included.
- Audio encryption.

Model	MXCW640	
GOOSENECK MIC INPUT		
Nominal Input Level	-60dBV	
Frequency Response	20Hz to 20kHz	
THD	0.04% typical	
Dynamic Range	112dBA	
Equivalent Input Noise	-117dBV (A-weighted), typical	
Input Impedance	26kΩ - Unbalanced input	
ANALOG AUDIO OUTPUT		
SPEAKER		
Nominal Output Level	72dB SPL @ 0.5m	
Maximum Output Level	89dB SPL @ 0.5m 3% of DHT + noise	
Frequency Response	220Hz to 15kHz	
THD	1% typical	
Dynamic Range	94dBA	
HEADPHONES OUTPUT		
Maximum Output Level	2.1dBV	
Frequency Response	100Hz to 22kHz	
THD	0.04%, typical	
Dynamic Range	101dBA	
Load Impedance	>8Ω, typical	
Configuration	Dual mono	
Connector	TRRS 3.5mm Jack	
RF		
WLAN Standard	IEEE 802.11a,g	
RF Frequency Bands	5GHz U-NII 1, U-NII 2 D.F.S & U-NII 2 Extended D.F.S.	
Output Power	1mW (Low), 5mW (Medium), 13mW (High), 25mW (Max)	
Antenna Type	Internal Bi-level Dual-Band PIFA	
POWER		
Battery Type	SB930 - Lithium-Ion	
Voltage	3V to 4.2V	
Capacity	35Wh - 9600mAh	
USB		
Input voltage range	4.5 to 5.5V	
Power consumption	Maximum 10W	
Recommended cable	28 AWG/1 P + 22 AWG/2 C, < 1.5 m	
USER INTERFACE		
Display Type	Color TFT LCD with Capacitive TouchScreen	
Display Size	4.3" (109.2mm)	
Display Resolution	480 x 272 (128 ppi)	
MECHANICAL		
Dimensions (WxHxD)	257.5 x 70.2 x 148mm	
Weight	1.21kg with battery	
Material	Molded Plastic, Die Casted Aluminum	



SB930: rechargeable battery for conference station

- The SB930 rechargeable battery powers the MXCW640 wireless conference unit for over 11 hours.
- LED indicators on the battery show charging status quickly and easily.
- Charging in the MXCWNCS-E network charging station takes only 1.5 hours for a 50% charge and 4 hours for a 100% charge.
- Included with MXCW640
- 3-cell battery with Smart Lithium-Ion technology
- Remote monitoring of remaining battery life in hours and minutes



Model	SB930
Material	Molded plastic
Dimensions (WxHxD)	65 x 101.5 x 31mm
Weight	184g

MXCWNCS-E: 10-batteries networked charging station



- The MXCNCS is a network charging station allowing the charging of ten Lithium-Ion SB930 batteries in four hours.
- It has LED bargraphs displaying the charge status of each battery and an RJ45 port for controlling the charge remotely.
- Charge 10 batteries to 50% in 1.5 hours, to 100% in 4 hours.
- Storage mode to extend battery life when system is not in use.
- Rack or wall mounting kit included.

Model	MXCWNCS-E	
NETWORK		
Interface	Ethernet Gigabit - Dante digital audio	
Speed	10 / 100Mbps	
Addressing Capability	DHCP or Manual IP address	
Cable Type	Cat5e or upper	
Connector	1x RJ45	
LED	Status (Green) / Link Speed (Amber)	
USER INTERFACE		
Charge	5 LEDs per bay for charging indication	
Ethernet	2x LED	
Status	1x LED - Power, Reset, Network Reset, Storage Mode	
MECHANICAL		
Dimensions (WxHxD)	438.9 x 72.4 x 193.5mm	
Weight	2.825kg	
Material	Molded Plastic, Steel	
Mounting Type	Tabletop, wall mount or rack (4U rackspace required)	

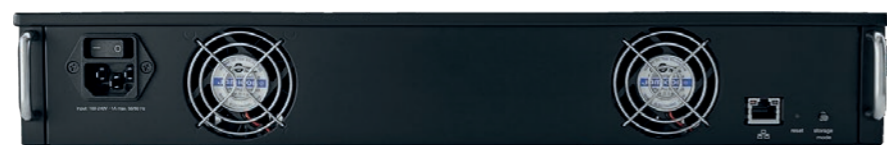

MXCWAPT-W: wireless access point transceiver

- The MXCWAPT-W access point manages audio routing, frequency coordination and system control for up to 125 MXCW640 wireless conference units.
- Thanks to its real-time frequency scanner, it automatically selects the best channel in the 2.4 GHz and 5 GHz frequency bands (including the spectrum subject to DFS) and switches the channels to avoid any potential interference.
- The access point has both Dante™ and analog audio inputs and outputs, and uses a single Ethernet connection for power, audio, and control.
- Bidirectional HF link allowing audio channels to be transported in both directions and ensuring real-time control of all parameters.
- AES-128 encryption to ensure the confidentiality of meetings.
- Dante™ digital network with 10 inputs and 10 outputs.
- Analog audio input and output on XLR.
- Built-in matrix for managing Dante™ and analog inputs/outputs; Management of groups of MXCW640 stations.
- High-cut, low-cut and AGC filters available on each input.



Model	MXCWAPT-W	
ANALOG AUDIO INPUT		
Maximum Input Level	24.9dBV Line - 0dB Gain 10.3dBV Aux - 0dB Gain	
Frequency Response	22Hz to 20kHz	
THD	0.03% typical Line - 0dB Gain	
Dynamic range	115dB / 112dB Line/Aux - 0dB Gain	
Connector	XLR-3-pin female	
ANALOG AUDIO OUTPUT		
Maximum Output Level	4.3dBV (Dante & analog Gain 0dB)	
Frequency Response	1Hz to 20kHz	
THD	0.01 % typical	
Dynamic range	100dB (Dante & analog Gain 0dB)	
Load Impedance	> 600Ω	
Connector	XLR-3-pin male	
RF		
WLAN Standard	IEEE 802.11a.g	
RF Frequency Bands	2.4GHz ISM - 5 GHz U-NII 1, U-NII 2 D.F.S & U-NII 2 Extended D.F.S.	
Output Power	1 mW (Low), 5 mW (Medium), 13 mW (High), 25 mW (Max)	
Antenna Type	Internal Bi-level Dual-Band PIFA	
NETWORK		
Interface	Ethernet Gigabit - Dante digital audio	
Link Speed	10 / 100 / 1000Mbps	
Addressing Capability	DHCP or Manual IP address	
Cable type	Cat5e or upper	
Connector	1x RJ45	
LED	Status (Green) / Link Speed (Amber)	
POWER		
Type	PoE (Power over Ethernet), Class 0	
Power consumption	12.95W (max), 6.5W (typical)	
USER INTERFACE		
Display Type	Monochrome FFSTN LCD	
Display Size	46.7 x 18.8mm	
Display Resolution	152 x 78 (78ppi)	
LED Status Indication	Power, Network Audio, RF	
Reset	Pushbutton for Network/Factory Reset	
MECHANICAL		
Dimensions (WxHxD)	242.5 x 47.8 x 241.8mm	
Weight	1.15kg	
Material	Molded Plastic, Die-casted Aluminum	
Mounting Type	Wall or ceiling bracket	



MXCW Conference System components

Gooseneck microphones for MXCW640 station



MXCW640 equipped with MXC406-MS gooseneck

Model	MXC406-MS	MXC416-C	MXC416DF-C	MXC420-C	MXC420DF-C
Capsule	Mini Shotgun	R185B Cardioid			
Connector	Microflex multipin				
Hose	15cm	40cm	DualFlex 40cm	50cm	DualFlex 50cm
Delivered with windscreen	no	yes			

FLIGHT-MXCW-T10

Flight touring for 10 MXCW stations

- Flight case specially designed for the MXCW wireless conference system.
- It can contain 10 stations equipped with their gooseneck, the access point, the charger with mains pre-cabling, and the cabling.
- A roller tray is available as an option.



FLIGHT-MXCW-I10

FLIGHT-MXCW-I20

Flights installation for 10 ou 20 MXCW stations

- Wheeled flight cases specially designed for the fixed installation of the MXCW wireless conference system.
- Their design makes it easy to move the system from one room to another when necessary.
- They contain several drawers for storing 10 sets (FLIGHT-MXCW-I10) or 20 MXCW sets (FLIGHT-MXCW-I20), equipped with their gooseneck, access point, chargers and cabling.



PLANCHE-MXCW

Rolling tray for MXCW-T10



PUBLIC ADDRESS

ACOUSTIC >



Omnidirectionality and broad coverage

- **Recognized since 1992 and protected by an international patent**, so far the omnidirectional speakers created by MAJORCOM have not been equalled by any other speaker as regards to fitting large areas with PA particularly in the large-scale industry.
- Faced with marketing catch phrases such as "directional loudspeaker with an exceptional coverage surface", "wide-dispersion sphere", "space technology speaker" and "wide-dispersion and ceiling mounted and...directional speaker", **MAJORCOM had to re-establish the reality of physics laws on sites.**
- Thus, we were led to carry out **comparison tests between the most famous trade names products.** Those tests were performed under the same setting up conditions.
- **The efficiency of MAJORCOM omnidirectional products was confirmed upon the three following points:**
 - Sound quality:** a quality sound can be played without any kind of device,
 - Homogeneous coverage:** the patented reflector is the obvious and most efficient solution to reach a homogeneous and substantial coverage surface,
 - Optimal intelligibility:** the RASTI measures showed that our products met the intelligibility requirements in any kind of situation.
- Thus, it could have been noted that the sound projector-typed products, spheres or usual ceiling-mounted speakers defined as having exceptional coverage capacities keep on being directional products with a low dispersion capacity.
- Therefore, using such products for substantial areas produce public address systems with successions of "surges", and "gaps" to the detriment of the listening comfort and intelligibility.

Qualities of omnidirectional speakers

GROUND COVERAGE

- For the same power and set up at the same height, these speakers (figure S1) guarantee a 3 to 5 times wider coverage than standard speakers, sound projectors, spheres, etc. (figure S2).
- Thanks to their original design and the presence of a reflector, these speakers are provided with a 360° horizontal and 160° vertical directivity.

OMNIDIRECTIONALITY AND REVERBERATION

- To improve intelligibility in a reverberating environment, the speaker-listener distance has to be reduced.
- Now, the distribution of the sound energy in a large diffusion angle enables to bring the omnidirectional speakers closer to the listeners without bothering them. This is absolutely not the case for standard directional speakers.

QUALITY OF THE SOUND MESSAGE

- The intelligibility of a sound message is up to 60% provided by treble frequencies.
- With standard speakers, trebles are present with other frequencies only over a small ground surface (S2).
- For the omnidirectional speakers, treble frequencies are distributed as well as other frequencies, over the whole S1 surface which is 3 to 5 times higher than S2.

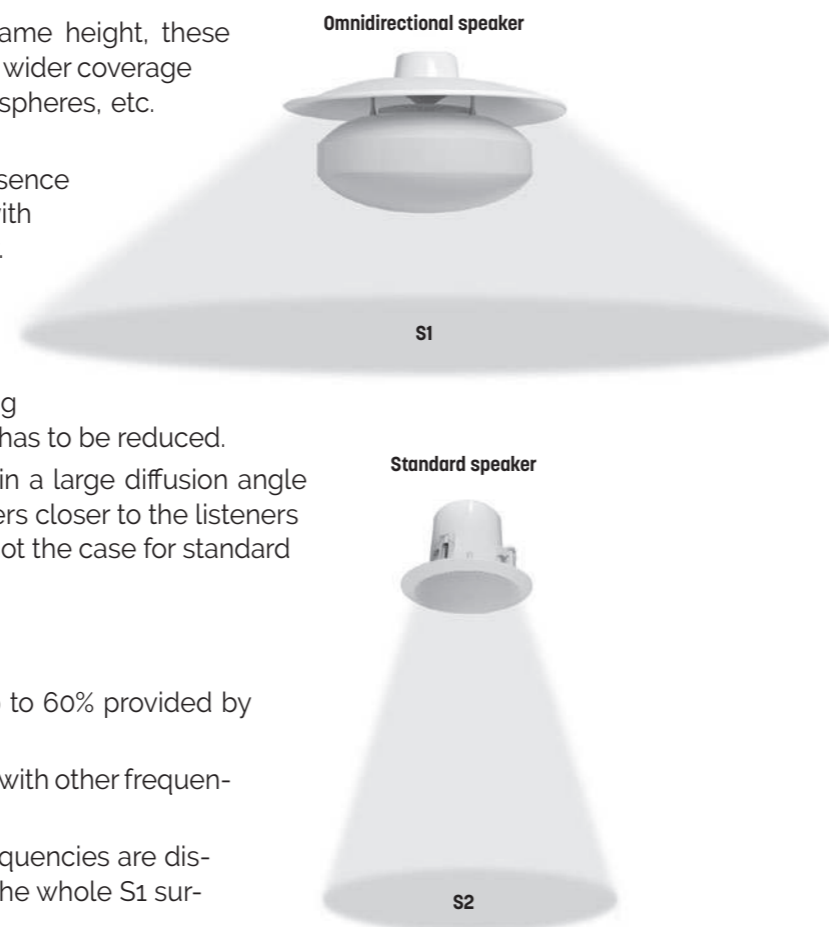

Omnidirectional speaker

IMC 300T/VA

2-way Omnidirectional speaker - 30W EN 54 24



Patented omnidirectionality

Created by MAJORCOM and protected by an international patent, this powerful omnidirectional speaker is specifically adapted to the sound systems of large and very large volumes with loud noise levels: shopping centres, sports halls, ice rinks, swimming pools, airports, etc. Equipped with a heavy-duty, 16cm 2-way speaker and 30W a high-performance 100V line transformer, the IMC 300T/VA has a near Hi-Fi quality.

AUDIO QUALITY

It broadcasts quality sound without any frills.

SOUND COVERAGE

The patented reflector has earned the reputation of being the most efficient solution for achieving a large and homogeneous coverage zone (3 to 5 times larger than traditional enclosures, sound projectors, etc.).

OPTIMAL INTELLIGIBILITY

RASTI measurements have shown that our products respond in all cases to the intelligibility requirements of safety standard EN-5424 (Type A).

- 3 steel mounting slings (80cm) make it possible to suspend it securely.
- Optional specific RAL painting available : **PEINT OMNI** (minimum 6 pcs).

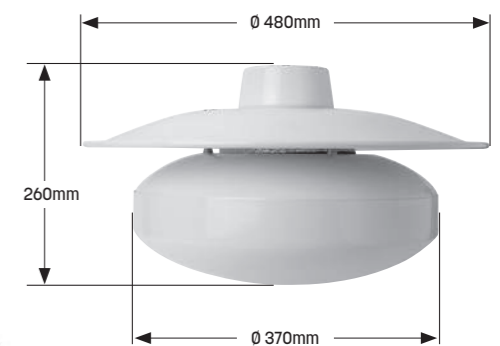

Horizontal directivity

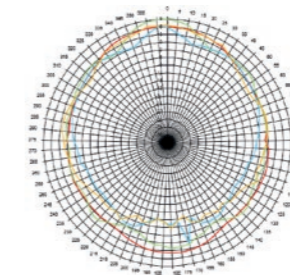

Vertical directivity

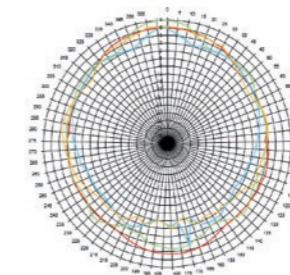

Bandwidth

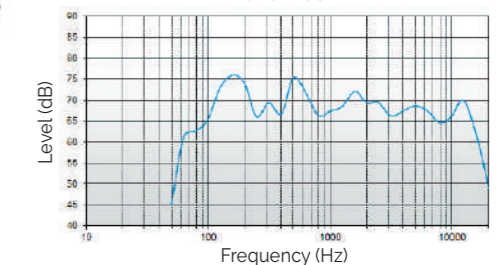

Model	IMC 300T/VA
Body & grill	Metal
Nominal power	30W
Nominal Impedance	330Ω
Power 100V Line	30/20/10W
Impedance	330/500/1,000Ω
Bandwidth	60Hz - 20kHz
Sensitivity (1W/1m)	84dB
SPL MAX 1m	98.8dB
Directivity (H-V) @ 500Hz	360° - 360°
Directivity (H-V) @ 1kHz	360° - 360°
Directivity (H-V) @ 2kHz	200° - 200°
Directivity (H-V) @ 4kHz	275° - 275°
Speaker	6.5" - 2 ways
Cone	Protected paper
Dimensions [mm]	Ø480/Ø370 x (H)260
Weight	4.5kg
Operating temperature	-15 to +55°C
Protection Index	IP54
Color	White

Ceiling speaker

CSE 56T VA

6W Ceiling Speaker 

- The 6W powered speaker is equipped with a 130mm full-range loudspeaker and a 100V transformer with 3 power adjustments 6W, 3W and 1.5W.
- Thanks to an innovative air flow system, the CSE 56T VA provides sound characteristics which are attributed to a conventional bass speaker.
- An extremely flat construction method allows a low mounting depth of only 70mm, with less than 1kg product weight.
- For additional reliability the speaker is impregnated against wetness.
- Quick and easy mounting with spring clamps and short tension distance. Perfectly suitable for installations where the installation depth is very limited. This speaker is suitable for a ceiling strength of about 3 – 45mm.
- Optional specific RAL painting available : **PEINT PLAFONNIER** (minimum 25 pcs).
- Optional metallic fire dome available: **FD CSE 56T VA**



Model	CSE 56T VA
Speaker	5"
Body & grill	Metal, plastic PET contact protection
Nominal power	6W
Nominal Impedance	666Ω
Power 100V Line	6 / 3 / 1,5W
Impedance	1,667 / 3,333 / 6,667Ω
Bandwidth	104 - 17,200Hz
Sensitivity (1W/1m)	86,8dB
SPL MAX 1m	98,3dB
Directivity (H-V) @ 500Hz	180°
Directivity (H-V) @ 1kHz	180°
Directivity (H-V) @ 2kHz	140°
Directivity (H-V) @ 4kHz	85°
Cone	Coated paper
Dimensions	Ø 181,5 x D 65mm (181,5 x 91,5mm fire dome)
Ceiling Cut-out	Ø 156mm
Weight	0,51kg (0,71kg with fire dome)
Operating temperature	-10°C / +55°C
Protection Index	IP 21C
Color	RAL 9016



FD CSE 56T VA

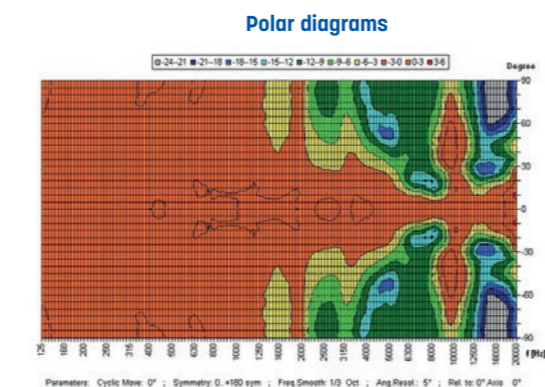
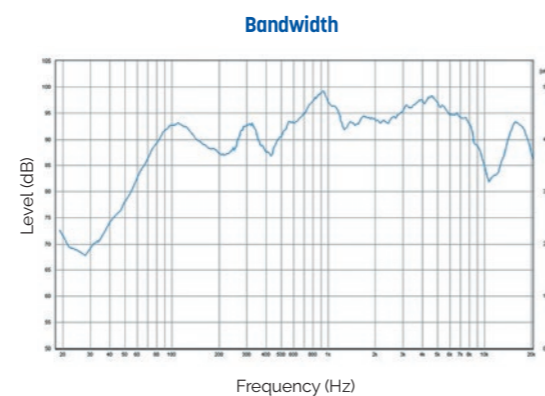

Ceiling speaker

P 101T

1-way ceiling speaker 6W

- Ceiling speaker with high quality 100V transformer integrating most decorations.
- The sound quality and the price make this product an element of choice to achieve a so-called economical sound system.

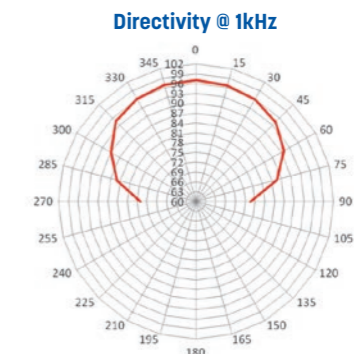
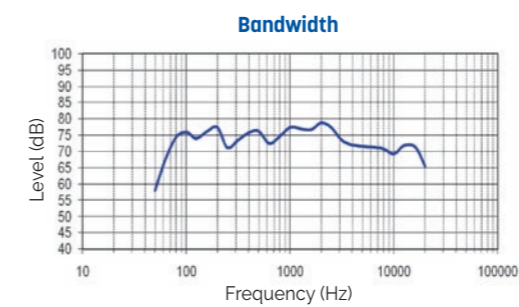

Model	P 101T
Speaker	4"
Body & grill	ABS / Metal
Nominal power	6W
Peak power	10W
100V line power	3/6W
Bandwidth	85 to 15,000Hz
Sensitivity 1W / 1m	87dB
Directivity @ 1kHz	90°
Dimensions (Ø x D)	174 x 60mm
Ceiling Cut-out	Ø 155mm
Weight	0,5kg

Ceiling speaker

P 25T

1-way ceiling speaker 15W for wet places

- ABS ceiling lights fitted with a plastic loudspeaker, specially adapted for sound systems in bathrooms, swimming pools, saunas, etc.
- Supplied with a remote 100V line transformer in an IP 55 box.
- Optional specific RAL painting available : **PEINT PLAFONNIER** (minimum 14 pcs).

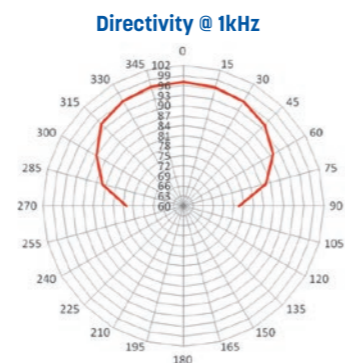
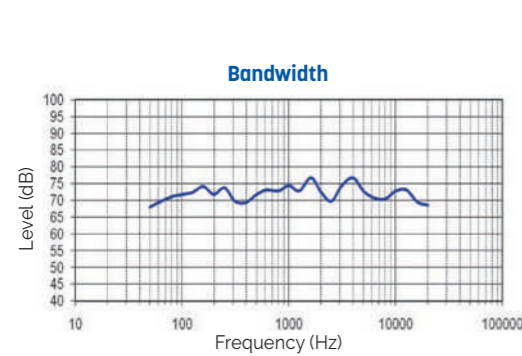

Model	P 25T
Speaker	5" - Plastic
Body & grill	ABS
Nominal power	15W
100V line power	5/7/15W
Bandwidth	50 to 20,000Hz
Sensitivity 1W / 1m	82dB
Directivity @ 1kHz	90°
Dimensions (Ø x D)	190 x 90mm
Ceiling Cut-out	Ø 145mm
IP 55 Box dimensions	80 x 80 x 50mm
Weight	HP: 0.450kg - Box: 0.500kg

Ceiling speaker

P 25

30W - 8Ω 1-way ceiling speaker for wet places

- ABS ceiling lights fitted with a plastic loudspeaker, specially adapted for sound systems in bathrooms, swimming pools, saunas, etc.
- Optional specific RAL painting available : **PEINT PLAFONNIER** (minimum 14 pcs).

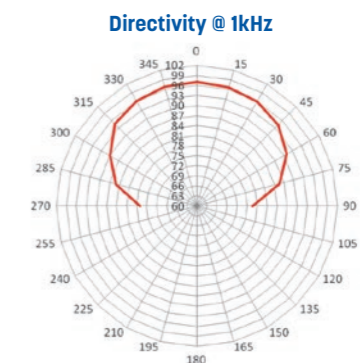
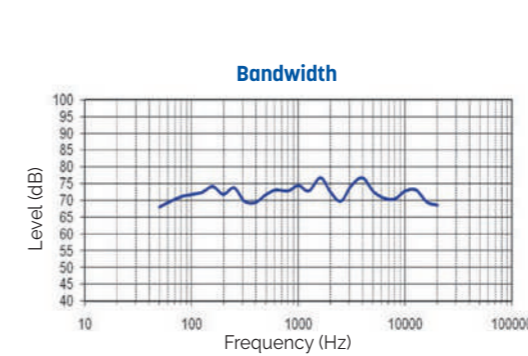

Model	P 25
Speaker	5" - Plastic
Body & grill	ABS
Nominal power	30W
100V line power	40W
Bandwidth	50 to 20,000Hz
Sensitivity 1W / 1m	82dB
Directivity @ 1kHz	90°
Dimensions (Ø x D)	190 x 90mm
Ceiling Cut-out	Ø 145mm
Weight	0.450kg

Ceiling speaker

EC 6

6W Ceiling Speaker

- Ceiling speaker with high quality 100V line transformer fits in most decorations.
- Its fixation allows it to be easily mounted on 35mm walls or ceilings.

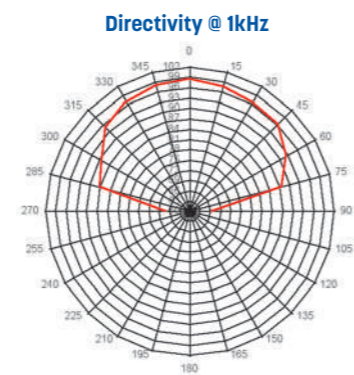
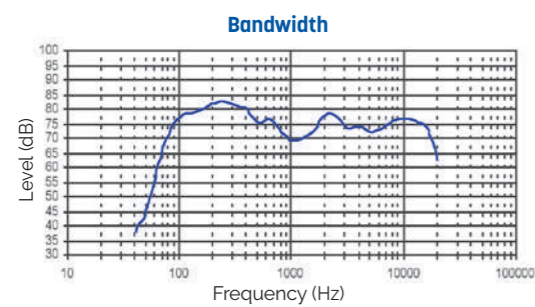

Model	EC 6
Speaker	5" - Bicone
Body & grill	Metal / Epoxy
Nominal power	6W
Peak power	10W
Power 100V Line	1.5/3/6W
Bandwidth	90 to 16,000Hz
Sensitivity (1W/1m)	90dB
Directivity @ 1kHz	90°
Dimensions (Ø x D)	200 x 75mm
Ceiling Cut-out	Ø 165mm
Weight	1.3kg

Ceiling speaker with a fireproof cover

EC 6TC

2-way ceiling speaker 20W - 100V - 8Ω

- Ceiling speaker with a fireproof cover fitted with a 5" diameter 2-way plastic loudspeaker and a 100V line transformer.

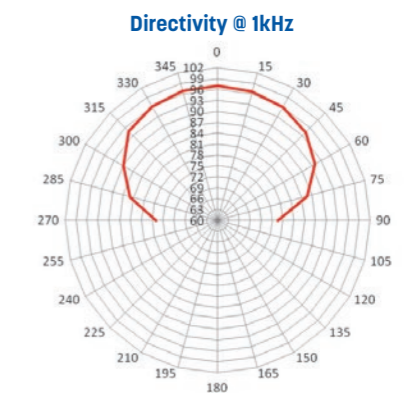
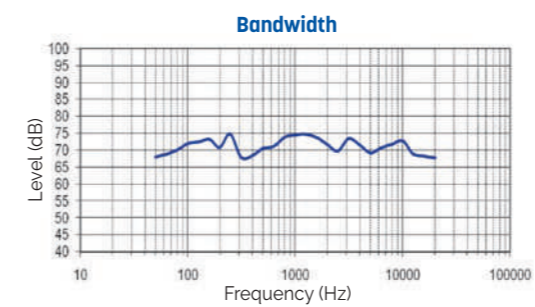

Model	EC 6TC
Speaker	5" - 2-way
Body & grill	ABS / Metal
Nominal power	20W
Peak power	30W
100V line power	2.5/5/10/20W - 8Ω
Bandwidth	100 to 20,000Hz
Sensitivity 1W / 1m	89dB
Directivity @ 1kHz	90°
Dimensions (Ø x D)	203 x 145mm
Ceiling Cut-out	Ø 170mm
Weight	1.8kg

Ceiling speaker

P 802T-W**2-way ceiling speaker 20W - 16Ω - White****P 802T-B****P 802T-W black edition**

- Loudspeakers with an 8" enforced polypropylene woofer and 1" tweeter for an exceptional sound reproduction. These speakers are ideal for the distribution of microphone calls and background music at a higher volume level.
- Thanks to a steel grill and ABS housing, they can fit in most of interior. With their 100V transformer line with 2.5/5/10/20W power taps and a 16Ω connection, you can adjust the SPL level for all applications you need.
- Easy to install with only 3 screws and a magnetic grill.



Bandwidth and impedance

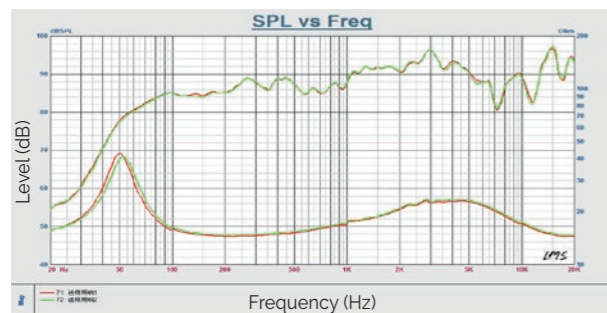

Bandwidth according to power setting

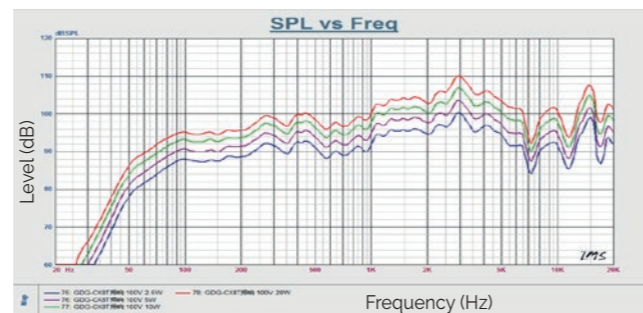

Model	P 802T-W / P 802T-B
Speaker	Woofer: 8" polypropylene + tweeter 1"
Body & grill	ABS plastic and steel
Nominal power	30W
Peak power	45W
100V line power	2.5 / 5 / 10 / 20W - 16Ω
Bandwidth	50 to 20,000Hz
Sensitivity 1W / 1m	88dB
Directivity @ 1kHz	180°
Dimensions without grill (Ø x D)	272 x 105mm
Ceiling Cut-out	Ø 248mm
Weight	1,86kg

Ceiling speaker

P 515T VA**2-Way Ceiling Speaker - 15W** EN 54 24

- P 515T VA is a 2 way bass reflex ceiling speaker suitable for high quality installation.
- Fitted with a 5" speaker, a neodymium tweeter and a 100V transformer with 4 power taps, it offers a very high sound quality.
- Easy installation via screw mounting system.
- Optional specific RAL painting available : **PEINT PLAFONNIER** (minimum 25 pcs).

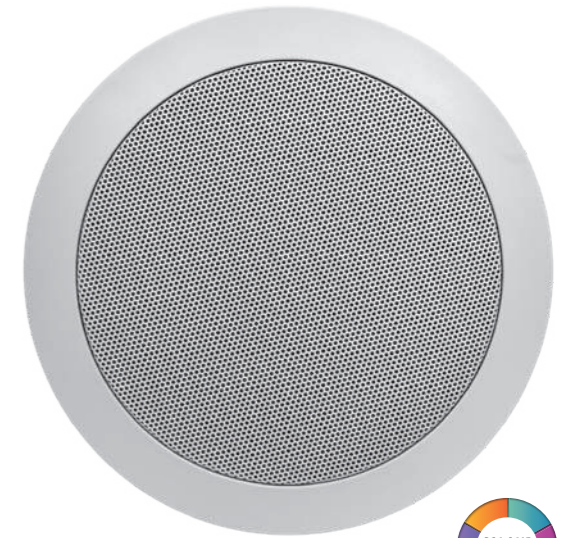
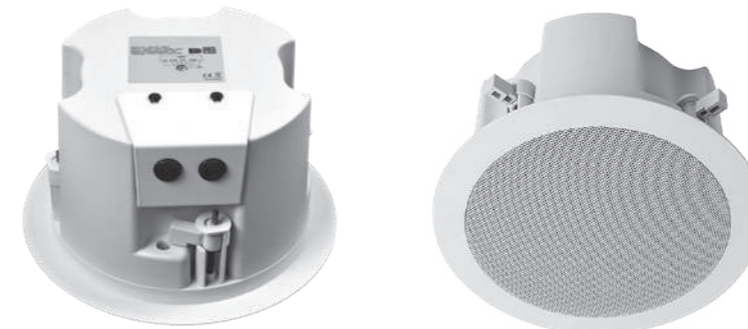

Polar diagrams

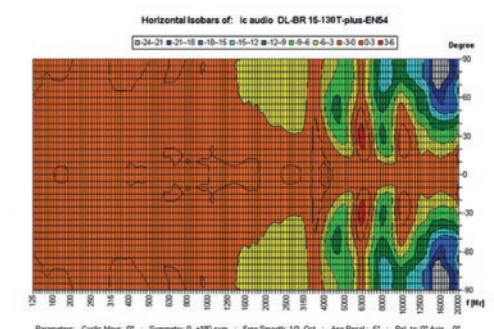
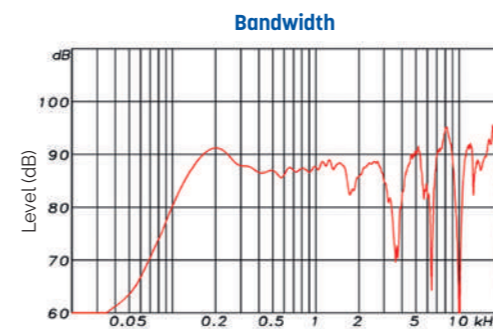

Model	P 515T VA
Body & grill	ABS
Nominal power	15W
Nominal Impedance	667Ω
Power 100V Line	15 / 7.5 / 3.75 / 1.9W
Impedance	667 / 1,333 / 2,667 / 5,263Ω
Bandwidth	100 - 22,800Hz
Sensitivity (1W/1m)	86,2dB
SPL MAX 1m	98dB
Directivity (H-V) @ 500Hz	180°
Directivity (H-V) @ 1kHz	180°
Directivity (H-V) @ 2kHz	145°
Directivity (H-V) @ 4kHz	95°
Speaker	5"
Dimensions (mm)	Ø 213 x P 152
Ceiling Cut-out	Ø 178mm
Weight	1,73kg
Operating temperature	-10°C ~+55°C
Protection Index	IP 21C
Color	RAL 9016

Ceiling speaker

P 630T VA

2-Way Ceiling Speaker - 30W EN 54 24

- P 630T VA is a 2 way bass reflex ceiling speaker suitable for high quality installation.
- Fitted with a 6.5" speaker, a neodymium tweeter and a 100V transformer with 4 power taps, it offers a very high sound quality.
- Easy installation via screw mounting system.
- Optional specific RAL painting available : **PEINT PLAFONNIER** (minimum 14 pcs).

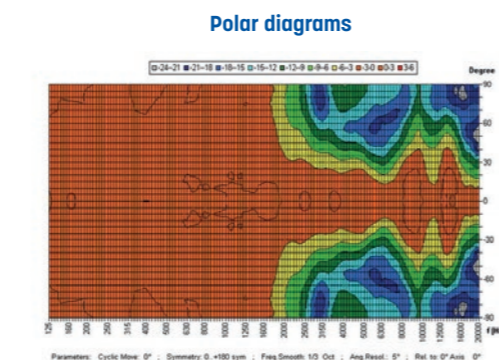
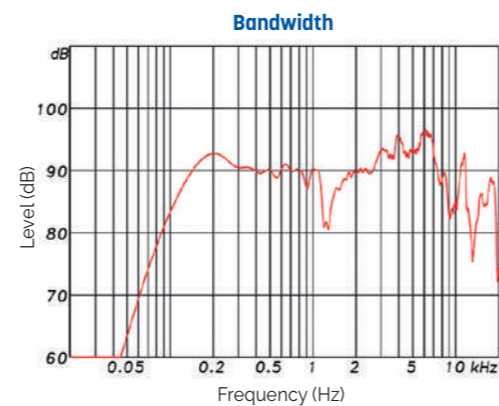

Model	P 630T VA
Body & grill	ABS
Nominal power	30W
Nominal Impedance	333Ω
Power 100V Line	30 / 15 / 7.5 / 3.75W
Impedance	333 / 667 / 1,333 / 2,667Ω
Bandwidth	87 - 19,300Hz
Sensitivity (1W/1m)	89,8dB
SPL MAX 1m	110,2dB
Directivity (H-V) @ 500Hz	180°
Directivity (H-V) @ 1kHz	180°
Directivity (H-V) @ 2kHz	115°
Directivity (H-V) @ 4kHz	62°
Speaker	6.5"
Dimensions (mm)	Ø 239,5 x D 176,5
Ceiling Cut-out	Ø 210mm
Weight	2,27kg
Operating temperature	-10°C ~+55°C
Protection Index	IP 21C
Color	RAL 9016

Ceiling speaker

P 860T VA

2-Way Ceiling Speaker - 60W EN 54 24

- P 860T VA is a 2 way bass reflex ceiling speaker suitable for high quality installation.
- Fitted with a 8" speaker, a neodymium tweeter and a 100V transformer with 4 power taps, it offers a very high sound quality.
- Easy installation via screw mounting system.
- Optional specific RAL painting available : **PEINT PLAFONNIER** (minimum 14 pcs).

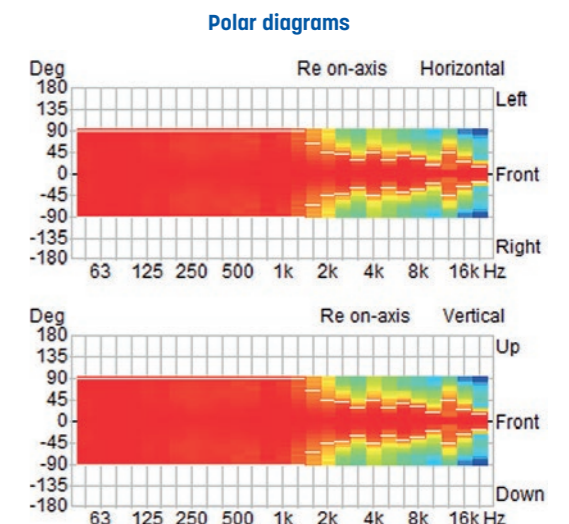
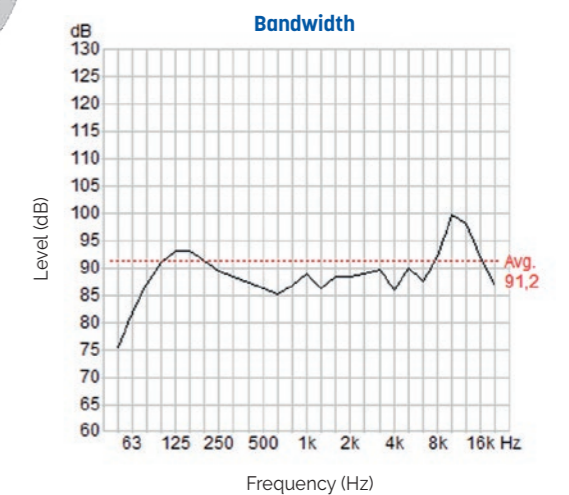
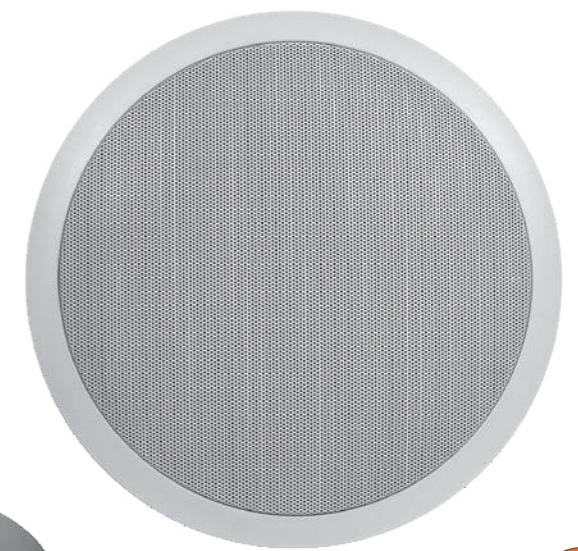

Model	P 860T VA
Body & grill	Metal
Nominal power	60W
Nominal Impedance	167Ω
Power 100V Line	60 / 30 / 15 / 7,5W
Impedance	167 / 333 / 667 / 1,333Ω
Bandwidth	50 - 24,000Hz
Sensitivity (1W/1m)	91,2dB
SPL MAX 1m	110,7dB
Directivity (H-V) @ 500Hz	180°
Directivity (H-V) @ 1kHz	165°
Directivity (H-V) @ 2kHz	130°
Directivity (H-V) @ 4kHz	80°
Speaker	8"
Dimensions (mm)	Ø 319 x D 254
Ceiling Cut-out	Ø 302mm
Weight	4,7kg
Operating temperature	-10°C ~+55°C
Protection Index	IP 21C
Color	RAL 9016

Ceiling speaker

P 325T

2-way fiberglass ceiling speaker - 15W

- Ceiling speaker equipped with a 6.5" 2-way fiberglass loudspeaker and a 100V high quality transformer.

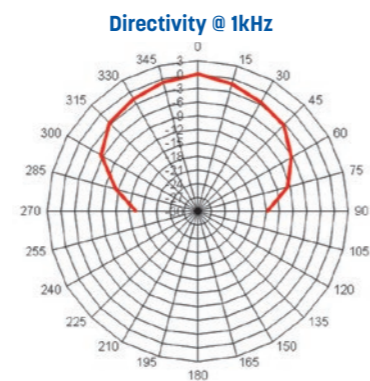
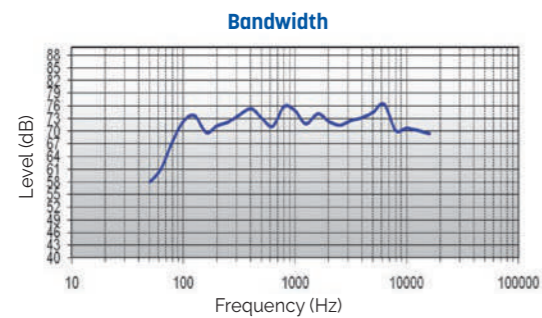

Model	P 325T
Speaker	6.5" - 2-way - fiberglass
Body & grill	ABS / Aluminium
Nominal power	15W
100V line power	5/7.5/15W
Bandwidth	90 to 16,000Hz
Sensitivity 1W / 1m	87dB
Directivity @ 1kHz	90°
Dimensions (Ø x D)	226 x 115mm
Ceiling Cut-out	Ø 194mm
Weight	1.5kg

Ceiling speaker

CS-430F

2-way bass reflex ceiling speaker - 30W - 8Ω

- 2-way bass reflex ceiling speaker with premium grade 4" transducer, 1/2" dome tweeter and 100V transformer.
- Transformer taps rotary switch directly reachable under the front grill.
- Graceful design and easy installation.
- Suitable for high quality installation as: conference room, exhibition room, restaurant...

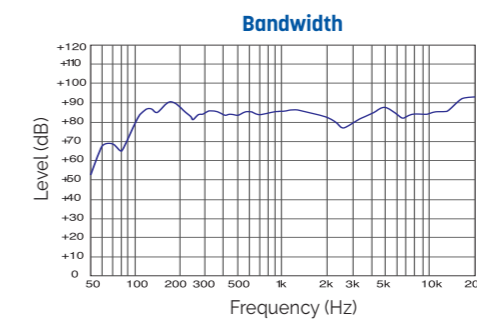

Model	CS-430F
Speaker	4" - 1/2" dome Tweeter
Body & grill	ABS
Nominal power	30W
Peak Power	30W
100V line power	7.5/15/30W - 8Ω
Frequency response	100 to 20,000Hz
Sensibility 1 W / 1 m	84dB
Power tap	Euroblock Terminal
Dimensions (Ø x D)	230 x 168mm
Ceiling Cut-out	Ø 205mm
Weight	1.8kg

Ceiling speaker

PSUB 120T 120W Ceiling subwoofer

- This 120W powered subwoofer is equipped with a 200mm high-performance system featuring 4 power adjustments 120/60/30/15W.
- PSUB 120T offers an amazing deep bass response which gives your voice alarm installation a rich sound quality.
- Power tapings are easily set at the front of the speaker, a low impedance operation at 4ohm is also possible. The crossover frequency is set to 135Hz. You can change the phase 180° by a switch at the front. To make things perfect the metal housing in RAL 9016 guarantees long-term durability.
- Protection class IP 21C secures the speaker against the risks of environmental influences. The speaker chassis is impregnated against wetness. Easy installation via screw mounting system. Perfectly suitable for installations where high sound quality is demanded.
- Optional specific RAL painting available : **PEINT PLAFONNIER** (minimum 14 pcs).

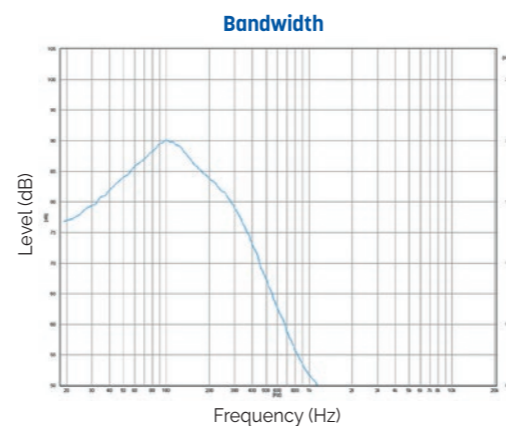
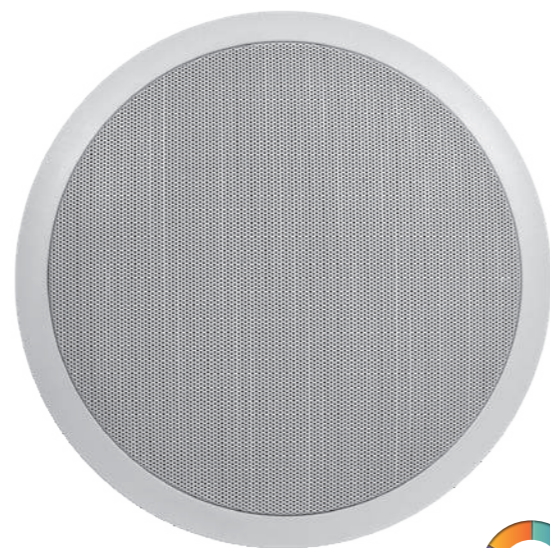

Model	PSUB 120T
Body & grill	ABS / Metal
Nominal power	120W
Nominal Impedance	83Ω
Power 100V Line	120 / 60 / 30 / 15W
Impedance	83 / 167 / 333 / 667Ω - 4Ω
Bandwidth	32 - 280Hz
Sensitivity (1W/1m)	87dB
SPL MAX 1m	107,8dB
Dimensions (mm)	Ø 319 x P 250
Ceiling Cut-out	Ø 302mm
Weight	6.4kg
Operating temperature	-10°C ~+55°C
Protection Index	IP 21C
Color	RAL 9016

Ceiling speaker

M-INVISI-10W 10W Lay-In Ceiling-Tile Speaker



- Build-in speaker for false ceilings
- Invisible (hidden speaker)
- Tool-free ultra-fast Installation (< 2 minutes)
- Modular (easy to move)
- Standard dimensions : 600 x 600 mm ceiling tile
- Monobloc ceiling tile structure

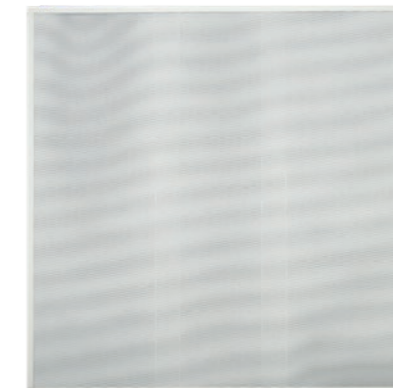

- Thanks to its invisible design, the M-INVISI-10W speaker fits in harmoniously into any space while delivering high-quality sound.
- Installation is child's play, with an ultra-fast, tool-free method taking less than 2 minutes !
- With standard dimensions (600 x 600 mm),

M-INVISI-10+W adapts easily to most ceiling configurations, ensuring maximum compatibility.

- Its modular design makes it easy to move to suit your needs.
- The one-piece structure ensures a solid and secure installation, guaranteeing long-term durability.

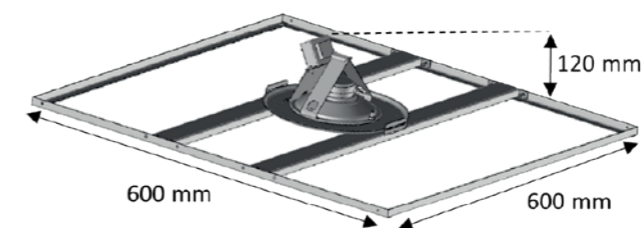

Model	M-INVISI-10W
Nominal power	10 W
Power 100V Line	10 / 6 / 3 W
Frequency range	70 Hz to 20 kHz
SPL (1W/1m)	94 dB
Directivity (-6dB)	166°
Color	White
Material	Metal
Dimensions	600 x 600 mm
Weight	3,8 kg
Connector	Screwless connectors

Wall-mount speaker

CB 200W

4W wood enclosure wall-mount speaker

- Excellent sound quality
- Easy to install
- Durable
- Multi tapping available with volume control

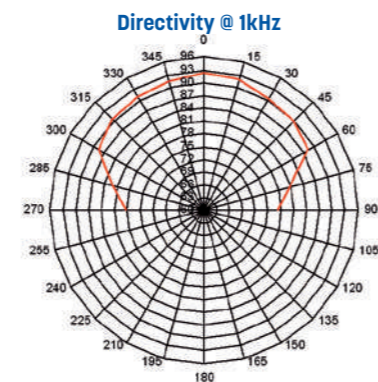
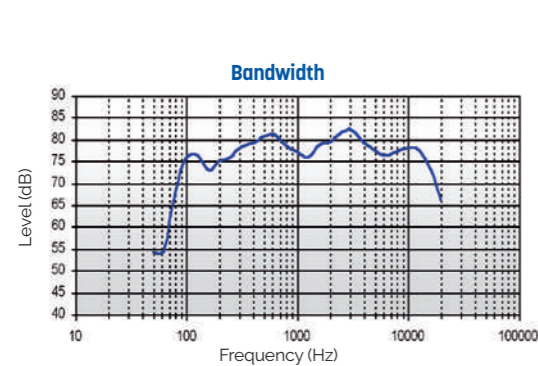

Model	CB 200W
Speaker	1 way - bicone
Body & grill	Wood / Fabric
Nominal power	4W
100V line power	0,125/0,25/0,5/1/2/4W
Bandwidth	100 to 15,000Hz
Sensitivity 1W / 1m	93dB
Directivity @ 1kHz	100°
Dimensions (WxHxD)	250 x 200 x 88mm
Weight	1.83kg

Wall-mount speaker

CB 56T VA

6W Wall mount Speaker

EN 54 24

- The 6W powered speaker is equipped with a 165mm full-range loudspeaker and a 100V transformer with 3 power adjustments 6/3/1.5W.
- The high-density, shock-resistant MDF wood housing in white provides a low resonance sound. A sturdy front grille made of steel guarantees enduring stability.
- For additional reliability, a 2 pin-ceramic block, a thermal fuse is provided and the speaker chassis is impregnated against wetness.
- The speaker is also secured with the high protection class IP54 against the security risks of environmental influences.
- The proven spring clamp on the rear plate ensures a quick mounting on walls.

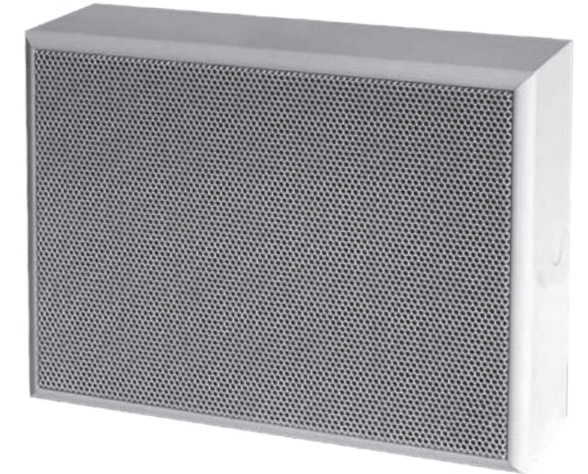

Model	CB 56T VA
Body & grill	MDF, Steel
Nominal power	6W
Nominal Impedance	1,667Ω
Power 100V Line	6 / 3 / 1,5W
Impedance	1,667 / 3,333 / 6,667Ω
Bandwidth	197 - 21 900Hz
Sensitivity (1W/1m)	93dB
SPL MAX 1m	100.8dB
Directivity (H-V) @ 500Hz	180°
Directivity (H-V) @ 1kHz	160°
Directivity (H-V) @ 2kHz	125°
Directivity (H-V) @ 4kHz	89°
Speaker	5"
Cone	Paper
Dimensions (WxHxD)	254 x 195 x 81mm
Weight	1,95kg
Operating temperature	-10 to +55°C
Protection Index	IP54
Color	White

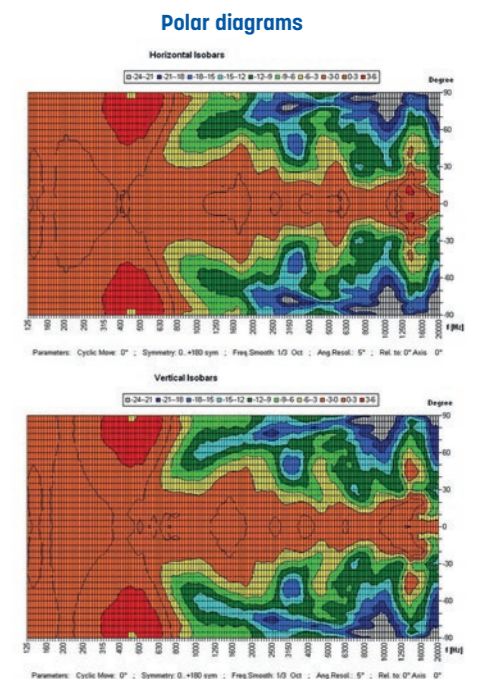
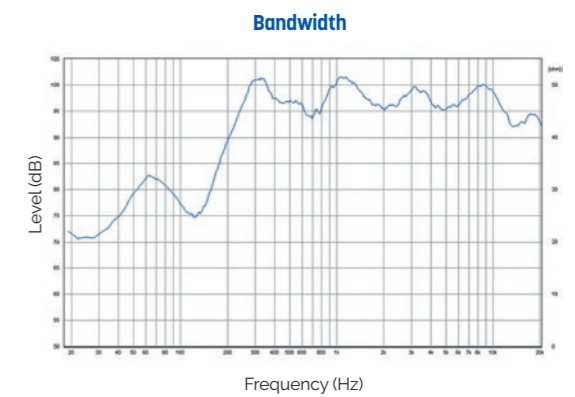

Wall-mount speakers

BB 202T - BB 202TB

2-way Wall mount Speakers - 15W/100V - 20W/8Ω

- These Hi-Fi quality 2-way wall speakers are appropriate for broadcasting music and voice in small and medium-sized installations: reception halls, restaurants, pubs, meeting rooms, shopping malls...
- They are equipped with a swiveling fastener, clip-type terminals and a 100V line or 8Ω power selector.



BB 202T (White)

BB 202TB (Black)

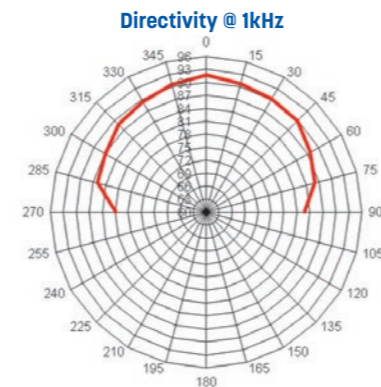
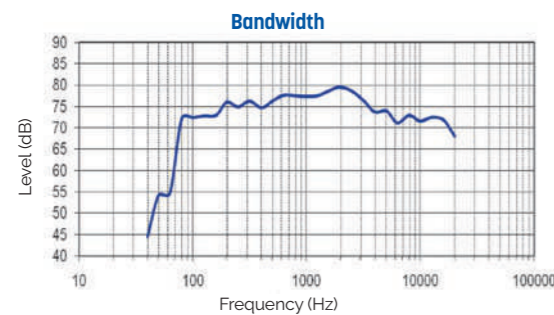

Model	BB 202T / BB 202TB
Speaker	4" + tweeter
Body & grill	ABS / Metal
Nominal power	15W
Peak power	30W
100V line power	5/7/15W · 20W 8Ω
Bandwidth	80 to 18,000Hz
Sensitivity 1W / 1m	88dB
Directivity @ 1kHz	110°
Dimensions (WxHxD)	130 x 190 x 115mm
Weight	1,7kg

Wall-mount speakers

BB 501W - BB 501B

2-way Wall mount Speakers - 30W - 100V - 8Ω



BB 501W (White)

BB 501B (Black)

- These Hi-Fi quality 2-way wall speakers are appropriate for broadcasting music and voice in small and medium-sized installations: reception halls, restaurants, pubs, meeting rooms, shopping malls...

- They are equipped with a swiveling fastener, clip-type terminals and a 100V line or 8Ω power selector.
- They can be installed both indoors and outdoors.

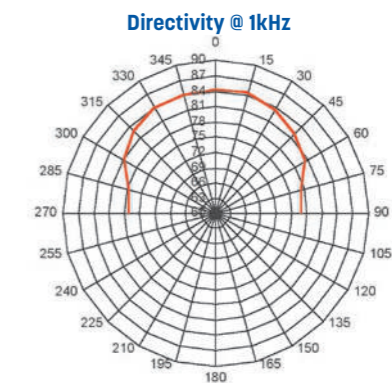
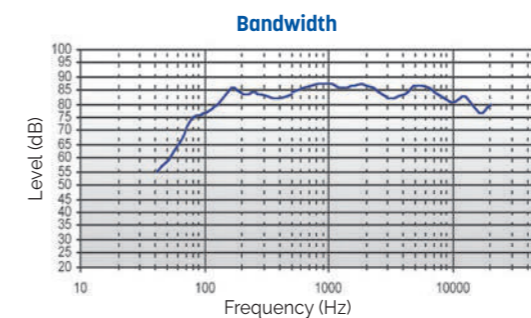

Model	BB 501W / BB 501B
Speaker	5" - Plastic Diaphragm + tweeter
Body & grill	ABS / Aluminium
Nominal power	30W
Peak power	45W
100V line power	5/10/20/30W · 8Ω
Bandwidth	63 to 20,000Hz
Sensitivity 1W / 1m	91dB
Directivity @ 1kHz	95° H x 165° V
Dimensions (WxHxD) (mm)	155 x 261 x 170/200 with bracket
Weight	1,7kg

Wall-mount speakers

MS 530TB VA - MS 530TW VA

2-way Wall mount Speakers - 30W EN 54 24

- The MS Serie compact wall speakers impress by a sophisticated design and by its powerful sound.
- Perfectly suitable for installations where high sound quality is needed..
- The 30W powered speaker is equipped with a high quality 2-way system and a 100V transformer with 3 power adjustments.
- The impact-resistant, UV-resistant ABS plastic housing assures enduring stability.
- For additional reliability, a thermal fuse and a wetness impregnation of the speaker is provided.
- The speaker is also secured with protection class IP 65 against the risks of environmental influences.



MS 530TB VA (Black)



MS 530TW VA (White)

Polar diagrams

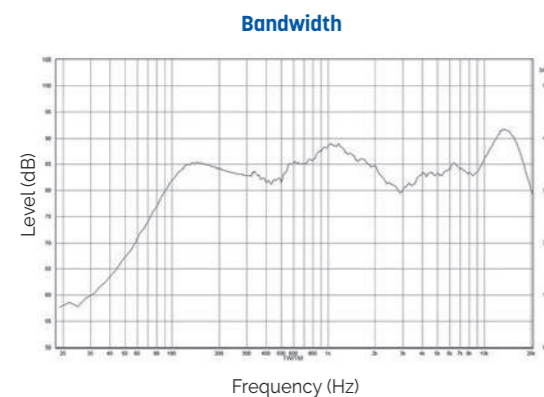
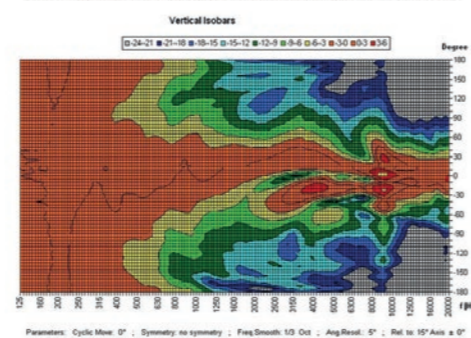
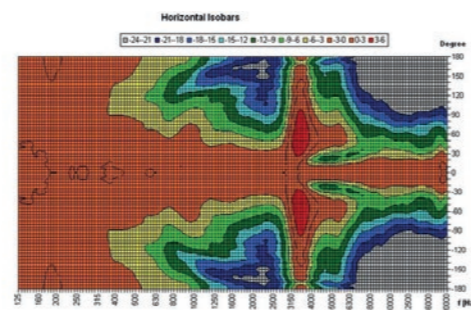

Wall-mount speakers

MS 650TB VA - MS 650TW VA

2-way Wall mount Speakers - 50W EN 54 24

- The MS Serie compact wall speakers impress by a sophisticated design and by its powerful sound.
- Perfectly suitable for installations where high sound quality is needed..
- The 30W powered speaker is equipped with a high quality 2-way system and a 100V transformer with 3 power adjustments.
- The impact-resistant, UV-resistant ABS plastic housing assures enduring stability.
- For additional reliability, a thermal fuse and a wetness impregnation of the speaker is provided.
- The speaker is also secured with protection class IP 65 against the risks of environmental influences.



MS 650TB VA (Black)



MS 650TW VA (White)

Polar diagrams

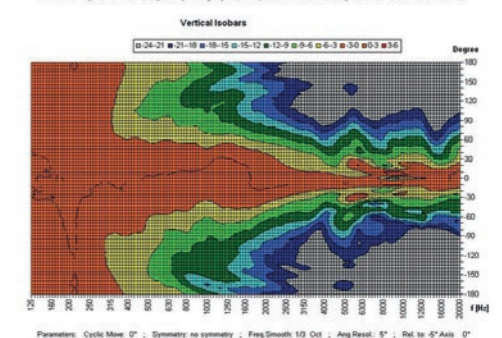
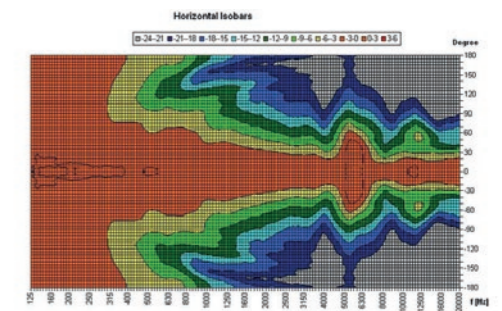

Model	MS 650TB VA - MS 650TW VA
Body & grill	ABS
Nominal power	50W
Nominal Impedance	200Ω
Power 100V Line	50 / 25 / 12,5 / 6,25W
Impedance	200 / 400 / 800 / 1 600Ω
Bandwidth	52 - 25,000Hz
Sensitivity (1W/1m)	88,8dB
SPL MAX 1m	105,1dB
Directivity (H-V) @ 500Hz	360° x 360°
Directivity (H-V) @ 1kHz	200° x 155°
Directivity (H-V) @ 2kHz	110° x 120°
Directivity (H-V) @ 4kHz	80° x 25°
Speaker	6"
Dimensions (WxHxD)	205 x 330 x 192 mm
Weight	3,65kg
Operating temperature	-25°C ~+70°C
Protection Index	IP 65 - IK 09
Color	MS 650TB VA: Black / MS 650TW VA: White

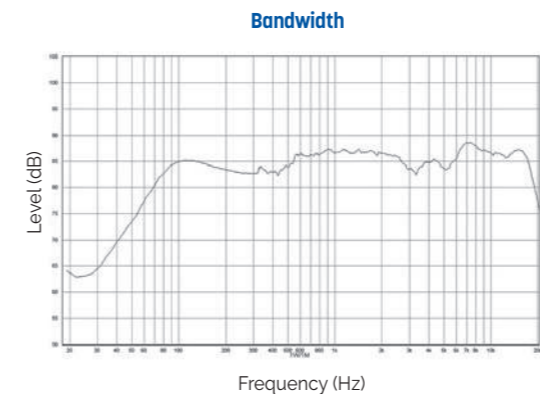

Wall-mount speakers

WS-15T/W-30T/W-50T/W- 80T/W

Indoor/outdoor compact wall mount speakers 15-30-50-80W - 8Ω - white

WS-15T/B-30T/B- 50T/B- 80T/B

WS-15/W-30T/W- 50T/W- 80T/W black editions



- WS Series is the Installation Speaker which is weather resistant and it also brightens the venue with its elegant design. The speakers can be used in various applications from small-sized venues to mid/large-sized venues. To be specific, it particularly fits in facilities that high quality of background music is playing a crucial role (cafes and hotel lobby etc.), educational facilities (auditorium and conference room etc.) and cultural facilities (exhibition hall etc.)
- WS Series is composed of 4 models from 2.5" Full-Range unit installed compact-sized WS-15T to 6.5" 2way model WS-80T.
- The Series has been applied with newly developed Full-Range unit, HF driver and LF driver unit to provide high-power clear sound without distortion. Moreover, 2way model adopts asymmetric horn design to over audience area perfectly.
- With the speaker taps on the rear panel of the every WS Series model, 100V line/70V line and low impedance (8Ω) output can be adjusted.
- WS Series has obtained IP rate of 54 which enables to be used in various indoor and outdoor applications.



Model	WS-15T	WS-30T	WS-50T	WS-80T	
Type	2.5" 1 way full range	4" 2 way passive	5" 2 way passive	6.5" 2 way passive	
Enclosure Material	ABS RESIN				
Power	Continuous (AES Std)	15W	30W	50W	80W
	Program:+3dB	30W	60W	100W	160W
	Peak: +6dB	60W	120W	200W	320W
Nominal Impedance	8Ω				
Frequency Range (-10dB)	110Hz-20,000Hz	100Hz -20,000Hz			
Sensitivity 1W / 1m (dB)	84dB	85dB	87dB	90dB	
Maximum SPL	102dB	106dB	110dB	115dB	
Directivity (1kHz)	90°	Horizontal: 120° (Near Field) , 60° (Far Field) Vertical: +20° to -40° (on axis)			
Transformer Taps	70V	15/10/5/3W	30/15/7.5/3.8/1.9W	50/25/13/6.5/3.3W	80/40/20/10/5W
	100V	15/10/5/3W	30/15/7.5/3.8W	50/25/13/6.5W	80/40/20/10/5W
Connectors	2P screw terminal				
Dimensions (WxHxD)	92 x 120 x 114mm	139 x 210 x 129mm	173 x 250 x 150mm	210 x 311 x 169mm	
Weight	0.9kg	1.72kg	2.37kg	3.57kg	
IP Rating	IP54				

High definition speaker

MS-80LT

2-Way Passive Compact Loudspeaker - 80W

MSB-80

U Bracket (optional)

- The MS-80LT is a compact full-range 2-way loudspeaker. Its woofer comes from the famous Italian acoustic manufacturer Fital PRO to offer you increased audio quality.
- It is designed for music broadcasting and voice reproduction for commercial applications such as shops, restaurants, hotels, reception areas and meeting rooms.
- It integrates a titanium high-frequency transducer with protection circuitry in a perfectly balanced package with excellent audio performance.
- Absorbing sound box made of very robust and environmentally friendly eucalyptus.
- Secure and recessed housing to ANSI standards.



Model	MS-80LT	
Type	5" 2-Way Passive High Impedance	
Enclosure Material	15mm Eucalyptus	
Power Rating	Continuous (AES Std)	80W
	Program:+3dB	160W
	Peak: +6dB	320W
Nominal Impedance	8Ω	
Frequency Response (-10dB)	60Hz-20kHz	
Sensitivity (1 m/1 W) (dB)	88dB	
SPL Max	113dB	
Directivity (1kHz)	120° Conical	
Transformer Taps (70V/100V)	Low Impedance: 8Ω High Impedance : 62Ω (70V), 125Ω ,250Ω, 500Ω, 1kΩ, 2kΩ (100V)	
Recommended High-Pass Filter	60Hz 12dB/Oct.	
LF Driver	5" Woofer (FitalPRO)	
HF Driver	1.35" Soft Dome Tweeter Titanium(CIC ADA) driver	
Connectors	Screw Type Terminal	
Fittings	MSB-80 Optional - U bracket - 3x M6 (6mm)	
Dimensions (WxHxD)	152x250x209.5mm	
Weight	3.8kg	

AS-630R

Set of 2 speakers (1 active + 1 passive)
2 x 30W



- AS-630R speakers set includes a 6" driver and a 1.5" tweeter.
- The integrated amplification provide a power of 2x30W. She had 2 audio inputs for all OdB audio signal allow you to connect for example one video projector a mixing console.
- The provided infra-red remote control allow you to control most of setting for an easier use.
- The RS-232 port allow management of the speaker from an automation device.
- This pair of speakers is perfectly suited to the following applications: class room, meeting room, projection room, in addition of television.

Model	ASR-630R
Input power	2 x 30W @ 8Ω
Input sensitivity	0.350V
Frequency response	80Hz - 16kHz/1W, ±3dB
THD	1kHz/1W, 0.1%
S/N ratio	85dB
Channel Isolation	> 65dB
Amplification style	D class
Indicating type	Power / Signal
Protection type	Over temperature protection, overload protection, mute switch
Bass adjustment	±10dB
Treble adjustment	±10dB
Input type	Euroblock balance, stereo 3.5mm jack
RS232	Euroblock RS232 Input
VCA	Euroblock VCA Input
Remote control	Infra-red Remote control
Power source	~110V-240V 50/60Hz
Dimensions (WxHxD)	216 x 295 x 245mm
Weight	6.5kg (pair)

IMPI 120T

1-way indoor/outdoor sound projector - 10W

- Standard quality sound projector equipped with a 100V line transformer, 2.5/5/10W.
- Can be used indoors or outdoors.

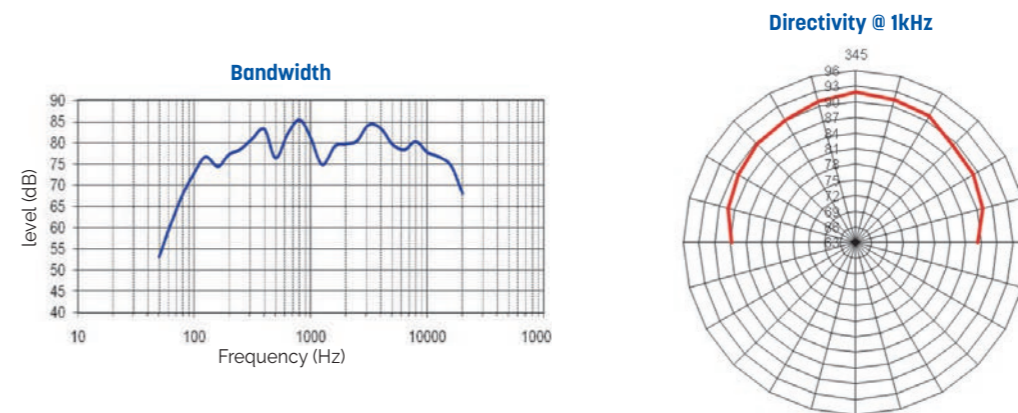

Model	IMPI 120T
Speaker	5"
Body & grill	ABS / Metal
Nominal power	10W
100V line power	2.5/5/10W
Bandwidth	130 to 15,000Hz
Sensitivity 1W / 1m	91dB
Directivity @ 1kHz	90°
Dimensions (Ø x L)	138 x 205mm
Weight	1.6kg
Protection rating	IP55

Sound projector

IMPI 330T

1-way indoor/outdoor sound projector - 10W

- Aluminium sound projector recommended for all types of indoor or outdoor public places
- Equipped with a 5" speaker, their extended frequency response allows it to broadcast either music or voice messages.

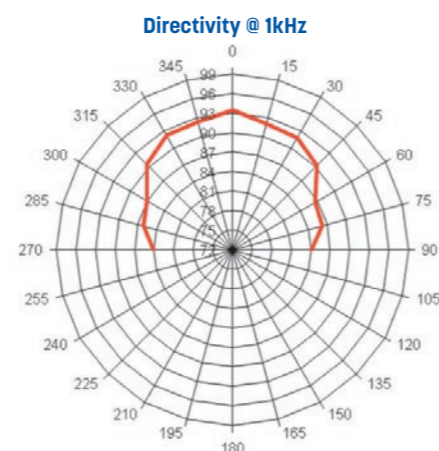
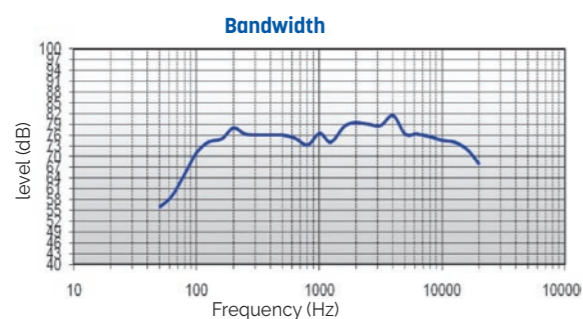

Model	IMPI 330T
Speaker	5"
Body & grill	Aluminium
Nominal power	10W
100V line power	2.5/5/10W
Bandwidth	130 to 15,000Hz
Sensitivity 1W / 1m	91dB
Directivity @ 1kHz	90°
Dimensions (Ø x L)	138 x 225mm
Weight	2.15kg
Protection rating	IP55

Sound projector

IMPI 330T VA

10W Indoor/outdoor sound projector

EN 54 24



Compliant with the international standards relative to public address and evacuation installations (EN 54-24 Type B and ISO 7240-24), this sound projector is recommended for the equipment of all types of public places such as train stations, pedestrian streets, car parks etc.

QUALITY SPEECH AND MUSIC REPRODUCTION

Equipped with a 12cm diameter loudspeaker, its frequency response makes it possible to broadcast high-quality music and information messages.

EASY TO INSTALL

A solid aluminium bracket is provided to facilitate the installation and orientation of the projector in almost all positions. It is possible to mount the bracket first and then the sound projector.

WITHSTANDS ALL KINDS OF WEATHER

Made of extruded aluminium, it can be installed indoors or outdoors (IP55) and blends in with most surroundings.

- Optional specific RAL painting available : **PEINT PROJECTEUR** (minimum 15 pcs).

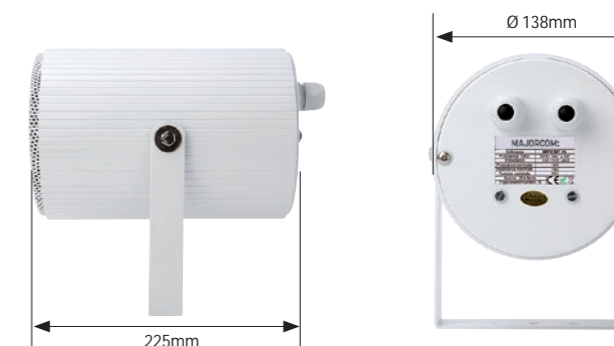

Model	IMPI 330T VA
Body & grill	Aluminium
Nominal power	10W
Nominal Impedance	1kΩ
Power 100V Line	10 / 5 / 2.5W
Impedance	1 / 2 / 4kΩ
Bandwidth	120Hz - 20kHz
Sensitivity (1W/1m)	95dB
SPL MAX 1m	103dB
Directivity (H-V) @ 500Hz	360° - 360°
Directivity (H-V) @ 1kHz	240° - 260°
Directivity (H-V) @ 2kHz	115° - 115°
Directivity (H-V) @ 4kHz	54° - 54°
Speaker	5"
Cone	Plastic
Dimensions [mm]	Ø138 x (D)225
Weight	2.5kg
Operating temperature	-25 to +70°C
Protection Index	IP55
Color	White

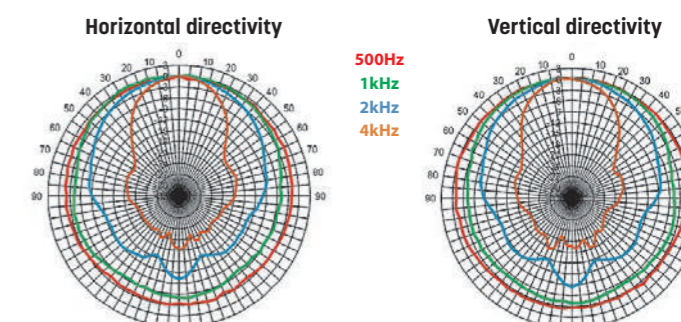
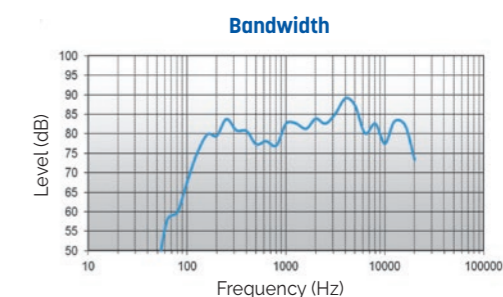

Sound projector

SPOT2010-EN5424 20W sound projector

EN 54 24



- High intelligibility
- Protection index IP 55
- Inconspicuous & multipurpose
- Easy and quick installation
- The SPOT2010-EN5424 is a 20W sound projector fitted with a dual cone loudspeaker.
- Its fixing device facilitates its orientation and ensures an easy and quick installation : wall- or ceiling mounting.
- Made out of ABS, it is weatherproof, shock and corrosion resistant. Therefore, it can be installed in any type of environment

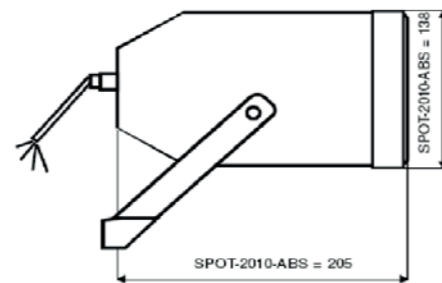
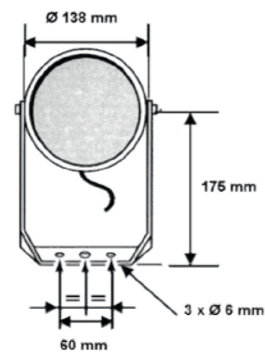

Model	SPOT2010-EN5424
Nominal power	20 W
Power 100V Line	20 / 10 / 5 W
Frequency range	110 - 17 000 Hz
Impedance	20 W : 0,5 kΩ / 10 W : 1 kΩ / 5 W : 1,8 kΩ
Sensitivity (1W/1m)	100 dB
SPL Max 1m	112 dB / 20W
Directivity (-6dB)	500 Hz : 180° 4 KHz : 75°
Speaker	Ø 12,5 cm dual cone
Dimensions	Ø 138 x 205 mm
Fixed centre distance	2 x 60 mm
Weight	1,6 kg
Material	ABS + Alu grid
Protection rating	IP55
Color	White
Connexion	Block terminals

Sound projector

IMPI 520T VA 20W Design Sound Projector

EN 54 24

- The 20W design speaker with an amazing concave shape is equipped with a 130mm full-range speaker and a 100V transformer with 3 power adjustments 20/10/5W.
- Acoustically the design loudspeaker convinces at all levels. Thanks to a smart phase-shifting and a high-quality midrange resonator, the speaker offers a sound characteristic that is matching a 2-way system.
- In addition, the very wide dispersion ensures a comprehensive sound.
- A robust, ABS plastic housing in RAL9016 and a stable aluminium mounting bracket guarantee a durable installation.
- The cable is fed via a cable gland (PG11).The integrated 2x2-pole ceramic block and thermal fuse as well as the moisture impregnation of the loudspeaker ensure additional safety.

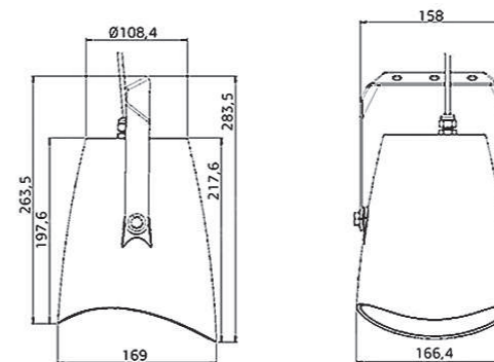

Model	IMPI 520T VA
Body & grill	ABS, Aluminium
Nominal power	20W
Nominal Impedance	500Ω
Power 100V Line	20 / 10 / 5W
Impedance	500 / 1.000 / 2.000Ω
Bandwidth	142 - 14 300Hz
Sensitivity (1W/1m)	88,4dB
SPL MAX 1m	100dB
Directivity (H-V) @ 500Hz	360°
Directivity (H-V) @ 1kHz	155° - 220°
Directivity (H-V) @ 2kHz	95° - 85°
Directivity (H-V) @ 4kHz	80° - 85°
Speaker	5"
Cone	PP polypropylene
Dimensions (WxDxH)	166,4 x 283,5 x 169mm
Weight	1,76kg
Operating temperature	-25 to +70°C
Protection Index	IP65
Color	RAL 9016

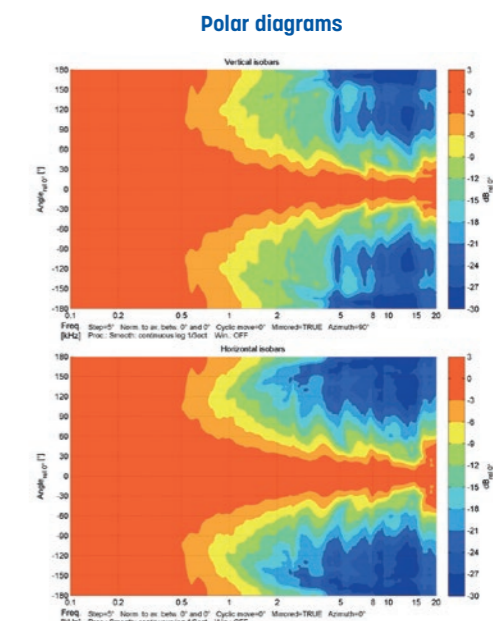
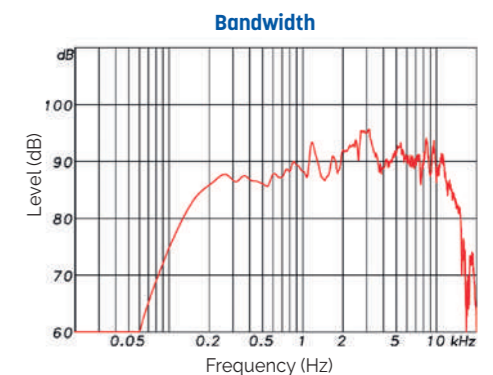

Bi-directional sound projector

IMPI 2510T VA

10W bi-directional sound projector EN 54 24

- The 10W powered speaker is equipped with two 130mm full-range loudspeakers and a 100V line transformer with 4 power adjustments.
- A robust powder coated aluminum housing in RAL 9010, and a vandal-resistant feet ensure a permanent installation of this speaker.
- For additional reliability, a 2x2 pin-ceramic block and a thermal fuse is provided and the speaker chassis is impregnated against wetness.
- Optional specific RAL painting available : **PEINT DUAL** (minimum 25 pcs).

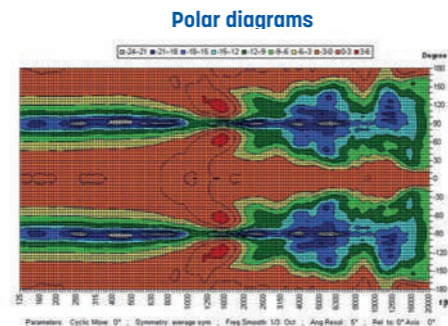
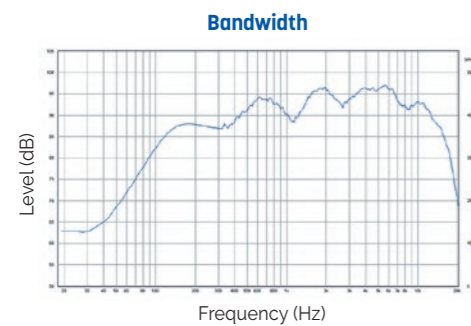

Model	IMPI 2510T VA
Body & grill	Aluminium
Nominal power	10W
Nominal Impedance	1.000Ω
Power 100V Line	10 / 6 / 3 / 1.5W
Impedance	1.000 / 1.667 / 3.333 / 6.667Ω
Bandwidth	237 - 12 400Hz
Sensitivity (1W/1m)	89,6dB
SPL MAX 1m	95,3dB
Directivity (H-V) @ 500Hz	2 x 130°
Directivity (H-V) @ 1kHz	2 x 150°
Directivity (H-V) @ 2kHz	2 x 145°
Directivity (H-V) @ 4kHz	2 x 75°
Speaker	2 x 5"
Cone	Coated paper
Dimensions (WxDxH)	197 x 161 x 166mm
Weight	2,35kg
Operating temperature	-25 to +70°C
Protection Index	IP65
Color	RAL 9010

Bi-directional sound projector

SPJ-52WHBS

2-way bi-directional sound projector - 20W EN 54 24

- Excellent reproduction of voice and music
- Built-in connector and connection cables
- For installation on the ceiling or on the wall
- Protection from water and dust, IP66
- The SPJ-52WHBS is a powerful, 20-W bidirectional sound projector designed for the high-quality reproduction of voice and music.
- It can be used inside or outside. The two opposing speakers are perfect for applications such as metro stations, train stations, parking garages, and make it possible to cut the number of speakers in half.
- The SPJ-52WHBS is equipped with a ceramic terminal block, a thermal fuse and wires that can withstand high temperatures.



Model	SPJ-52WHBS
Body & grill	Aluminium
Nominal power	20W
Nominal Impedance	500Ω
Power 100V Line	20 / 10 / 5W
Impedance	500 / 1.000 / 2.000Ω
Bandwidth	120Hz - 20,000Hz
Sensitivity (1W/1m)	88dB
SPL MAX 1m	100dB
Directivity (H-V) @ 500Hz	360°
Directivity (H-V) @ 1kHz	320°
Directivity (H-V) @ 2kHz	200°
Directivity (H-V) @ 4kHz	80°
Speaker	2 x 5"
Cone	Paper composite
Dimensions	Ø 146 x 186mm
Weight	3,2kg
Operating temperature	-20 to +70°C
Protection Index	IP66

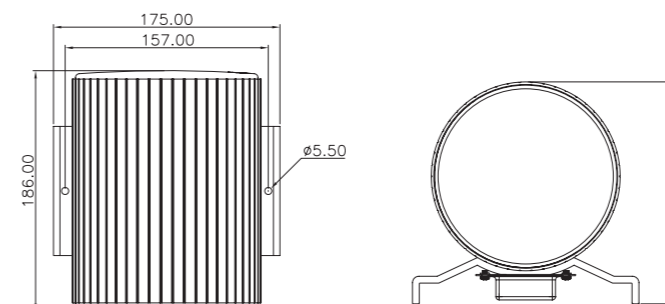
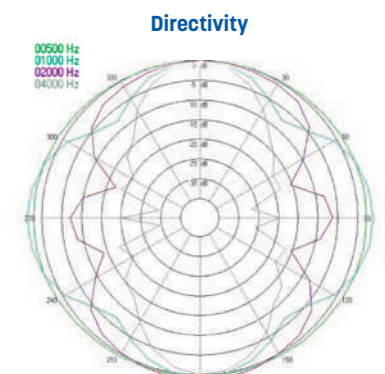
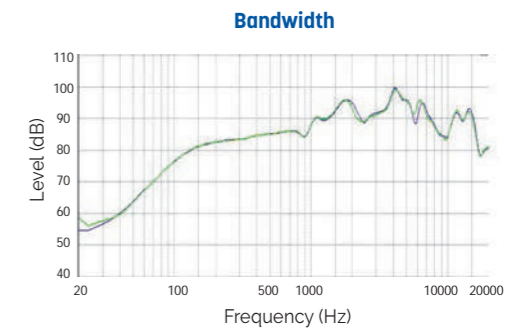

Spherical speaker

B 150T

10W spherical speaker

- Spherical loudspeaker designed for use in public areas, shops, halls, supermarkets...
- It is equipped with a bicone 5" speaker and a 100V line transformer.
- This loudspeaker designed to be suspended includes a 1m cable and a safety steel rope.

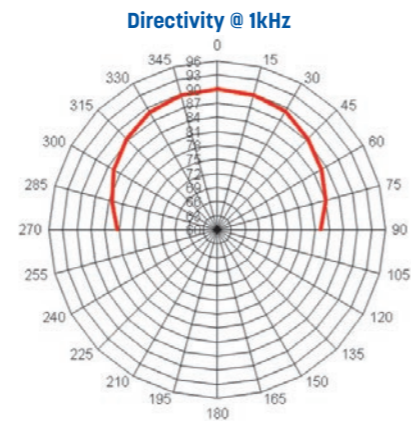
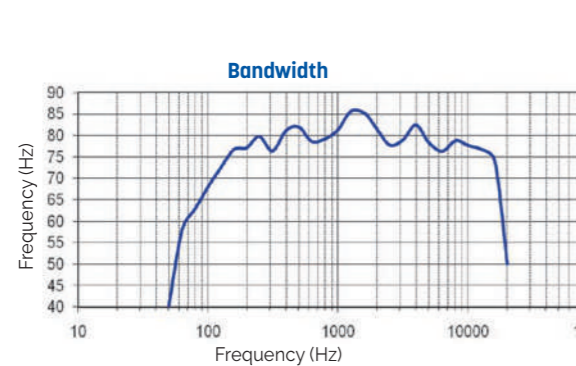

Model	B 150T
Speaker	5"
Body & grill	ABS
Nominal power	10W
100V line power	2.5/5/10W
Bandwidth	150 to 15,000Hz
Sensitivity 1W / 1m	92dB
Directivity @ 1kHz	90°
Dimensions (Ø)	180mm
Weight	1,350kg

Spherical speaker

B 250T EN

2-way spherical speaker - 15W

- Spherical loudspeaker designed for use in public areas, shops, halls, supermarkets...
- It is equipped with two speakers, a 6.5" midrange transducer and a coaxial tweeter, which provide excellent acoustic quality.
- Suspended from a ceiling using a safety cable.
- Optional specific RAL painting available : **PEINT SPHERE** (minimum 12 pcs).

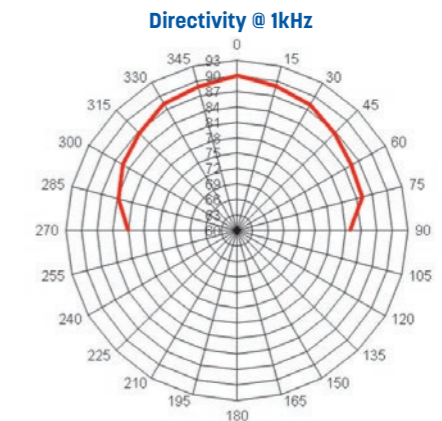
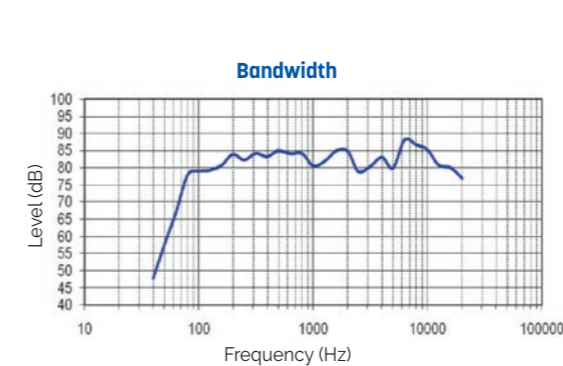

Model	B 250T EN
Speaker	6.5" - 2-way
Body & grill	ABS
Nominal power	15W
100V line power	5/7/15W
Bandwidth	75 to 20,000Hz
Sensitivity 1W / 1m	91dB
Directivity @ 1kHz	90°
Dimensions (Ø)	250mm
Weight	1,6kg
EN standard	60849

Pendant speakers

B 420TW VA - B 420TB VA

20W Design Pendant Speakers EN 54 24

- The 20W pendant speaker is equipped with a 100mm 2-way bass reflex system and offers powerful sound with a wide and homogeneous dispersion.
- The B 420T VA has a 100V transformer with 4 power adjustments, these can be easily adjusted by a rotary switch on the top of the sphere. Low impedance operation is also possible.
- The impact-resistant, UV-resistant ABS plastic housing guarantees lasting stability.
- Additional operational safety is provided by the 2x2-pole ceramic terminal block, a thermal fuse, a PG screw connection integrated into the canopy and the moisture impregnation of the loudspeaker.
- The loudspeaker is protected against the risks of environmental influences with protection class IP65.



B 420TW VA (White)

B 420TB VA (Black)

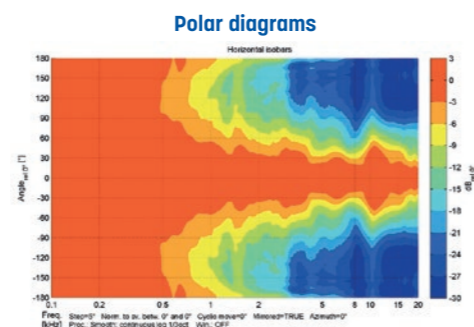
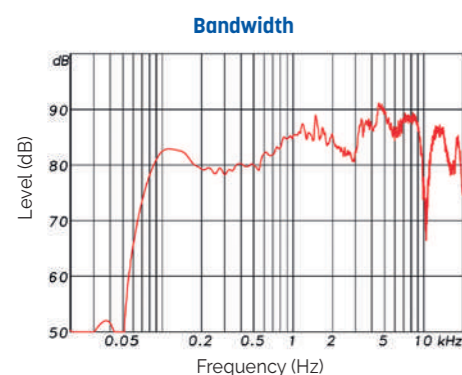

Model	B 420TW VA - B 420TB VA
Body & grill	ABS, Aluminium
Nominal power	20W
Nominal Impedance	500Ω
Power 100V Line	20 / 10 / 5 / 2,5W
Impedance	500 / 1,000 / 2,000 / 4,000Ω
Bandwidth	70 - 22,000Hz
Sensitivity (1W/1m)	83.9dB
SPL MAX 1m	96.9dB
Directivity (H-V) @ 500Hz	360°
Directivity (H-V) @ 1kHz	160°
Directivity (H-V) @ 2kHz	102°
Directivity (H-V) @ 4kHz	86°
Speaker	4"
Cone	PP polypropylene
Dimensions	Ø 189,4 x H 231mm
Weight	2,02kg
Operating temperature	-10 to +55°C
Protection Index	IP65
Color	B 420TW VA : White / B 420TB VA : Black

Pendant speakers

PEND-3025B-EN

30W Pendant Speaker EN 54 24

- Very good sound coverage : broadcast angle > 150°
- Dynamic sound : 5" full range driver
- Discrete and smooth design : aerodynamic shape, black matt
- Easy and quick installation : cable with carabiners, Euroblock terminal & potentiometer
- This black pendant loudspeaker is composed of a 5" full range driver which guarantees a very good intelligibility of both your safety messages and your background music.
- It is ideal for spaces with high ceiling.
- Its installation remains easy with its Euroblock connector and its strong cable supplied with carabiners.

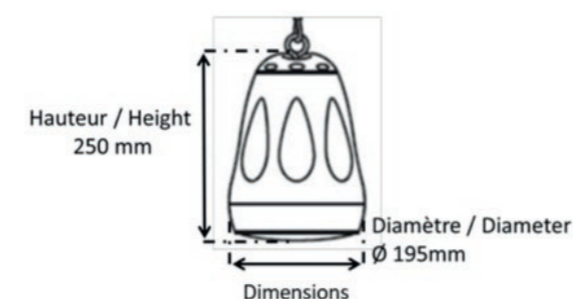

Model	PENDING-3025B-EN
Nominal power	30 W
Impedance	30 W : 333 Ω / 15 W : 666 Ω / 7,5 W : 1333 Ω / 3,8 W : 2630 Ω
Power 100V Line	30 / 15 / 7,5 / 3,8 W + 8 Ω (adjustable with potentiometer)
Bandwidth	110 Hz - 20 kHz
Sensitivity (1W/1m)	85 dB
SPL MAX 1m	98 dB
Speaker	5" full range driver
Directivity (H-V) @ 500 Hz	360°
Directivity (H-V) @ 1 kHz	146.5°
Directivity (H-V) @ 2 kHz	82.5°
Directivity (H-V) @ 4 kHz	76.5°
Dimensions	Ø 195 x H 250 mm
Weight	2,2 kg
Operating temperature	-10°C à +55°C
Material	ABS
Protection Index	IP21 (resistant to humidity)
Color	Black
Accessories	Fixation cable + carabiners

Pendant speakers

B 652T-W - B 652T-B 2-way pendant speakers 32W



Connector and hook system



B 652T-W

B 652T-B

- These ultra-design pendant speakers are recommended for installation without ceiling where a high-quality broadcasting is required. They blend in with all lighting equipment on the current market.
- Their coaxial 2-way 6.5" woofer with silk dome make outstanding speakers adapted for intelligible music and voice reproduction.

- Ideally suited for restaurant such facilities, shop mall, medium sized surfaces, they are available on black or white for a perfect integration.
- They are provided with a safety rope GRIPPLE® type, ceramic terminal and cover with rubber cable gland.

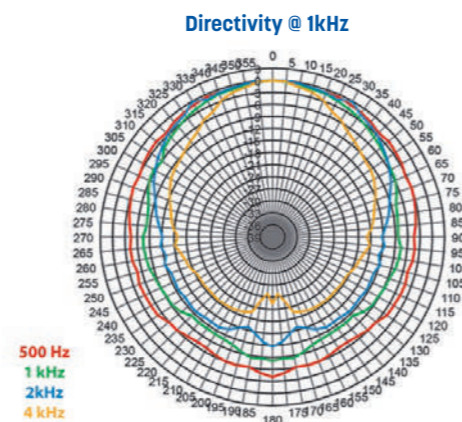
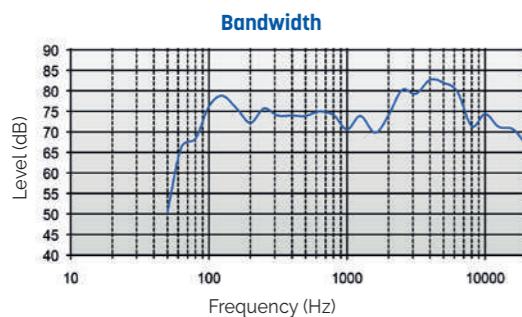

Model	B 652T-W / B 652T-B
Connector aSpeaker	2-way 6.5" coaxial
Material	ABS fibreglass reinforced / Aluminium
Colour	White: B 625T-W / Black: B 652T-B
Nominal Impedance	16Ω
Nominal power	32W
100V line power	4 / 8 / 16 / 32W
Bandwidth	80 to 22,000Hz
Sensibility 1W / 1m	90dB
SPL max	105dB
Crossover frequency	3kHz
Terminal	10mm ² ceramic terminal
Dimensions (ØxH)	256 x 315mm
Weight	3.2kg
Regulation	UL 1480 UEAY, UL 2239, CE, RoHS

Column speaker

CU-440F 40W indoor column speaker

- This column speaker intended for indoor use is specially designed for places with difficult acoustics such as churches, halls, etc.
- With its rotary power selector, this column provides an effective solution to the intelligibility of the spoken message.
- Its wall mounting bracket offers the possibility of optimizing its orientation.



Directivity @ 1kHz

Bandwidth

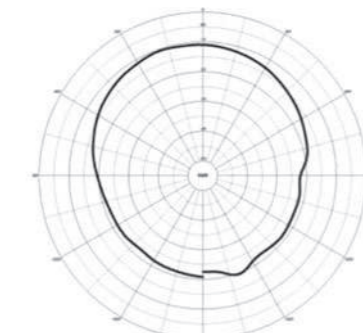
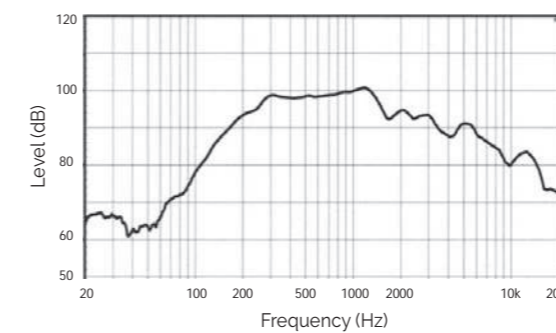

horizontal

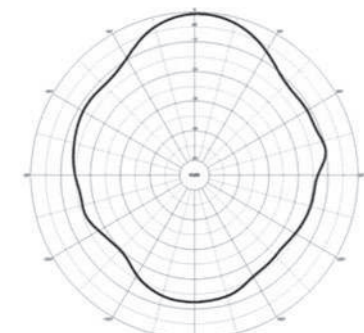

vertical

Model	CU-440F
Body	Body, top & bottom Cover: ABS
Grill	Metal
Driver	4"
Nominal power	40W
Power 100V Line	20/40W
Impedance	250/500Ω
Bandwidth (-10dB)	135Hz ~ 13,700Hz
Sensitivity (1W/1m/1KHz)	92dB
SPL Max	108dB
Directivity HxV (1KHz)	195° x 52°
Directivity HxV (4KHz)	112° x 15°
Dimensions (WxHxD)	156 x 600 x 129mm
Weight	4.76kg
Certification	KS
Accessory	Wall mounting bracket included

Column speaker

CU-9030

30W Outdoor 2-Way Column Speaker

- The CU-9030 is a high-performance column speaker specialized in demanding environments.
- It is equipped with a high-performance speaker driver that enables clear voice transmission from a distance.
- It is designed to be durable with a waterproof and dust-proof design (IP65), an aluminium body and a galvanized steel grille.
- Therefore, it can be applied to special facilities such as brine, port facilities that need to cope with corrosion, and factories that require dust prevention.
- Its fixing bracket offers the possibility to optimize the orientation.

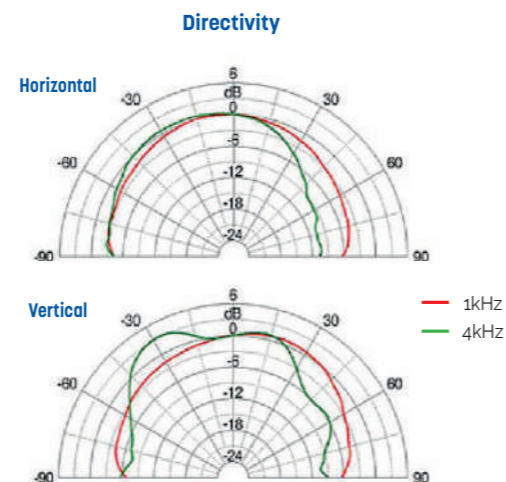
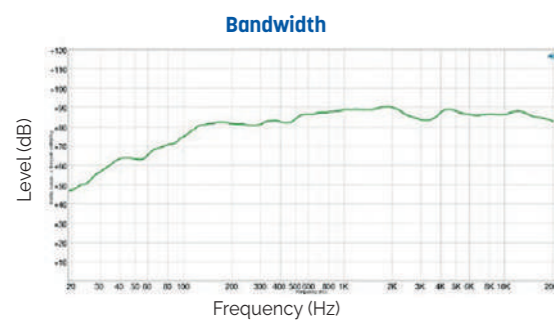
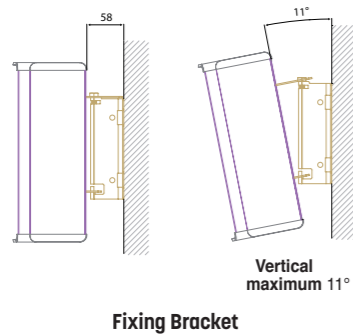

Model	CU-9030
Enclosure and grill material	Aluminium / Zn-plating
Nominal power	30W
Power 100V line	30/15W
Impedance	330/660Ω
Frequency Range (-10dB)	15Hz ~ 20kHz
Sensitivity (1W/1m, 1kHz)	88dB
SPL Max	106dB
Directivity HxV (1KHz)	180° / 175°
Directivity HxV (4KHz)	130° / 110°
Dimensions (WxHxD)	160 x 320 x 125mm
Weight	3.09kg
Weather Resistance	IP65

Column speaker

CU-9060

60W Outdoor 2-Way Column Speaker

- The CU-9060 is a high-performance column speaker specialized in demanding environments.
- It is equipped with a high-performance speaker driver that enables clear voice transmission from a distance.
- It is designed to be durable with a waterproof and dust-proof design (IP65), an aluminium body and a galvanized steel grille.
- Therefore, it can be applied to special facilities such as brine, port facilities that need to cope with corrosion, and factories that require dust prevention.
- Its fixing bracket offers the possibility to optimize the orientation.

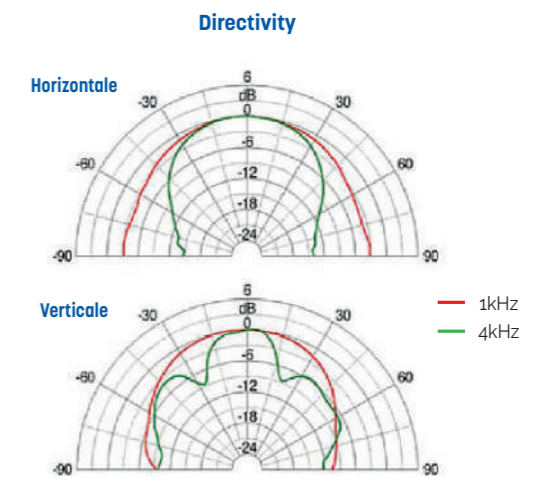
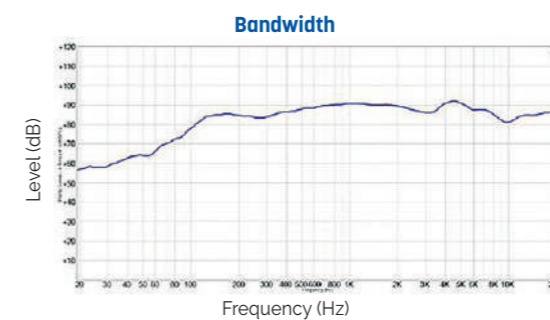
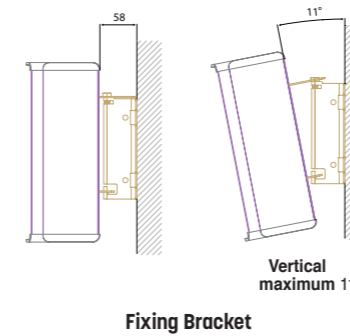

Model	CU-9060
Enclosure and grill material	Aluminium / Zn-plating
Nominal power	60W
Power 100V line	60/30W
Impedance	166/330Ω
Frequency Range (-10dB)	105Hz ~ 20kHz
Sensitivity (1W/1m, 1kHz)	90dB
SPL Max	110dB
Directivity HxV (1KHz)	180° / 90°
Directivity HxV (4KHz)	120° / 40°
Dimensions (WxHxD)	160 x 450 x 125mm
Weight	4.66kg
Weather Resistance	IP65

Column speaker

CU 320T VA 20W Sound Column

EN 54 24

- The 20W powered speaker is equipped with four 77mm full-range loudspeaker chassis and a 100V transformer with 4 power adjustments.
- The powder coated and shock-resistant aluminium housing in RAL 9006 guarantees long-term stability.
- For additional reliability, a 2 pin-ceramic block, a thermal fuse is provided and the speaker chassis is impregnated against wetness.
- Furthermore sturdy cable glands 2 x PG9 are also provided.
- The speaker is also secured with the high protection class IP66 against the security risks of environmental influences
- Optional specific RAL painting available : **PEINT CU** (minimum 25 pcs).

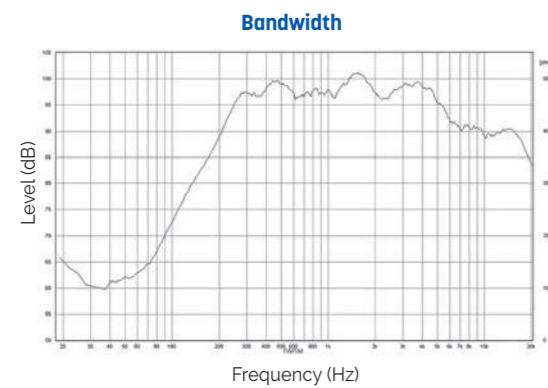

Model	CU 320T VA
Body & grill	Aluminium
Nominal power	20W
Nominal Impedance	500Ω
Power 100V Line	20 / 15 / 10 / 5W
Impedance	500 / 667 / 1,000 / 2,000Ω
Bandwidth	147 - 23 500Hz
Sensitivity (1W/1m)	92.5dB
SPL MAX 1m	100.3dB
Directivity (H-V) @ 500Hz	360° - 124°
Directivity (H-V) @ 1kHz	188° - 65°
Directivity (H-V) @ 2kHz	149° - 38°
Directivity (H-V) @ 4kHz	86° - 14°
Speaker	4 x 3"
Dimensions (WxHxD)	510 x 100 x 92 mm
Weight	2.9kg
Operating temperature	-25°C ~+70°C
Protection Index	IP66 - IK 08
Color	RAL 9006

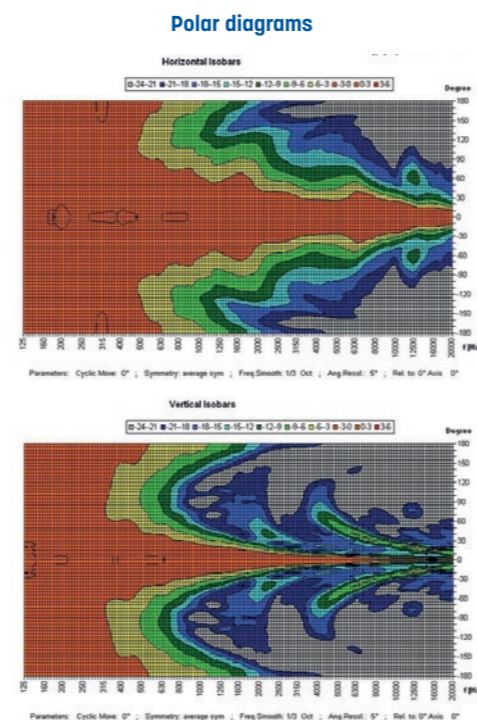

Column speaker

CU 350T VA 50W Sound Column

EN 54 24

- The 50W powered speaker is equipped with eight 77mm full-range loudspeaker chassis and a 100V transformer with 4 power adjustments.
- The powder coated and shock-resistant aluminium housing in RAL 9006 guarantees long-term stability.
- For additional reliability, a 2 pin-ceramic block, a thermal fuse is provided and the speaker chassis is impregnated against wetness.
- Furthermore sturdy cable glands 2 x PG9 are also provided.
- The speaker is also secured with the high protection class IP66 against the security risks of environmental influences.
- Optional specific RAL painting available : **PEINT CU** (minimum 25 pcs).

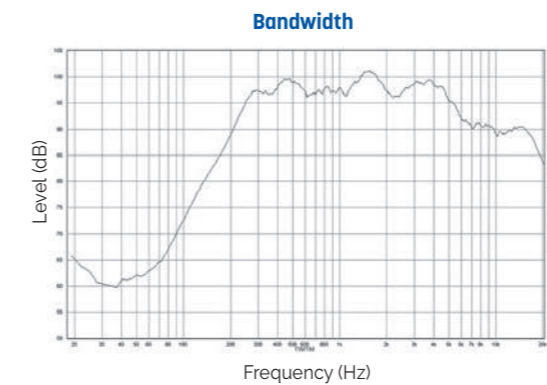

Model	CU 350T VA
Body & grill	Aluminium
Nominal power	50W
Nominal Impedance	200Ω
Power 100V Line	50 / 30 / 15 / 7.5W
Impedance	200 / 333 / 667 / 1,333Ω
Bandwidth	110 - 18,000Hz
Sensitivity (1W/1m)	94.7dB
SPL MAX 1m	102.8dB
Directivity (H-V) @ 500Hz	360° - 73°
Directivity (H-V) @ 1kHz	186° - 33°
Directivity (H-V) @ 2kHz	173° - 17°
Directivity (H-V) @ 4kHz	98° - 6°
Speaker	8 x 3"
Dimensions (WxHxD)	100 x 971 x 92mm
Weight	5.2kg
Operating temperature	-25°C ~+70°C
Protection Index	IP66 - IK 08
Color	RAL 9006

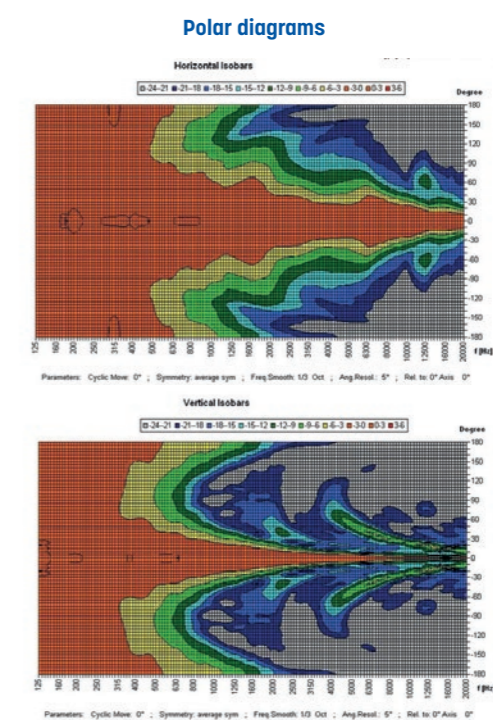

Column speakers

CU-7060-B - CU-7060-W

Dual 4" 2-way indoor column speakers 60W - 8Ω

- The CU-7060 are indoor column speakers specialized for places where rich sound pressure and high quality music reproduction are required.
- Designed to minimize driver-to-driver interference, they deliver clear and rich sound with high-frequency and low-loss professional-quality audio.
- They are suitable for indoor space such as churches, halls, restaurants, etc.

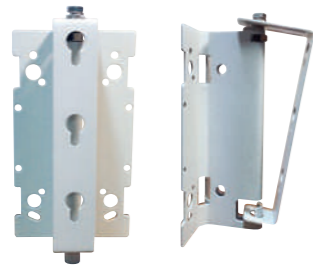

Fixing bracket



CU-7060-B

CU-7060-W

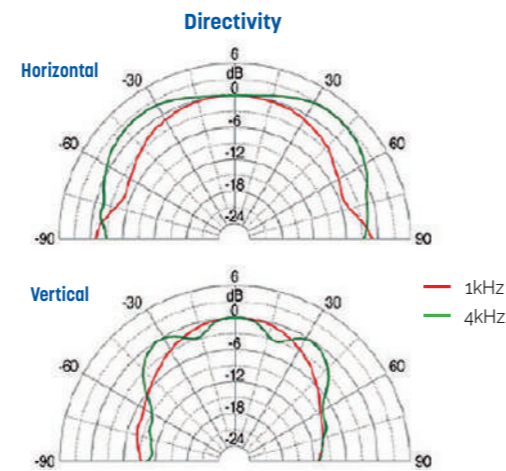
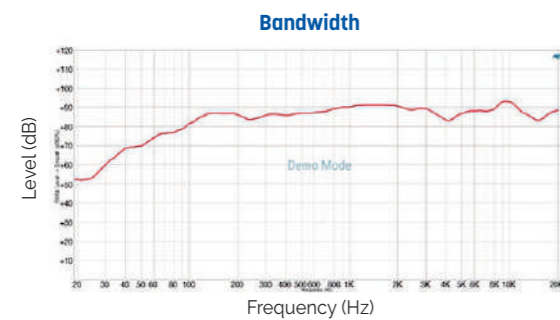

Model	CU-7060-B	CU-7060-W
Type	Dual 4" 2-way column speaker	
Body & grill	MDF/Metal	
Color	Black	White
Nominal power	60W	
100V line power	30W - 330Ω / 60W - 166Ω / 60W - 8Ω	
Bandwidth (-10dB)	100 to 20,000Hz	
Sensitivity (1 m/1 W, 1 kHz)	92dB	
SPL Max	111dB	
Directivity	1kHz	140° horizontal x 100° vertical
	4kHz	180° horizontal x 106° vertical
Connectors	4P Screw Terminal	
Dimensions (WxHxD)	130 x 420 x 195mm	
Weight (kg)	5.42kg	
Accessorie provided	Fixing bracket	

Column speakers

CU-7120-B - CU-7120-W

Dual 4" 2-way indoor column speakers 120W - 8Ω

- The CU-7120 are indoor column speakers specialized for places where rich sound pressure and high quality music reproduction are required.
- Designed to minimize driver-to-driver interference, they deliver clear and rich sound with high-frequency and low-loss professional-quality audio.
- They are suitable for indoor space such as churches, halls, restaurants, etc.

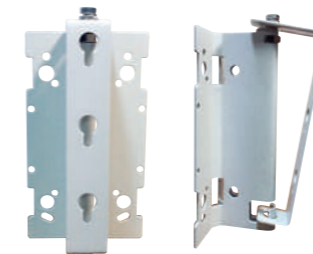

Fixing bracket



CU-7120-B

CU-7120-W

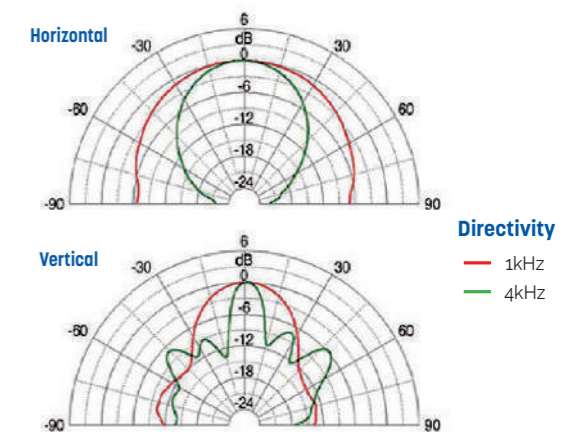
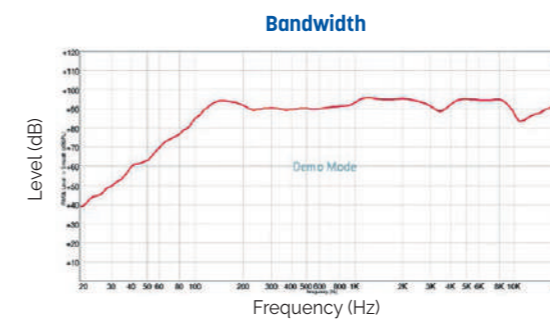

Model	CU-7120-B	CU-7120-W
Type	Dual 4" 2-way column speaker	
Body & grill	MDF/Metal	
Color	Black	White
Nominal power (W)	120W	
100V line power	60W - 166Ω / 120W - 83Ω / 120W - 8Ω	
Bandwidth (-10dB)	95 to 20,000Hz	
Sensitivity (1 m/1 W, 1 kHz)	94dB	
SPL Max	116dB	
Directivity	1kHz	150° horizontal x 50° vertical
	4kHz	70° horizontal x 20° vertical
Connectors	4P Screw Terminal	
Dimensions (WxHxD)	130 x 620 x 195mm	
Weight (kg)	8.02kg	
Accessorie provided	Fixing bracket	

M-RC-COMPACT-02 40W compact speaker

- Compact speaker – 40 W
- Moisture resistant- IP 32
- High intelligibility
- Superior acoustic quality
- Easy and quick installation
- Unique design

- The M-RC-Compact-02 is an aluminium 40W speaker.
- Its ellipsoid shape makes it possible to reduce diffraction phenomena and to homogenize the acoustic radiation, thus keeping a high opening angle up to 4000 Hz. This feature ensures wider coverage of the audience area over the whole speech dedicated frequency band.
- With its unique design and its acoustical performances, it is adapted to all environments.
- Its ball-type fixing device facilitates its orientation and ensures simple and rapid installation.
- Optional specific RAL painting available : **PEINT COMPACT** (minimum 25 pcs).

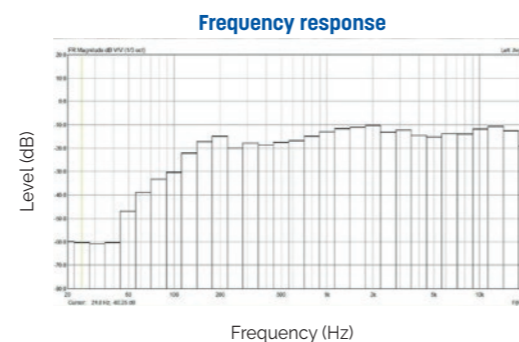

Model	M-RC-COMPACT-02
Nominal power	40 W
Frequency range	100Hz – 20kHz
Impedance	250 Ω
SPL (1W/1m)	89 dB
SPL max	107 dB
Directivity [-6dB]	160°
Color	Aluminium grey RAL 9006
Material	Aluminium, metal grid
Dimensions	139 x 160 x 280 mm
Weight	3.4 kg
Protection Index	IP32
Acoustic load	Bass reflex
Accessory	Kneecap mount included

CH-420 20W High efficiency sound projector

CH-430 30W High efficiency sound projector

- Excellent durability and clarity by adopting a synthetic resin structure
- Indoor and outdoor use with water repellent treatment
- Structure that can be easily attached to the wall by adjusting the orientation angle to 240° vertically and 135° to the left and right
- IP54

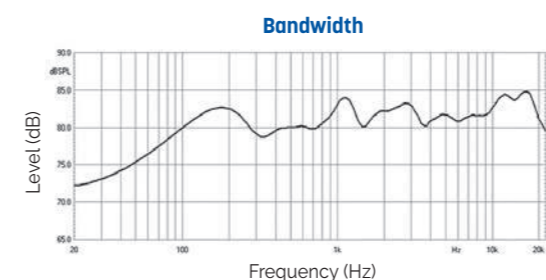

Model	CH-420	CH-430
Type	4" Horn Speaker	
Input Power 100V	20/10W	30/15W
Impedance 100V	500Ω/1kΩ	330/660Ω
Frequency Response [-10dB]	110Hz - 12,000Hz	110Hz - 20,000Hz
Frequency Range [-20%]	100Hz - 18,000Hz	90Hz - 20,000Hz
Sensitivity (1W/1m, 1kHz)	93dB	94dB
SPL max [Cont]	106dB	109dB
Nominal Dispersion (conical)	1kHz	110° x 180°
	4kHz	50° x 30°
Dimensions (WxHxD)	291 x 154 x 364mm	
Weight	3.4kg	3.5kg
Weather Resistance	IP54	

High efficiency sound projector

CS 532T VA

2-Way Horn Speaker - 30W EN 54 24

- The 30W powered 2-way speaker is equipped with a 100V line transformer with 4 power adjustments 30/15/7.5/3.75W.
- The impact-resistant ABS housing in RAL 7035 guarantees long-term stability.
- For additional reliability, a ceramic block and a thermal fuse is provided.
- The speaker is also secured with the high protection class IP66 against the security risks of environmental influences. Mounting by stainless aluminum universal mount.



Bandwidth

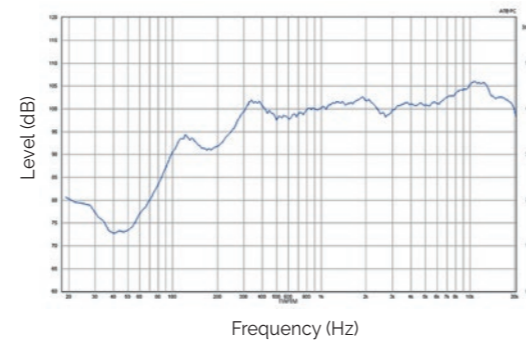

Polar diagrams

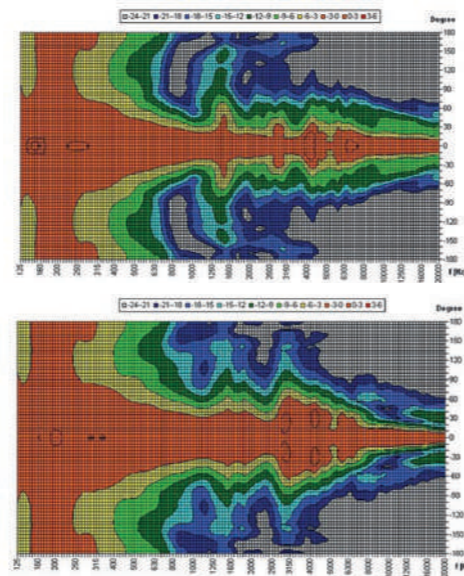

Model	CS 532T VA
Body & grill	ABS
Nominal power	100W
Nominal Impedance	100Ω
Power 100V Line	100 / 50 / 25W
Impedance	100 / 200 / 400Ω
Bandwidth	280 to 9,000Hz
Sensitivity (1W/1m)	98.1dB
SPL MAX 1m	112dB
Directivity (H-V) @ 500Hz	58° - 35°
Directivity (H-V) @ 1kHz	35° - 25°
Directivity (H-V) @ 2kHz	40° - 20°
Directivity (H-V) @ 4kHz	54° - 15°
Speaker	5" + Driver
Dimensions (WxDxH)	315 x 305 x 350mm
Weight	16kg
Operating temperature	-25 to +70°C
Protection Index	IP66
Color	White
Couleur	RAL 9016

High efficiency sound projector

CS-5HTBS

2-Way Horn Speaker - 30W EN 54 24

- The CS-5HTBS long-range enclosure is equipped with a 2-way system, thereby providing a wide frequency range and high sensitivity, making it ideal for the high-quality reproduction of voice and music..
- With its controlled-directivity acoustical horn and two transducers, one for low frequencies and the other for high, this unique rectangular enclosure produces amazingly pure sound..
- The horn is waterproof and can be used in high-humidity environments. It is therefore suitable for outdoor use such as sports fields, stadiums, theme parks, exhibition halls and air terminals, as well as for applications used in P.A and evacuation systems.



Bandwidth

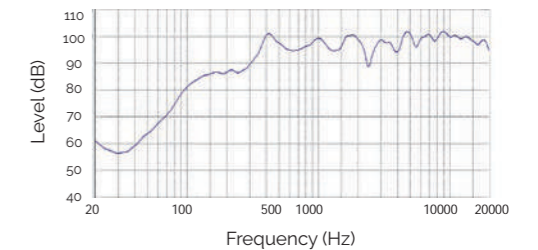

Horizontal directivity

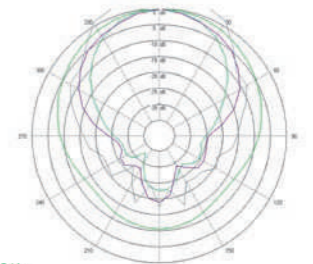

Vertical directivity

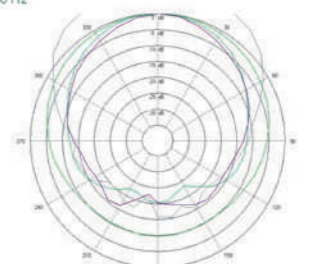

Model	CS-5HTBS
Body & grill	ABS fireproof
Nominal power	30W
Nominal Impedance	333Ω
Power 100V Line	30 / 15 / 7.5 / 3.75W
Impedance	333 / 666 / 1,333 / 2,667Ω
Bandwidth	120Hz - 20,000Hz
Sensitivity (1W/1m)	96dB
SPL MAX 1m	111dB
Directivity (H-V) @ 500Hz	140° - 180°
Directivity (H-V) @ 1kHz	60° - 100°
Directivity (H-V) @ 2kHz	90° - 90°
Directivity (H-V) @ 4kHz	90° - 140°
Speaker	6" + 2.5" driver
Dimensions (WxDxH)	315 x 355 x 215mm
Weight	4.65kg
Operating temperature	-25 to +70°C
Protection Index	IP66
Color	White

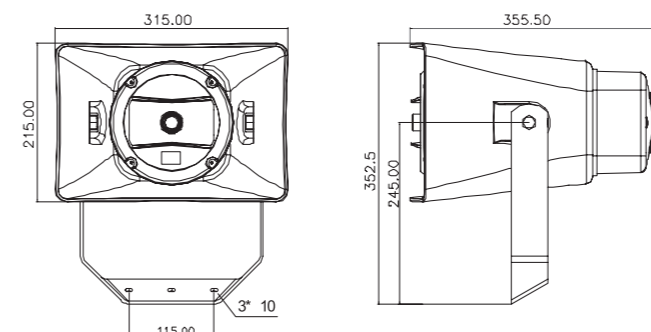

High efficiency sound projector

CS-6HT60BS

2-Way Horn Speaker - 60W

EN 54 24

- The CS-5HTBS long-range enclosure is equipped with a 2-way system, thereby providing a wide frequency range and high sensitivity, making it ideal for the high-quality reproduction of voice and music..
- With its controlled-directivity acoustical horn and two transducers, one for low frequencies and the other for high, this unique rectangular enclosure produces amazingly pure sound..
- The horn is waterproof and can be used in high-humidity environments. It is therefore suitable for outdoor use such as sports fields, stadiums, theme parks, exhibition halls and air terminals, as well as for applications used in P.A and evacuation systems.

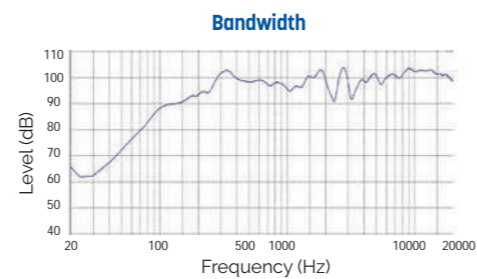

Horizontal directivity

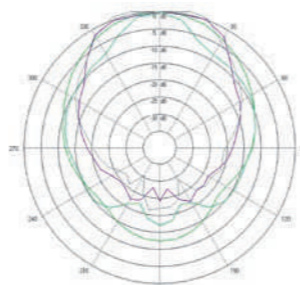

Vertical directivity

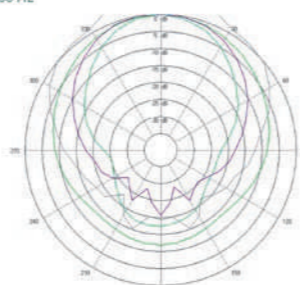

00500 Hz
01000 Hz
02000 Hz
04000 Hz

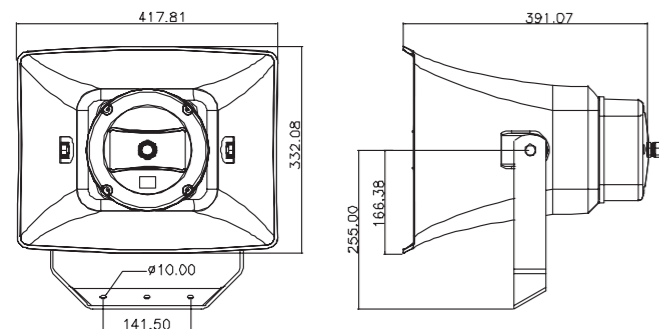

Horn speaker

PHS-81T30BS

30W Horn Speaker

EN 54 24

- High performance enclosure
- High-quality vocal reproduction
- Protection from water and dust, IP66
- The high-performance horn speaker faithfully reproduces speech with excellent sound distribution and can be used in a wide range of outdoor applications. The perfect solution for sports fields, parks, factories and outdoor pools
- The speaker is equipped with a ceramic terminal block, a thermal fuse and wires that can withstand high temperatures.
- Included is a U-shaped, stainless steel universal mount and screws (both AISI 316) for flexible installation.



Model	PHS-81T30BS
Body & grill	ABS fireproof
Nominal power	30W
Nominal Impedance	333Ω
Power 100V Line	30 / 15 / 7.5 / 3.75W
Impedance	333 / 666 / 1,333 / 2,667Ω
Bandwidth	340Hz - gkHz
Sensitivity (1W/1m)	108dB
SPL MAX 1m	123dB
Directivity (H-V) @ 500Hz	200°
Directivity (H-V) @ 1kHz	120°
Directivity (H-V) @ 2kHz	60°
Directivity (H-V) @ 4kHz	30°
Dimensions [mm]	Ø212 x 280
Weight	2,05kg
Operating temperature	-25 to +70°C
Protection Index	IP66
Color	White

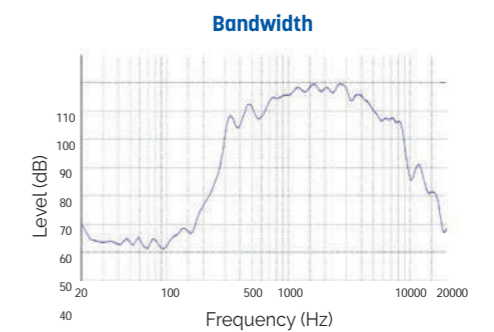

Directivity

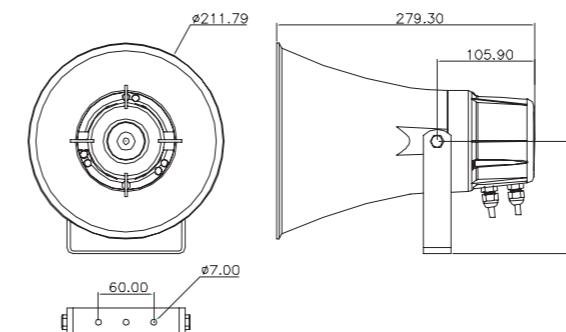
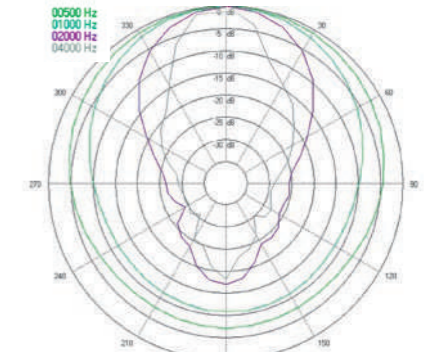

Horn speaker

HS-50

50W High efficiency outdoor metal horn speaker

- This horn speaker allows high level sound distribution indoor or outdoor.
- It is specially recommended for outdoor public address such as camping sites, beaches, ski resorts... and particularly indicated for noisy industrial environments.
- It is UV and water resistant.

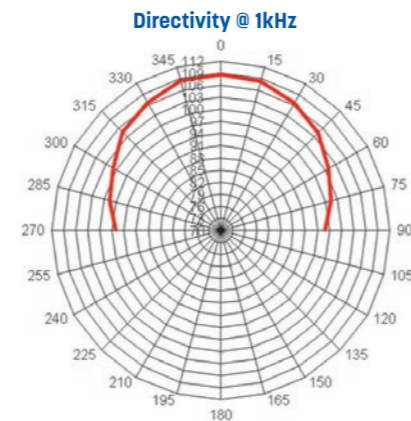
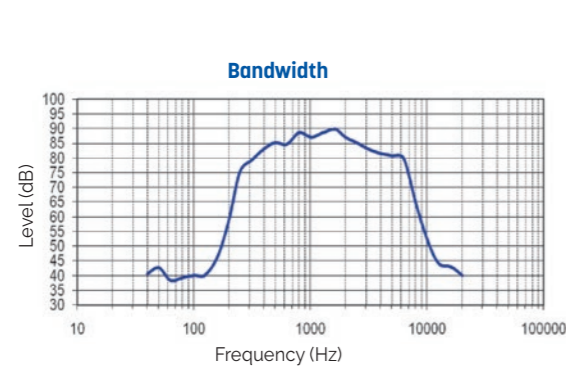

Model	HS-50
Material	Painted aluminium
Nominal power	50W
Peak power	55W
100V line power	25W / 400Ω 50W / 200Ω · 8Ω
Bandwidth (Hz)	380 to 6,500Hz
Sensitivity 1W / 1m	108dB
Directivity @ 1kHz	60°
Dimensions	320 x 350mm
Weight	3
Protection Index	IP66

Horn speaker

TU 100T VA

100W Horn speaker

EN 54 24

- The boundary horn speaker TU 100T VA has been developed for areas with extreme high ambient noise and is suitable for indoor and outdoor application, such as tunnels.
- It is built to withstand corrosive atmospheric contaminants, high moisture levels and temperature extremes. The horn provides an enormous sound pressure level, a very balanced frequency response and also a very low distortion.
- The TU 100T VA with a flame retardant plastic housing (UL 94 V-0) in black and IP 65 protection is also equipped with a ceramic terminal and thermal fuse. The high quality 100W horn driver offers a high performance CCAR voice coil. Furthermore sturdy cable glands 2 x PG13,5 are also provided.
- Sturdy installation by rust-free V4A (A4) stainless steel brackets and screws.
- This horn speaker provides intelligible voice notifications over great distance, resulting in a lower number of loudspeakers which are required. The product is a certified voice alarm speaker according EN 54-24 and there is no additional equalizer needed to meet the frequency response requirements according EN 54-24.

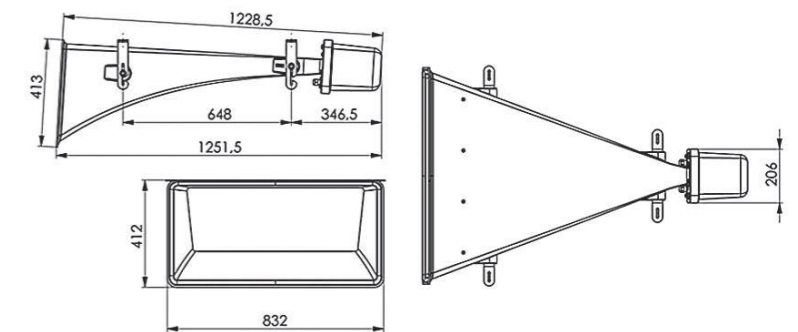
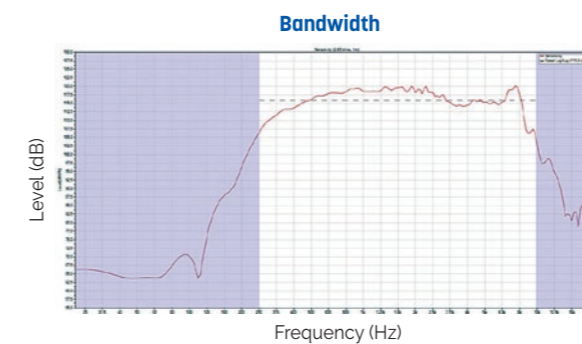

Polar diagrams

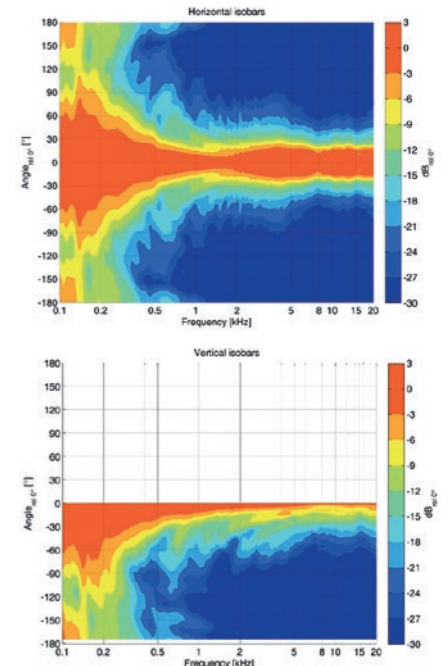

Model	TU 100T VA
Material	ABS
Nominal power	100W
Nominal Impedance	100Ω
Power 100V Line	100 / 50 / 25W
Impedance	100 / 200 / 400Ω
Bandwidth	280 to 9,000Hz
Sensitivity (1W/1m)	113,9dB
SPL MAX 1m	131,9dB
Directivity (H-V) @ 500Hz	58° - 35°
Directivity (H-V) @ 1kHz	35° - 25°
Directivity (H-V) @ 2kHz	40° - 20°
Directivity (H-V) @ 4kHz	54° - 15°
Dimensions (WxDxH)	315 x 305 x 350mm
Weight	16kg
Operating temperature	-25 to +70°C
Protection Index	IP65

Power loudspeaker

PS 8150T/W VA - PS 8150T/B VA
2-Way Horn Speakers - 150W

EN 54 24

- This 2-way coaxial horn speaker is designed for booth outdoor and outdoor applications !
- EN 54-24 certified, it delivers a superb foreground music.
- The PS 8150T VA delivers a smooth and powerful beam type sound for a large range of venues, such as airports, mega-stores, stadiums and many more.
- The 150W powered professional speaker is equipped with an impressive 2-way bassreflex system, consisting of an 8" woofer and a high performance HF-driver with crossover at 2.5kHz.
- The speaker offers 3 different 100V power tapings 150/75/38W, low impedance operation is also possible.
- The sturdy high-impact ABS housing in white with metal hexagon-shaped aluminium grille offers IP66 enclosure protection.
- Connection is easily done by a screw-terminal at the rear of the speaker, protected by a cover plate with 2 x PG11 cable glands.
- The metal mounting bracket with adjustable inclination enables simple and safe installation. A safety rope is included in the delivery.



PS 8150T/W VA (White)



PS 8150T/B VA (Black)

Bandwidth

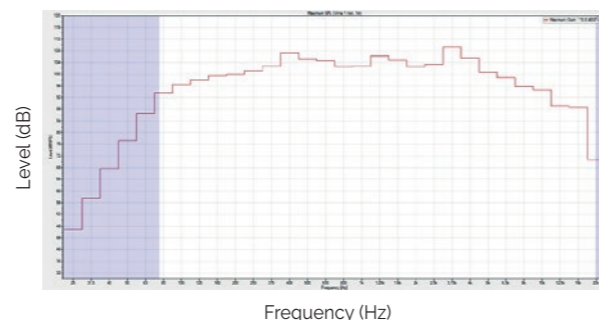

Polar diagrams

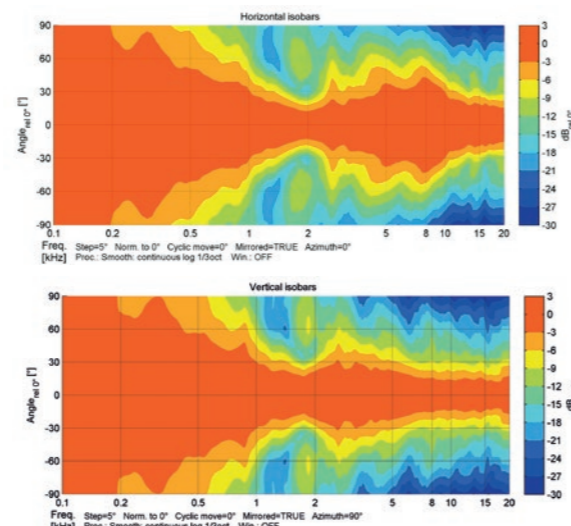

Model	PS 8150T/W VA - PS 8150T/B VA
Body & grill	ABS, Aluminium
Nominal power	150W
Nominal Impedance	67Ω
Power 100V Line	150 / 75 / 38W
Impedance	67 / 133 / 263Ω
Bandwidth	75 - 20,000Hz
Sensitivity (1W/1m)	96,7dB
SPL MAX 1m	116.8dB
Directivity (H-V) @ 500Hz	170° - 180°
Directivity (H-V) @ 1kHz	79° - 80°
Directivity (H-V) @ 2kHz	50° - 62°
Directivity (H-V) @ 4kHz	85° - 70°
Speaker	8" + Driver
Cone	PP polypropylene
Dimensions (WxHxD)	315 x 305 x 350mm
Weight	11,85kg
Operating temperature	-25 to +70°C
Protection Index	IP66

Power loudspeaker

PS 8250T/W VA - PS 8250T/B VA
2-Way Horn Speakers - 250W

EN 54 24

NEW

- This 2-way coaxial horn speaker is designed for booth outdoor and outdoor applications !
- EN 54-24 certified, it delivers a superb foreground music.
- The PS 8250T VA delivers a smooth and powerful beam type sound for a large range of venues, such as airports, mega-stores, stadiums and many more.
- The 250W powered professional speaker is equipped with an impressive 2-way bassreflex system, consisting of a 12" woofer and a high performance HF-driver with crossover at 2.5kHz.
- The speaker offers 3 different 100V power tapings 250/125/63W, low impedance operation is also possible.
- The sturdy high-impact ABS housing with metal hexagon-shaped aluminium grille offers IP66 enclosure protection.
- Connection is easily done by a screw-terminal at the rear of the speaker, protected by a cover plate with 2 x PG11 cable glands.
- The metal mounting bracket with adjustable inclination enables simple and safe installation. A safety rope is included in the delivery.



PS 8250T/W VA (White)



PS 8250T/B VA (Black)

Bandwidth

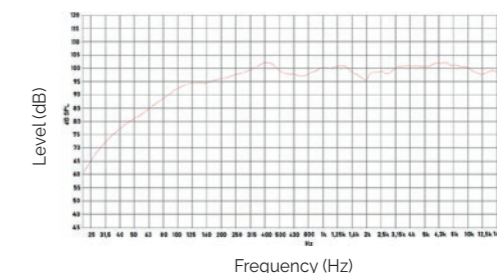

Polar Diagrams

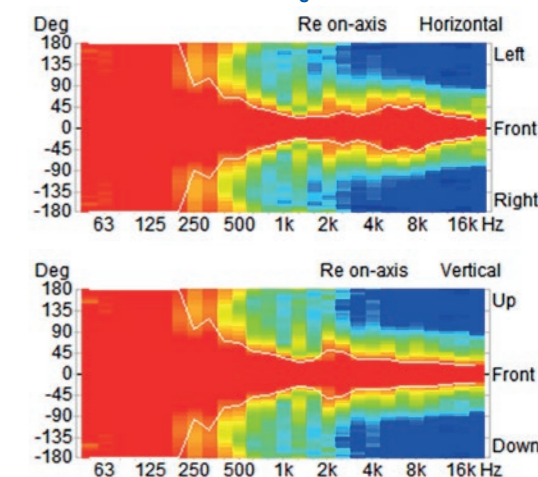

Model	PS 8250T/W VA - PS 8250T/B VA
Body & grill	ABS, Aluminium
Nominal power	250 W
Nominal Impedance	40 Ω
Power 100V Line	250 / 125 / 63 W (80 Ω)
Impedance	40 / 80 / 158 Ω
Bandwidth	75 - 20,000Hz
Sensitivity (1W/1m)	98,5 dB
SPL MAX 1m	122,5 dB
Directivity (H-V) @ 500Hz	138° - 152°
Directivity (H-V) @ 1kHz	60° - 70°
Directivity (H-V) @ 2kHz	90° - 110°
Directivity (H-V) @ 4kHz	80° - 70°
Speaker	12" + Driver
Cone	PP polypropylene
Dimensions (WxHxD)	390 x 425 x 418 mm
Weight	18,9 kg
Operating temperature	-25 to +70°C
Protection Index	IP 66
Color	White / Black

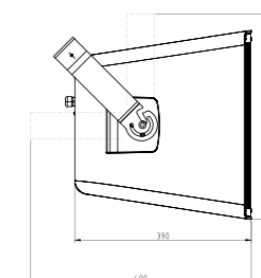
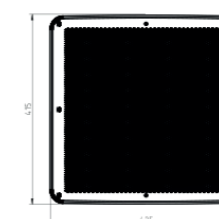

Power loudspeakers

XS 100T VA

Compact Power Speaker 25/50/100 W

- The XS 100T VA is a compact power speaker, with waveguide technology. Whether sports venues, exhibition halls or stages, the XS 100T VA offers an exceptional sound experience with excellent speech intelligibility, certified according to EN 54-24.
- Built in an impact-resistant ABS housing with an aluminium grille, the XS 100T VA is available in white. The 100W speaker is equipped with two 4" performance mid-bass woofers, a 2-way bass reflex system and a high-performance tweeter including a waveguide.
- A tweeter switch provides a 4dB boost for possible sound correction in near-wall and near-ceiling installations. The loudspeaker offers 4 different 100V power adjustments. Low-impedance operation is also possible.
- The loudspeaker is weatherproof with IP66 protection rating. A sturdy aluminium bracket ensures flexible mounting, indoors as well as outdoors.
- **This loudspeaker is also available as a professional line array (XS 100T VA ARRAY).**

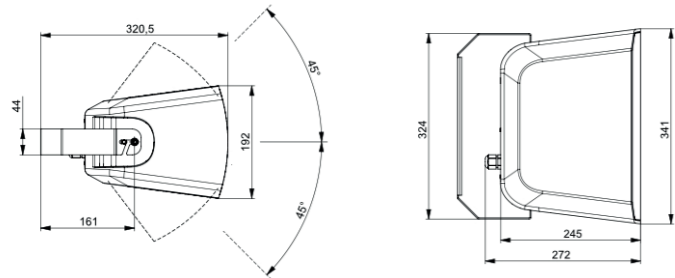

Model	XS 100T VA
Power	25/50/100 W
Impedance (100V)	100/200/400 or 1x4 Ω
Bandwidth	49-22.000 Hz
SPL, Pmax/4m	95,1 dB
Sensitivity (1W/1m)	86,3 dB
Directivity (H-V) -6dB, 500Hz	160° - 230°
Directivity (H-V) -6dB, 1KHz	65° - 140°
Directivity (H-V) -6dB, 2KHz	120° - 100°
Directivity (H-V) -6dB, 4KHz	145° - 68°
Dimensions	341 x 245 x 192 mm
IP Rating	IP66
Weight	6,5 kg
Temperature range	-25 / +70 °C
Mounting	Mounting bracket (included)
Connector	Screw terminal
Terminal diameter	2,3 mm
Maximum cable passage	4 mm ²
Colour	White

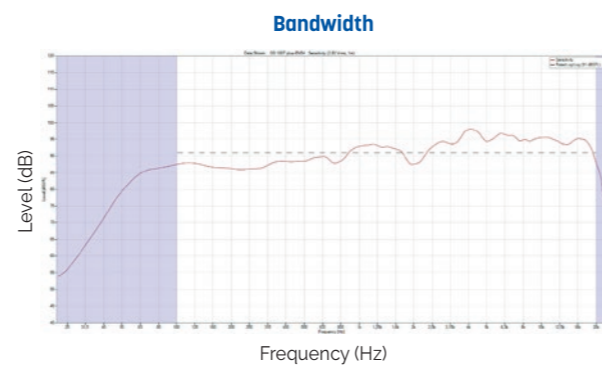

Polar Diagrams

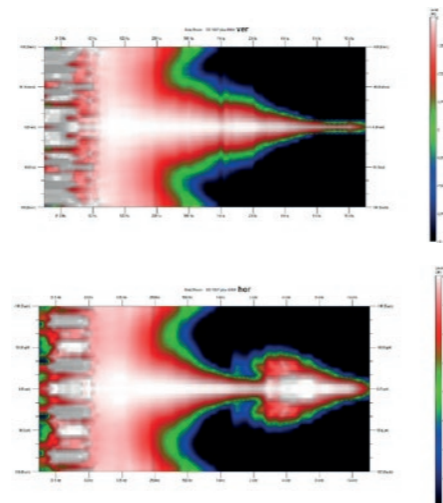

Power loudspeaker

IX8HT

2-way passive speaker 115/225W - 100V / 8Ω

- Sturdy ABS speaker for installations requiring high powers such as swimming pools, sports halls and showrooms...
- This 8" 2-way compact model, using an Eminence woofer that guarantees its quality and durability, offers clear and powerful sound in 100V line or 8Ω.



Rear panel

FICHE SPEAKON NL4

Input and link by SPEAKON male 4 pole (optional)



FIX SPE

Wall fixing

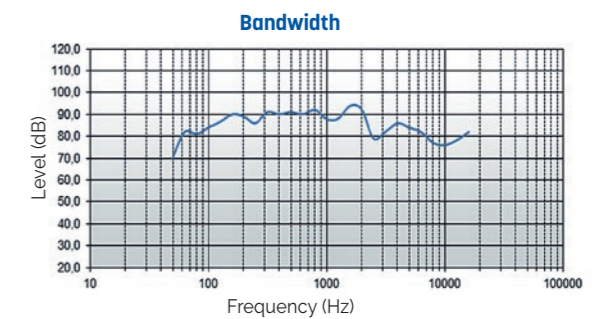

Directivity @ 1kHz

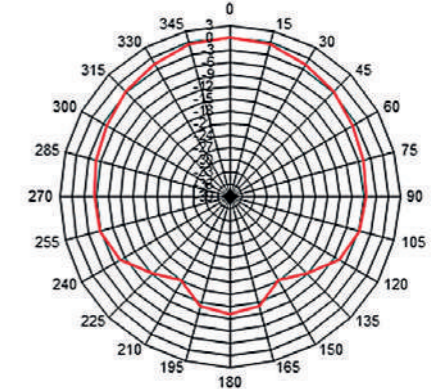

Model	IX8HT
Speaker	8" Eminence woofer + driver 1.35" titanium
Body & grill	ABS
Nominal power	225W
100V line power	115/225W
Bandwidth	60 to 20,000Hz
Sensitivity 1W / 1m	99dB
Directivity @ 1kHz	90° Horizontal / 60° Vertical
Dimensions (WxHxD)	270 x 430 x 260mm
Weight	7.9kg
Fixing	FIX SPE en option, sur demande

Power loudspeaker

SQ-10T

10" 2-Way Passive Multi-Purpose Loudspeaker 250W - 100V - 8Ω

- The SQ-10T is a 2-way point source type speaker that can be used in a variety of applications.
- With its wide and dynamic frequency response the SQ-10T accurately reproduce a wide range of frequency including a tight and powerful base.
- It can be used as a main PA, as delay or fill boxes as well as stage monitors.
- The enclosure design features multiple rigging points for easy horizontal or vertical mounting and installation convenience and a Pole Mount insert.
- Applications :
 - Sports facilities
 - House of worship, churches and cathedrals
 - Education classrooms and audio-visual
 - Fill speaker
 - Delay & Under balcony
 - Low profile foot monitor

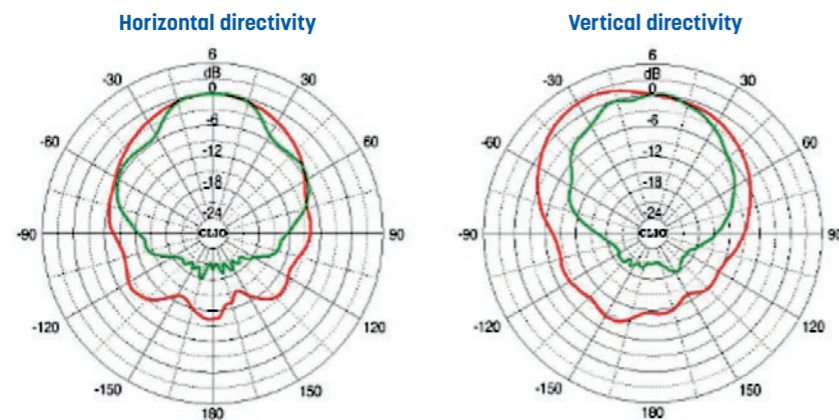
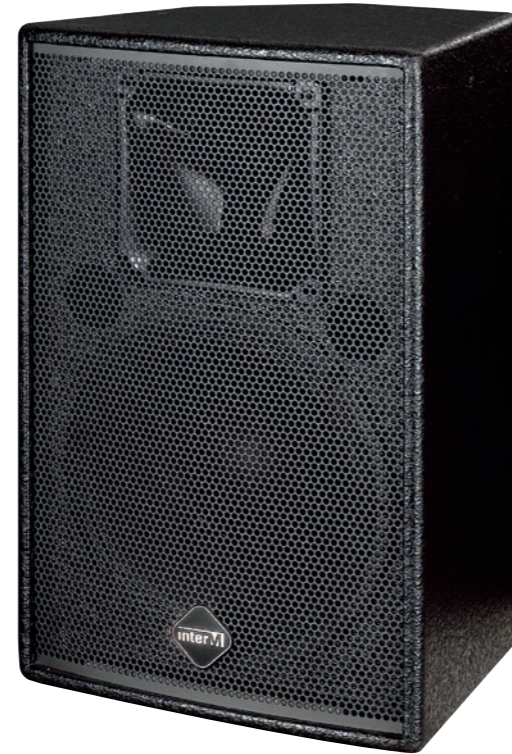

Model	SQ-10T
Driver	LF: 10" – HF: 1.35" Titanium Compression
Rated Power (AES)	250W
Rated Power (Program)	500W
Transformer Taps (70V/100V)	250W/100V – 125W/70V
Frequency Response (-10dB)	64Hz - 20kHz
Sensitivity (1W/1m)	97dB
SPL Max	127dB
Norminal Dispersion (H/V)	70°(narrow)~110°(wide) H/30°(up)~45°(down)V
Nominal Impedance	8Ω
Connectors	2xNL4 speakon
Enclosure Material	15T MDF
Dimensions (WxHxD)	330 x 480 x 330mm
Weight	14.1kg

Power loudspeaker

HE-12

2-way passive multi-purpose compact loudspeaker - 400W

- It's a passive 2-way loudspeaker with a high-performance woofer and a high-power titanium driver that adapts to a wide frequency range. Its wide bandwidth provides great broadcast clarity.

- It can be used in many environments and even used as a monitor, the directivity can be adjusted to cover the necessary stage range. In addition, thanks to its rotating waveguide, precise coverage can be achieved whether the loudspeaker is installed horizontally or vertically.
- Computer-simulated speaker tuning and passive crossover network tuning deliver linear frequency response, rich bass, and balanced tonal definition.

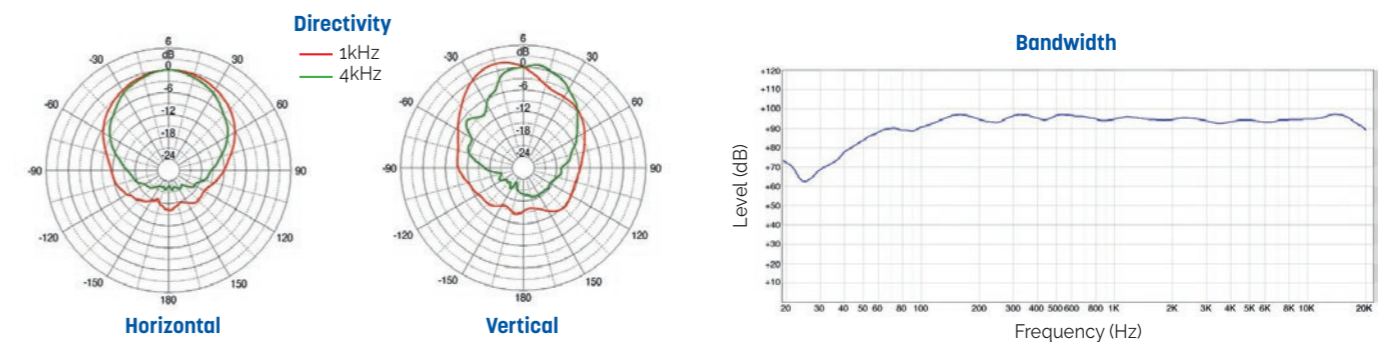
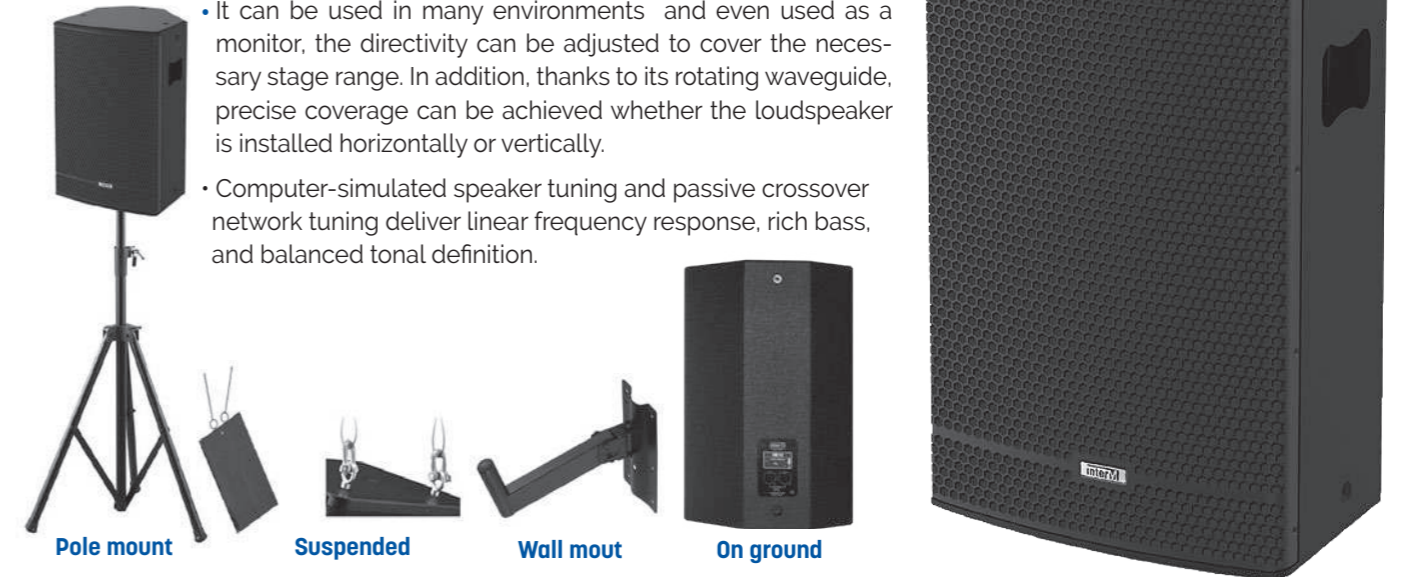

Model	HE 12
Type	12" 2Way Passive Point Source
Frequency Response (±3dB)	107Hz ~ 19kHz
Frequency Response (-10dB)	51Hz ~ 20kHz
Rated Power (AES)	400W
Rated Power (Peak)	1600W
Sensitivity (1W/1m)	94dB
Maximum SPL (Peak)	126dB
Nominal Dispersion	70° (narrow) ~ 110°(wide) H / 30° (up) ~ 45° (down) V
Nominal Impedance	8Ω
LF Driver	12" Woofer, 3" voice coil
HF Driver	1" Tweeter, 2.03" voice coil
Horn	Asymmetrical Horn (Rotatable)
Enclosure Material	High-density MDF 15T, Polyurea Coating
Grill	SECC 1.5t, Powder Coating/ BLACK
Connection	2 X SPEAKON(1+1-) [Parallel]
Fittings/Suspension	12xM10 inserts (3xtop, 3xbottom, 2xrear, 2xleft, 2xright)
Finish	Polyurea Coating
Dimensions (WxHxD)	380 x 570 x 380mm
Weight (net)	26.44kg

XS 100T VA ARRAY

Compact Line Array 4x100 W



• The XS 100T VA ARRAY combines the strengths of the XS 100T VA into a loudspeaker system that is able to cover even larger areas with excellent speech intelligibility, certified according to EN 54-24. This compact line array consists of 4 modules in a steel bracket. Each module can be adjusted in 3 vertical steps : 0, 5, 10 and 15°. This makes it adaptable to all acoustic challenges, indoors and outdoors. The loudspeaker is weatherproof with an IP66 protection rating. A safety rope is included.

• Built in an impact-resistant ABS housing with an aluminium grille, the XS 100T VA ARRAY is available in white. Each of the 100W speakers is equipped with two 4" performance mid-bass woofers, a 2-way bass reflex system and a high-performance tweeter including a waveguide.

• A tweeter switch provides a 4dB boost for possible sound correction in near-wall and near-ceiling installations. Each loudspeaker offers 4 different 100V power adjustments. Low-impedance operation is also possible.

• **These loudspeakers are also available individually (XS 100T VA).**



Model	XS 100T VA ARRAY
Power	4 x 100/50/25 W
Impedance (100V)	4 x 100/200/400 or 1x4 Ω
Bandwidth	50-22.000 Hz (Tweeter odB)
Sensitivity (1W/1m)	92 dB
Directivity (H-V) -6dB, 500Hz	182° - 62°
Directivity (H-V) -6dB, 1KHz	78° - 30°
Directivity (H-V) -6dB, 2KHz	82° - 11°
Directivity (H-V) -6dB, 4KHz	175° - 10°
Dimensions	0° : 341 x 852 x 274 mm 45° : 341 x 765 x 430 mm
IP Rating	IP66
Weight	30 kg
Mounting	Mounting bracket (included)
Connector	Screw terminal
Terminal diameter	2,3 mm
Maximum cable passage	4 mm ²
Colour	White

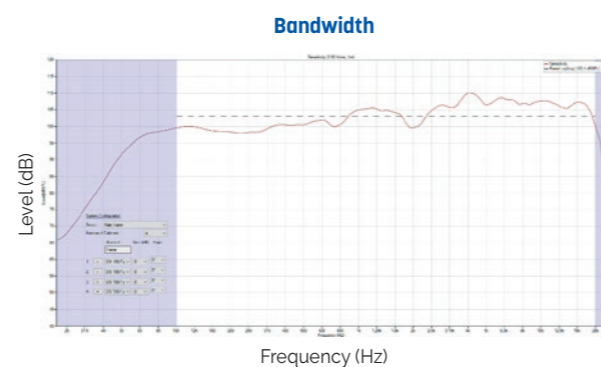
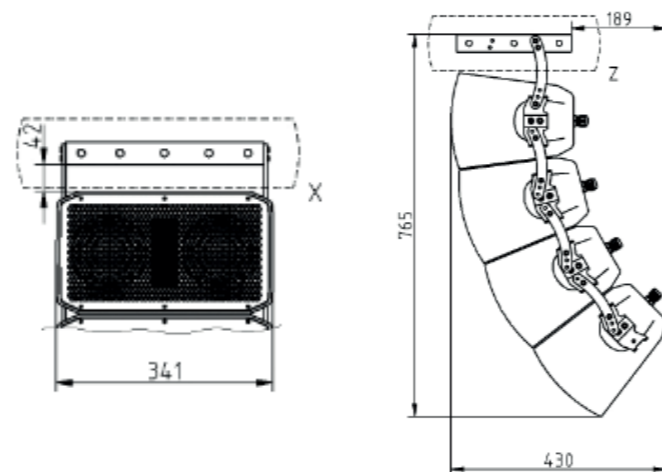

CLA-200: Compact line array 200 W - 8 Ω



• The CLA-200 is a compact speaker system configured with 4 pre-assembled modules with 4 LF cone-type and 12 HF dome tweeters for high power and quality.

• The directivity is easily adjustable. 4 angles can be chosen (15, 30, 45 and 60 degrees) as needed to optimize the sound dispersion angle.

• It can be used in low (8Ω) or high impedance (200W). The optional 100V transformer (CLA-200TR) allows the CLA-200 to be connected to a 100V amplifier when the distance between the speaker and the amplifier is very long.

• The CLA-200 features an input overload protection circuitry.

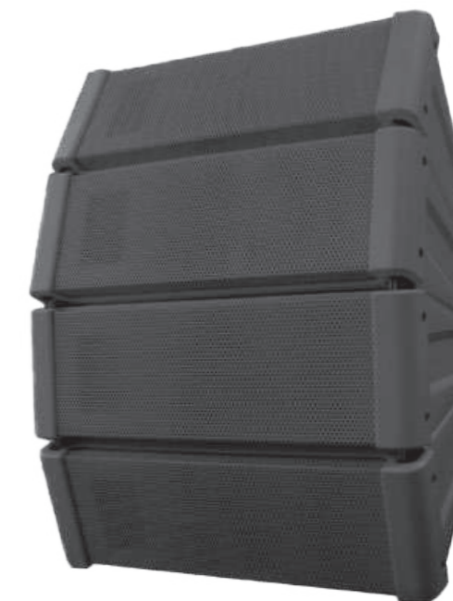

• Thanks to its removable sealing plate, the system can be used both indoors and outdoors.

• It can be mounted to the wall or hanged from the ceiling using optional accessories, vertically or horizontally.

APPLICATIONS

- Auditoriums
- Houses of worship
- Stadiums
- Sport facilities

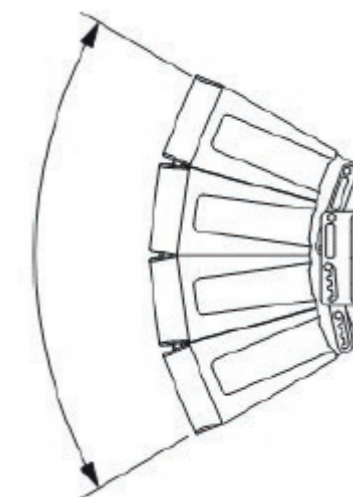

The figure shows the speaker system in 60° mode (factory-preset).

ACCESSORIES (OPTIONAL)

CLA-200CBK

- Wall or ceiling mounting bracket.



CLA-200FRAME

- Rigging frame.
- It allows the speaker to be hung from the ceiling.



CLA-200TR

- 100V transformer.



When the CLA-200TR matching transformer is installed on the CLA-200 speaker, the optional CLA-200CBK mounting bracket cannot be used.

Model	CLA-200
Enclosure	Sealed or bass-reflex (removable sealing plate)
Power Handling Capacity	Continuous pink noise : 200 W Continuous program : 600 W
Rated Impedance	8Ω
Sensitivity (1W, 1m)	96dB (60° mode) 97dB (45° mode) 98dB (30° mode) 99dB (15° mode)
Frequency Response	70 - 20,000Hz (60° mode) 75 - 20,000Hz (45° mode) 80 - 20,000Hz (30° mode) 85 - 20,000Hz (15° mode)
Crossover Frequency	4kHz
Directivity Angle	Horizontal : 100° (> 2000Hz) Vertical : 60° (> 800Hz), 45° (> 1.2kHz), 30° (> 1.6kHz), 15° (> 3.2kHz) variable
Speaker Component	Low frequency : 12cm (5") cone-type × 4 High frequency : balanced dome-type × 12
Input Terminal	2-pin connector
Water Protection	IPX4*
Finish	Polypropylene, black
Dimensions (WxHxD)	408 x 546 x 342 mm
Weight	16 kg
Operating Temperature	-15°C to +50°C
Accessories (included)	2 x suspension bracket

* Install with the every speaker module downward.

COMBO-1580

15" active portable speaker - 80W

- Combo-1580 is a compact complete sound system with a power of 80W
- It is the perfect companion for all your commercial and sport animations
- Embedding a recharging battery with multiple sources and a 5 bands equalizer
- Including a handset HF microphone (compliant with French standard), an USB/SD card reader, an AM/FM tuner, a priority microphone input and a line input all controllable via its provided remote control
- It can work on internal battery main power supply as well on 12VDC external supply.

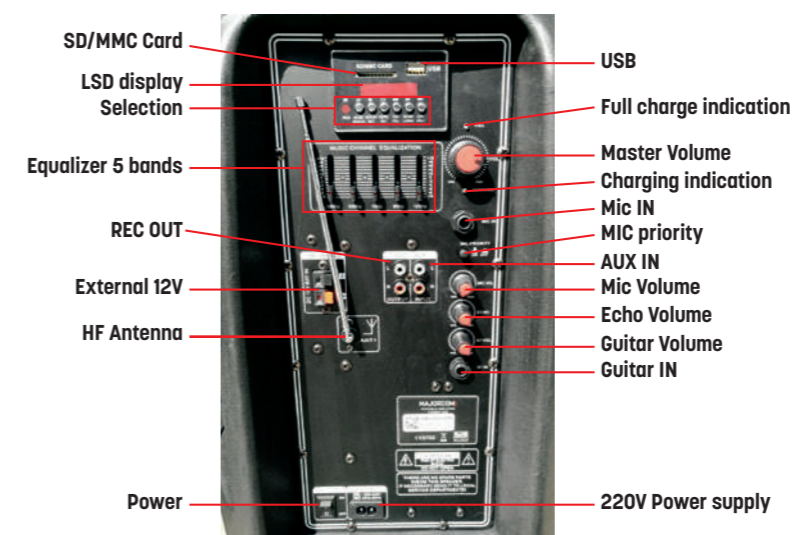

- 2-way speaker 15"
- ABS enclosure, metallic grill
- Work on battery or 220/240V 50Hz supply
- Battery 2x12V - 5.5Ah provided
- Automatic
- Colour LCD display with recording function
- MP3 USB/SD reader
- FM tuner
- Remote control
- 1 handset HF microphone

- 1 microphone Jack 6.35mm input
- 1 guitar input
- 1 Stereo line input
- 1 AUX input
- Adjustable level for each input, Master volume, 5 bands equalizer
- 1 12VDC supply input
- Priority microphone input selectable
- Telescopic handle and castors for easy transport

Model	COMBO-1580
Power	80W
THD	< 1%
Bandwidth (Hz)	55Hz - 20kHz
Inputs	LINE - MIC - GUITAR
Output	Line (for recording)
Power source	5.5Ah internal battery - 12VDC external / 220V ACV external
Sources	Media reader (USB/SD/TUNER)
HF	Handset VHF microphone 1775.5MHz
Dimensions (WxHxD)	480 x 740 x 440mm
Weight	20kg

100V Transformer

TR 100V 100V Transformer - 8Ω

- Enables the connection of a low impedance loudspeaker on a 100V line.
- So, loudspeakers of impedance 4 or 8Ω and maximum 120W power may be deported over long distances using a 100V line.
- Integrated in a watertight box, it is specially recommended for underwater loudspeakers.

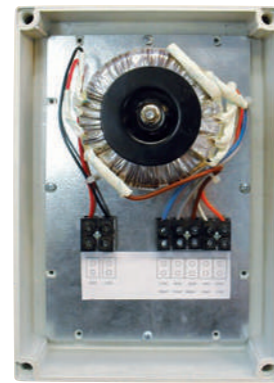

TR 100V



Closure cap

100V line Attenuators

VC 30 / VC 60 / VC 120 30/60/120W attenuators with level reset relay

- 100V line attenuators offering a complete solution for public address.
- They have a 24VDC level reset.
- Supplied with a wall fixing
- Wall mounting available as an option: **BOITIER VC S**

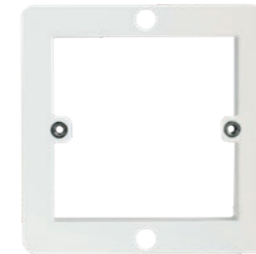

Provided wall fixing plate.



BOITIER VC S: On-wall mounting

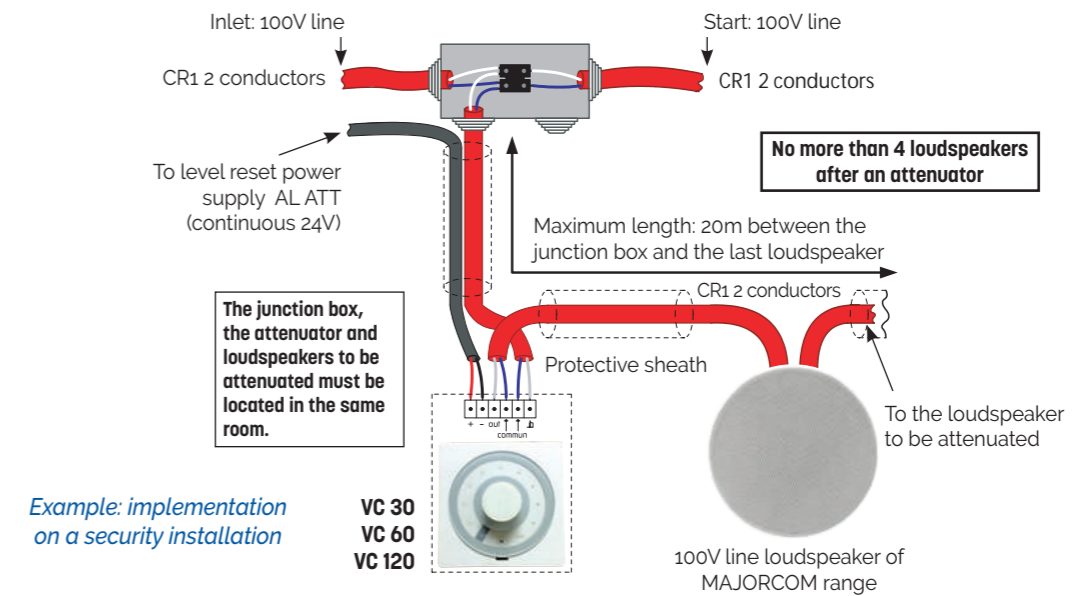

Example: implementation on a security installation

VC 30
VC 60
VC 120

Model	VC 30	VC 60	VC 120
Power	30W	60W	120W
Line voltage	100V		
Attenuation	9 x 6dB + OFF		
Bandwidth	50 to 20,000Hz		
Level reset	24VDC 20mA		
Material	Fireproof PC		
Colour	White RAL 9003		
Operating temperature	0°C ~ 40°C		
Storage temperature	-20°C ~ 60°C		
Humidity	< 95%		
Dimensions (WxHxD)	86 x 86 x 67,5mm	86 x 86 x 75,5mm	
Weight	189g	326g	

Attenuators

AL ATT

Level reset supply for VC attenuators

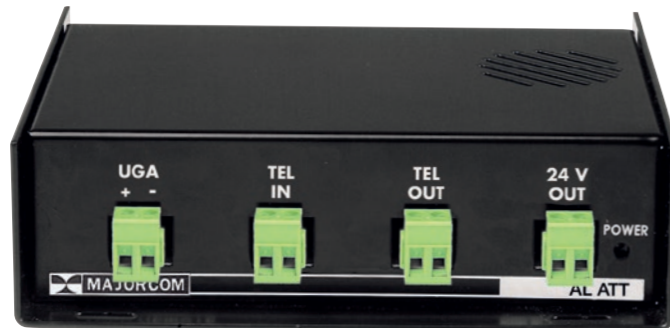

- This device is appropriate for resetting the sound level on loudspeakers fitted with (local or off-set) an attenuator with level reset relay.
- This reset can be controlled by a microphone station (MAGPL) or by a "UGA" for the evacuation message.
- The level reset is made by occurrence or breakdown of the 24V. For any use with EN 54-16 products, reset is made with breakdown. An automatic reset is then necessary due to the absence of electrical power.

Model	AL ATT
Release	24 or 48V UGA or N.O dry contact
Level reset output	24VDC
Control output	N.O dry contact
Power source	240VAC
Dimensions (WxHxD)	147 x 44 x 129mm
Weight	3kg

P ATT-19100

Panel 6 attenuators 100W 19" 10 Bearings



- 6-way PA volume controls for 482 mm (19») rack installation
- 6 audio transformers for 100 V line technique
- Connection for priority circuit, 6 priority relays (DC 24 V/20 mA)
- Attenuation in 10 steps, position 0 is OFF
- Aluminium front panel
- Available in 3 power classes
- Plug-in screw terminal
- Wall-mounted PA volume control

Model	P ATT-19100
Frequency range	50-18,000 Hz
Power rating	6 x 100 W
Priority facility	Yes
Dimensions (WxHxD)	484 x 88 x 77 mm
Weight	2kg

Speaker line measurement

IMPE

LCR meter

- It is the essential tool for all sound installations.
- It allows to measure the complex impedance of a line loudspeaker and to know the total power and the state of the line.
- It has 3 measurement frequencies, a protection fuse, two key tips and operates on a 9V battery.



PUBLIC ADDRESS ELECTRONIC



Audio source

CD 5000-B

CD/USB/SD Card/Smartphone + Tuner RDS with Bluetooth 

- Double player with an infrared remote control supplied with batteries.
- It has 2 independent sources: a tuner RDS and a CD player/SD Card/USB/Smartphone Bluetooth.
- It has two distinct modulation outputs CD/USB/SD Card/Smartphone Bluetooth and TUNER.
- Playback format: MP3, WMA, WAV.
- USB or SD Card capacity: 128MB to 16GB.
- Bluetooth is a wireless communication technology for short-range reliable and low-energy. It enables the distribution of music wirelessly from a smartphone, tablet, PC.

Model	CD 5000-B
Discs and formats	CD / CD-R / CD-RW · WAV - WMA - MP3
Tuner RDS	FM 87,5MHz/108MHz - AM 522kHz/1611kHz Preselection 30 stations Automatic station search
Inputs	Smartphone/AUX
Outputs	Two odB independent outputs RCA
Bandwidth	20 to 20,000Hz
T.H.D	< 1%
Signal / Noise	> 85dB
Memories	No internal memory
Consumption power	45W
Power source	230V - 50/60Hz
Dimensions (WxHxD)	483 x 44 x 280mm
Weight	2,3kg



Rear panel



AFM: outdoor movable radio antenna

- Lets you pick up FM radio stations when there is no reception inside the sound area.

Audio source

NTU-200

Network Audio Player

Internet Radio
DAB/DAB+
FM RDS
USB Reader

- The NTU-200 is a streaming Internet radio tuner that brings you all the audio content from the Internet from your broadband connection to your sound system. Through it users have access to more than 20,000 radio stations, podcasting broadcasters from more than 150 countries.
- Music player for easy navigation and playback through a USB library or music file network that includes support for AAC/AAC+, MP3, WMA, WAV formats.
- "Play To" feature allows media to be broadcast from a PC running Windows 7/8/10 to the unit running in Digital Media Renderer (DMR) mode.
- Digital radio exists, it is called DAB / DAB+ for Digital Audio Broadcasting and offers the advantages of digital in terms of sound quality, resistance to disturbances and some small "plus" like the display of titles and sometimes pockets, is the DAB+ which was finally chosen for the broadcasting of the Digital Terrestrial Radio (RNT) in France.
- FM Radio with RDS (Radio Data System).
- Aux in for external music sources such as MP3 players, smartphones...
- Large 2.7-inch screen for easy control and clear information display, with up to six lines of text plus status icons.
- Infrared remote control.
- Clock with automatic update function and dual independent alarm.
- Alarm clock, timer: Sleep / Snooze.
- Multiple network profiles for easy configuration.
- Menu in 13 languages.
- Android smartphone app and IOS: Remote APP / Multi Room, ideal for changing your radio stations remotely with their icons for more visual comfort, increase or decrease the volume of your remote station, start playback of your USB remote to the display of audio tracks and much more.

Model	NTU-200
Ethernet connection / Wireless	Network (TCP/IP), RJ-45 connector / Wifi
Audio output	RCA odBu +/- 3dB
Bandwidth	20 to 20,000 (odBu +/- 3dB)
THD	< 0,5%
Signal to noise ratio	RCA > 70dB
Operating temperature	0°C ~ +40°C
Power consumption	5,6W
Power source	AC 220V, 60Hz / DC13,2V / DC 24V
Dimensions (WxHxD)	482 x 44 x 185mm
Weight	3kg



Rear panel

Audio source

CD-6208

multi-sources 6 CDs & USB player with internal SD memory



- Professional multi-source USB/CD player with internal SD memory.
- Plays WAV, MP3, and WMA audio files.
- High-quality storage of up to 6 CDs. Controls are easily accessible on front panel or through the RS-232 port.
- Features output in stereo (XLR and RCA), mono (XLR), coaxial and optical.
- Device is operable using AMX and CRESTRON systems via an RS-232 port.

Model	CD-6208
Discs and formats	CD / CD-R / CD-RW · Audio CD - MP3 - WMA
Outputs	2 x XLR L/R - 1 XLR mono RCA - 2 SPDIF (optical, analog)
Bandwidth	20 to 20,000Hz ±0.5dB
T.H.D	< 0.003%
Signal / Noise	> 100dB
Memories	1 to 5 = 1GB ; 6 = 3GB (total 8GB)
Consumption power	27W
Power source	230VAC - 50Hz
Dimensions (WxHxD)	482 x 88 x 280mm · 2U
Weight	5.3kg



Rear panel

Audio source

TU-6200

FM/AM Tuner, 40 stations memories, automatic scan, RS-232 protocol, XLR/RCA connector



- Memory of 40 FM/AM frequencies: 40 broadcasting frequencies can be memorized.
- Auto Scan: Broadcast station can be selected automatically with automatic seek function.
- AMX, Crestron Interface: It supports the control port to integrate with the remote control device such as AMX and CRESTRON control systems for the user assignments.

Model	TU-6200
Frequency range	FM: 87.5 to 108.0MHz · AM: 522 to 1629kHz
Max output level	FM: 0dB · AM: -10dB
Sensitivity	FM: 2µV · AM: 18µV
THD	FM: 0.2% · AM: 1%
S/N ratio	FM: 60dB · AM: 50dB
Operating temperature	-10°C ~ +40°C
Power consumption	7W
Power source	100-120V AC, 220-240V AC, 50/60Hz
Dimensions (WxHxD)	482 x 88 x 280mm - 2U
Poids	4.2kg



Rear panel

ARM-911A**Automatic digital messages reader**

- High fidelity scalable audio for excellent speech intelligibility (MP3,WAV & WMA)
- Timer scheduled playback (can be used for school ring-tones; Evacuation messages; Containment messages; or for automatic message or playlist playback)
- Fault input monitoring and alarm via 5V reverse DC voltage with a line matching resistor at the EOL
- Scheduled playback of any of the 10 recorded messages and other via web-browser uploadable files
- Balanced audio output (variable output with -50dB/600Ω mic level, -10dB line and +4dB selector)
- Optically coupled 10 Contact Closure and RS232 for control and status
- Industrial grade all metal construction, shock and vibration resistant
- Redundant Flash memory, no battery backup required
- 10 message front panel start selections and status
- Source level, HPF and EQ adjust via web-browser
- SD Memory Playback (2GB)
- Non-Volatile SD Card memory (2GB)
- Multi-message(4) sequencing capability
- Crystal clear 24 bit audio quality
- Over 20 Minutes of audio storage capacity
- Up to 20kHz bandwidth
- Fault output monitoring
- Message playback output monitoring
- Web-browser Configuration
- Source Priority setup via web-browser
- Output Level Adjust via web-browser
- Up to 4 Remote paging mics
- Telephone paging trunk input
- Internal program scheduler
- 24VDC Back up
- Rack mount (1U)

Modele		ARM-911A			
Contact Outputs		5 Dry Contact Outputs			
Power Source		120VAC - 240VAC, 50/60Hz / 24VDC			
Power Consumption		16W			
Operating Temperature		0°C ~ +40°C			
Dimensions		482 x 44 x 280mm · 1U			
Weight		3.5kg			
		Input Sensitivity	Signal to Noise Ratio (S/N, 20kHz LPF, A-WTD)	THD (20kHz LPF)	Bandwidth (+1/-3dB)
AUX 1/2 (CH IN @1kHz)	-50dBu	-50dBu/10kΩ ±3dB	Normal: 67dB, Limit: 60dB	Normal: 0.06%, Limit: 0.15%	20 to 20,000Hz
	-10dBu	-10dBu/10kΩ ±3dB	Normal: 85dB, Limit: 78dB	Normal: 0.007%, Limit: 0.02%	
	+4dBu	+4dBu/10kΩ ±3dB	Normal: 88dB, Limit: 80dB	Normal: 0.005%, Limit: 0.015%	
	+10dBu		Normal: 102dB, Limit: 95dB		
SD CARD (Play MP3, 0dBFS 1kHz File)		-10dBu ±3dB	Normal: 94dB, Limit: 87dB	Normal: 0.01%, Limit: 0.04%	20 to 18,000Hz
RM IN (@1kHz), (RM-911D connected)		0dBu/10kΩ ±3dB	Normal: 65dB, Limit: 60dB	Normal: 0.3%, Limit: 0.7%	150 to 18,000Hz
TEL IN (TEL IN @1kHz)		-10dBu/10kΩ	Normal: 85dB, Limit: 78dB	Normal: 0.007%, Limit: 0.02%	100 to 18,000Hz
NETWORK IN (Play MP3, 0dBFS 1kHz File @1kHz)		-10dBu/10kΩ	Normal: 85dB, Limit: 78dB	Normal: 0.01%, Limit: 0.04%	20 to 18,000Hz



Rear panel

EVP-1010-I: 10 MP3 messages digital player - Impulse mode**EVP-1010-P: 10 MP3 messages digital player - Permanent mode**

- EVP-1010 messages players are suitable for the venues requiring instant audio playback such as schools, industrial sites, public and private buildings, campsites, shopping centres.
- Audio files are stored in an SD card for more convenient file management.
- User can play audio files (Total 10 audio files in MP3 format) instantly using Instant Play button on the front panel or Contact Input on the rear panel.
- Operating mode
EVP-1010-I: Impulse mode
EVP-1010-P: permanent mode
- Easy management of audio files using an SD card
- 10 instant playback buttons and status lights for intuitive operation
- 10 control inputs and outputs (dry contact)

Model	EVP-1010-I	EVP-1010-P
Operating mode	Impulse	Permanent
Audio Output Level	0dBV	
Bandwidth (±3dB)	20 to 20,000Hz	
S/N (20kHz LPF)	> 60dB	
THD (20kHz LPF)	< 0.1%	
Power source	220VAC, 60Hz, 24VDC	
Operating temperature	-10°C~+40°C	
Power consumption	5W	
Dimensions (WxHxD)	482 x 44 x 280mm - 1U	
Weight	2,96kg	

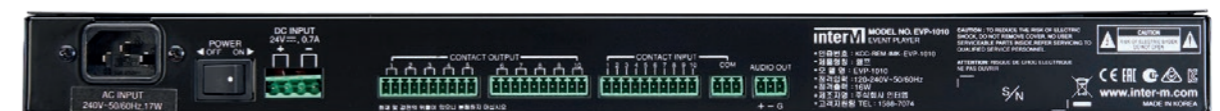

Rear panel

Messages reader

GD-16-MSG

Message reader



- The GD-16-MSG is a multi-function message reader capable of storing up to 100 different messages.
- It is intended to create events (PPMS messages, actions, etc.) triggered by different devices connected via dry contacts.
- Configuration in just a few clicks via the web interface*.
- Features 16 inputs and 16 outputs.
- Front panel LEDs monitor system status.
- A powerful annual scheduler allows you to schedule broadcasts and set up for each event :
 - Event priority vs. other events
 - Description of the event
 - Playback of a message or message sequence
 - Volume management per message

- Activation type (permanent / impulse)
- Trigger play/stop message or sequence
- Activation of one or more outputs

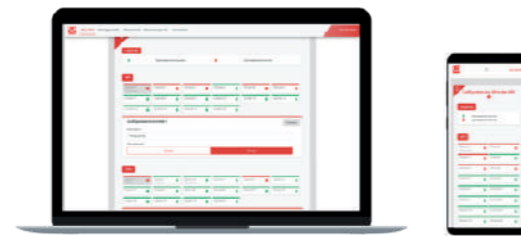

Configuration via web interface

Model	GD-16-MSG
Inputs	16 dry contact inputs
Outputs	6 dry contact outputs + 8 open collector outputs + 2 x 24V power outputs (2 x 150W) + Asymmetric 0 dB audio output
Connections	Euroblock terminal blocks
Storage	Up to 100 messages WAV / MP3 / OPUS
Network interface	Port Ethernet – RJ45 input (for configuration via web interface)
Audio formats	MP3 / WAV / OPUS
Network	Ethernet 10/100M
Power supply	24V DC
Dimensions (L x W x H)	1U / for 19" rack : 483 x 400 x 44mm
Weight	3,1 kg
Material	Metal
Color	Black
Mounting hole spacing	465 mm

* Access to the web interface via a "Wifi" device requires the GD-16-MSG to be connected to a network with a Wifi access point.

Mic Stations

MAGPL: general call with chime remote

MAGPL-D: general call with chime remote



MAGPL



MAGPL-D

- General calling Mic station fitted with a momentary press-release key and a quality microphone.
- Its plastic base gives stability and strength.
- Comes with a 1.80 m cable + DIN plug + XLR balanced adapter and remote control.

- **MAGPL**: chime remote by dry contact or cell for PAM chime (signal in short circuit on stand by)
- **MAGPL-D**: chime remote by dry contact (signal in open circuit on stand by)

Model	MAGPL / MAGPL-D
Cap	Unidirectional balanced
Remote control for chime	yes
Bandwidth	80 to 12,000Hz
Impedance	600Ω
Sensitivity	-70dB @ 1,000Hz
Hose length	270mm
Cable length	1.80m
Dimensions (WxHxD)	110 x 60 x 160mm
Weight	0,7kg

RM-01**General call + chime**

- General calling Mic station fitted with a quality dynamic microphone.
- With its small-sized microphone cap and strong base, it combines stability and design.
- Fitted with a talk key and a chime key producing a dry contact, it can fit into any kind of installation.

Model	RM-01
Cap	Dynamic unidirectional balanced
Remote control for chime	N.O (Normally Opened)
Bandwidth	100 to 18,000Hz
Impedance	600Ω
Sensitivity	-75dB @ 1,000Hz
Hose length	400mm
Base dimensions (WxHxD)	90 x 45 x 133mm
Weight	1,4kg

RM-05A**5-zone selective call for PA-212/224 ; PM-236/248/260 ; PAM-312/336/348**

- Station fitted with a high-quality electret microphone equipped with a level adjustment and a LEC volume unit metre.
- Comes with a 2m cable (7 pairs + display) SubD15 connector.
- Only works with PA-212/224 ; PM-236/248/260 ; PAM-312/336/348

Model	RM-05A
Cap	Electret unidirectional
Bandwidth	120 to 18,000Hz
Impedance	600Ω
Sensitivity	-45dB @ 1,000Hz
Hose length	400mm
Cable length	2m
Dimensions (WxHxD)	195 x 60 x 205mm
Weight	1.2kg

RM-6800**Compact Mic station for 6800/6100 Systems and PX-6216**

Rear panel

- Multi-system selective call mic station
- Up to 160 zones or zone groups, plus general calls and chime generation
- Up to 1 km away from the system with a single CAT5/6 cable, thanks to RS-422 / CAN BUS communication
- Zone group configuration for the 6800/6100 system is carried out directly with the MS-6800 system management software.
- 0 - 9 Keys, All, Talk, Chime buttons
- 2.43" OLED display
- Output level indicator
- Monitoring speaker
- Volume control : MIC / auxiliary input / monitoring speaker / chime
- Balanced 0dB audio output and 16 dry-contact remote controls for RM-g16/RM-616 mode
- DC 24V power input

Model	RM-6800
MIC input sensitivity	-50dBV
MIC output level	0dBV
S/N MIC (< 22kHz LPF)	> 70dB
Mic THD (<22kHz LPF)	< 0.1
MIC frequency response 100Hz±18kHz	0dBV ± 3dBV
AUX input sensitivity	-10dBV
AUX output level	0dBV
AUX S/N(<22kHz LPF)	> 80dB
THD AUX (<22kHz LPF)	< 0.1
AUX Frequency Response 100Hz±18kHz	0dBV ± 3dBV
Communication in RM-6024 MODE	RS-422
Communication distance in RM-6024 MODE	MAX: 1km
Communication in NRM-8000A MODE	BUS CAN
Communication distance in NRM-8000A MODE	MAX: 300m
Communication in RM-6016 MODE	Contact
Number of remote control contacts in MODE RM-6016	14 CH
Operating temperature	-10°C ~ +40°C
Power source	24VDC_x000D_ (When used with NRM-8000A MODE, 40VDC)
Power consumption	Max 10W
Dimensions (WxHxD)	200 x 73 x 206mm
Weight	1.29kg

RM-8000**8-zones selective call Mic Station for PX-8000**

- MIC Station for use with PX-8000
- Convenient installation and construction without need of ID setting
- Selection of various chime broadcasting for MIC (PRE/ POST)

- Priorities management (RM1>RM2>RM3>RM4)
- Internal monitor speaker
- RS-422 Communication for long distance

Model	RM-8000
Speech visualization	Yes
Chime remote control	Built-in chime
Number of zones	8
Bandwidth	60 - 15,000Hz
Signal / Noise	> 65dB
THD	< 0.05%
Connection	RJ-45
Power source	24VDC, 300mA (supplied from PX-8000)
Dimensions (WxHxD)	200 x 70 x 206mm
Weight	1.5kg

RM-911D**Table Mic station to trigger the ARM-911A**

- The RM-911D is a remote microphone station featuring a ten-key keypad for message playback selection. Key selection allows activation of pre-recorded message.
- The unit features a unidirectional dynamic microphone with a 14" gooseneck extension.
- An audio signal level meter is provided for displaying the signal levels at the input or output. The unit displays the ready / busy state status via a LED display.
- It can be remote powered from the ARM-911A for a distance up to 300 meters. It requires to be locally powered by an optional 24VDC when installed distance above 300m.
- Talk button can be push to talk or latch on / latch off depending on dip switch setting. A pre-announce and post announce chime is also available with a built-in 1W monitor speaker.
- Easy cat5e wiring (power, audio, communications)
- Broadcast Microphone primary supply
- Microphone Level LED output
- Selectable pre announce chime
- Status display
- 10 message start selections and status
- External Power available (24VDC Adapter)

Model	RM-911D
MIC INPUT (1kHz)	Balanced
Input Sensitivity	-50dBu ±3dB
Signal to Noise Ratio (S/N, 20kHz LPF, A-WTD)	Normal: 65dB / Limit: 60dB
THD (20kHz LPF)	Normal: 0.3%, Limit: 0.7%
Frequency Response (+1/-3dB)	150 to 18,000Hz
Monitor Amp	0.5W 16Ω
Maximum Operable Distance CAT5E (50°C)	Cable resistance ≤ 30Ω: 300m / Cable resistance ≤ 80Ω: 100m
Operating Temperature	-10°C ~ 40°C
Power Source	24VDC (From ARM-911A)
Power Consumption (From ARM-911A DC 24V)	4.8W
Dimensions (WxHxD)	200 x 67 x 206mm
Weight	1.37kg

RM-911W**Wall Mic station to trigger the ARM-911A**

- The RM-911W is a surface wall-mounted remote microphone station featuring a ten-key keypad for message playback selection. Key selection allows activation of pre-recorded message.
- The unit features a unidirectional dynamic tear-drop, push-to-talk hand held microphone with a retractable coil type cable extension.
- An audio signal level meter is provided for displaying the signal levels at the input or output. The unit displays the ready / busy state status via a LED display.
- It can be remote powered from the ARM-911A for a distance up to 300m. It requires to be locally powered by an optional 24VDC when installed distance above 300m.
- Easy cat5e wiring (power, audio, communications)
- Broadcast Microphone primary supply
- Microphone Level LED output
- In Use Status display
- 10 message start selections and status
- Up to 4 Remote paging mics can be connected to one ARM-911A
- External Power available (24VDC Adapter)

Model	RM-911W
MIC INPUT (1kHz)	Unbalanced
Input Sensitivity	-50dBu ±3dB
Signal to Noise Ratio (S/N, 20kHz LPF, A-WTD)	Normal: 63dB / Limit: 58dB
THD (20kHz LPF)	Normal: 0.3%, Limit: 0.7%
Frequency Response (+1/-3dB)	150 to 18,000Hz
Monitor Amp	0.5W 16Ω
Maximum Operable Distance CAT5E (50°C)	Cable resistance ≤ 30Ω: 300m / Cable resistance ≤ 80Ω: 100m
Operating Temperature	-10°C ~ 40°C
Power Source	24VDC (From ARM-911A)
Power Consumption (From ARM-911A DC 24V)	2W
Dimensions (WxHxD)	261 x 188 x 46mm
Weight	1.7kg

RM-N3000**IP Remote Mic Station for NCS System**

- RM-N3000 is a network only remote MIC station for paging broadcasting to each zone which can network broadcasting by select AOE / VoIP / AVB protocol.
 - In addition, users can easily set options, select zone and broadcast with high resolution OLED, 10-KEY button on the front panel.
 - MIC/external input (AUX) selectable broadcast
 - Automatic chime broadcasting
 - Configurable 5 Preset buttons
 - Output LEVEL METER LED
 - Audio output via built-in speaker
 - DC 24V (adapter available)
 - Supporting VoIP / AVB / AOE streaming
 - Supporting 100 / 1000Mbps
 - Supporting DHCP, STATIC IP
 - Supporting network bonding (AOE)
- RM-N3000 can be connected to the AOE network through the rear network terminal without any converters.
- Even if the first network fails, stable broadcasting is possible to the second network due to network redundancy.

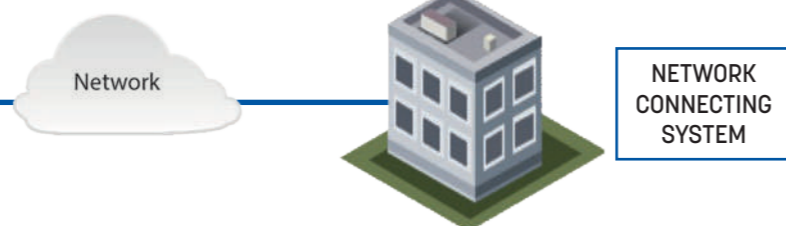

- Macro broadcasting max 1024 Zone
- STATIC/DHCP/ZEROCONFIG
- 100/1000 Network
- Support network **bonding** (AOE TCP MODE)

Teaming or **bonding** of network interfaces a server is used to combine 2 network interfaces in one virtual network interface. The network interface thus obtained can be configured as a normal network card.

One of the advantages is that in case of failure of a network card, the virtual interface continues to function as if nothing had happened. Another important advantage is that the ability 2 cards forming the virtual network interface can be combined to split the speed of your network connection.

Model	RM-N3000
Input sensitivity	MIC: -50dBV / AUX: -10dBV
Output level	0dB
S/N (<22kHz LPF)	MIC > 70dB / AUX > 80dB
THD (<22kHz LPF)	< 0.1%
Bandwidth	100 to 18,000Hz (+/-3dB)
Communication	Ethernet Network (100Mo / 1Go)
Power Source	24VDC
Consumption	Max. 10W
Dimensions (without Mic)	200(X) x 73(H) x 206(D)mm
Operating T°	-10°C ~ +40°C
Weight	1.29kg

ALIM 24VDC 1.25A
220V/24VDC - 1.25A - 30W
power supply

**DANTE DMIC 3****Dante™ Microphone console**

- DANTE DMIC 3 is a Dante-enabled desktop electret condenser goose-neck microphone. Desktop base allows microphones to be used in multi-purpose or conferencing rooms, retail stores, or large installations with big distances between the sound sources where digital audio via ethernet is the perfect solution.
- The desktop base includes a 3-pin XLR type input connector for the microphone and a Dante ethernet output connector enabling direct connection to the digital audio network. The user button with integrated red indicator permits advanced local control.

KEY FEATURES

- Dante enabled electret condenser microphone
- Wide dynamic range and frequency response
- Accurate sound reproduction
- Cardioid pattern
- Powered by PoE
- Integrated user switch control on/off
- Red LED indicator when active
- Local rotatory microphone gain control

**APPLICATIONS**

- Retail Stores
- Bars, clubs and restaurants
- Fitness Centers, hotels, schools

Model	DANTE DMIC 3
Microphone Type	Electret Condenser
Frequency Response	40Hz -16kHz (+0 -0.5dB)
Input Impedance	2.2kΩ
Max Input	0dBu
Polar Pattern	Cardioid
Sensitivity	-44dB
Power Requirements	PoE IEEE802.3af
Power Consumption	15W
Dimensions (HxWxD)	370 x 103 x 157mm
Weight	1.3kg



MD-510V
Unidirectional dynamic handheld microphone



- Unidirectional dynamic microphone with excellent frequency characteristics for voice and instrumental sound reproduction.

- Suitable for professional vocal by reinforcing mid and bass characteristics.
- Strong durability.

Model	MD-510V
Frequency Response	55Hz ~ 16kHz
Sensitivity	-75dB ±3dB
Impedance	600Ω ±30%
Dimensions	Ø 51 x 174 mm
Weight (without cable)	250g ±10g
Poids	260 g



MS 92

- Microphone stand with boom arm. Adjustable height, angle and extension. Equipped with a folding tripod ensuring good stability.
- Height adjustment: 960 to 1500mm
- Weight: 3kg



MS 94

- Microphone stand for tabletop or console with flange and heavy chrome rod.
- Threads 3/8" and 5/8"
- Dimensions: 110 x100mm
- Weight: 0.43kg



FIX MIC

- Black plastic microphone clip.
- Ø mini.: 28mm

MIC FLEX-400 / MIC FLEX-450 / MIC FLEX-610P
Gooseneck-shaped microphones



MIC FLEX-400

- Dynamic gooseneck-shaped microphone
- Balanced model
- Cardioid
- Threaded element M10 (8mm long)
- To be mounted at front panel or on microphone stand
- Total length 385mm



MIC FLEX-450

- Gooseneck-shaped dynamic microphone
- Balanced switching
- Cardioid
- XLR 3-poles connection
- Comes with microphone's wind-screen WS-40
- Total length 450 or 700mm



MIC FLEX-610P

- Electret gooseneck-shaped microphone with red illuminated ring
- Cardioid
- Windscreen
- Threaded part: Ø 10mm x 40mm
- To be mounted at front panel or on microphone stand
- Total length 450mm

Feel free to get in touch with us for any other kind of MIC Flex (length, connexion, ...).

Model	MIC FLEX-400	MIC FLEX-450	MIC FLEX-610P
Bandwidth	50 to 12,000Hz	80 to 16,000Hz	100 to 16,000Hz
Sensitivity	-74dB ±3dB	1.4mV/Pa/1kHz	4mV/Pa/1kHz
Impedance @ 1kHz	350Ω	500Ω	1,000Ω
Connection	unplugged cable	XLR	unplugged cable
Dimensions	Ø 56 - L 168mm	Ø 30 - L 450mm	Ø 13/19 - L 450mm
Weight	324g	222g	190g

MEB 102 W
Install boundary layer microphone



- Compact and unobtrusively designed, the boundary layer microphone MEB 102 W (omnidirectional) fits any style of interior and can be easily installed into surfaces such as tables or ceiling tiles.
- Each of them features approved Sennheiser microphone capsule for the best speech intelligibility, and is protected by a rugged housing.

- Unobtrusive, timeless design
- Optimized for speech
- Made in Germany

Model	MEB 102 W
Transducer	Pre-polarized condenser microphone
Directivity	Omnidirectional
Frequency response	40Hz - 20kHz
Impedance	200Ω
Sensitivity	16mV/Pa
SPL max	125dB
Dynamic range	104dB (A)
Phantom power	24-48V
Connector	XLR 3PM
Dimensions (ØxH)	28,5 x 83mm
Weight	58g

ALIM PHANTOM



- Provides 48V phantom power.

MICRO-HF EW-D MAIN : hand transmitter and digital wireless receiver set
MICRO-HF EW-D CRAV : lavalier transmitter and digital wireless receiver set
MICRO-HF EW-D CASQ : headphone transmitter and digital wireless receiver set



- Versatile and feature-rich digital wireless system for those who sing, speak or play instruments that allows for seamless product pairing and management via the EW-D Smart Assist App.
- "Digital wireless" eliminates noise, interference and static bursts
- UHF transmission greatly enhances range, reliability and scalability
- Mobile App streamlines setup and operation and eliminates complicated menus

- Automated setup creates reliable connections with minimal time and effort
- Up to 2,240 selectable frequencies
- Transmission range: up to 100m in an ideal environment (without obstacles)
- Lithium Ion battery pack delivers up to 12 hours of operation (up to 8 hours of operation with AA batteries)
- 56MHz Bandwidth will allow for up to 90 channels
- Preserves every detail of even the most dynamic performances with 134dB transmitter dynamic range

MICRO-HF EW-D MAIN

- Enjoy state-of-the-art live sound delivered by an ultra-light portable transmitter equipped with Sennheiser's famous e 835 capsule and an integrated mute button.

MICRO-HF EW-D CRAV

- The robust bodypack transmitter with metal housing and the discreet lavalier microphone (cardioid) with excellent voice intelligibility are ideal for everyday use on stage.
- Cardioid lavalier microphone equipped with a gold-plated connector.

MICRO-HF EW-D CASQ

- The robust bodypack transmitter with metal housing and the headset microphone with excellent voice intelligibility are ideal for everyday use on stage.
- Cardioid headband microphone equipped with a gold-plated connector.

Contents of sets

MICRO-HF EW-D MAIN	MICRO-HF EW-D CRAV	MICRO-HF EW-D CASQ
<ul style="list-style-type: none"> • Rack receiver • Handheld transmitter • Microphone module • Microphone clamp • 2 rod antennas • Power supply with country adapters • Rackmount set • 4 rubber feet • Quick guide • Safety guide • Manufacturer declaration sheet 	<ul style="list-style-type: none"> • Rack receiver • Bodypack transmitter • Lavalier microphone • 2 rod antennas • Power supply with country adapters • Rackmount set • 4 rubber feet • Quick guide • Safety guide • Manufacturer declaration sheet 	<ul style="list-style-type: none"> • Rack receiver • Bodypack transmitter • Lavalier microphone • 2 rod antennas • Power supply with country adapters • Rackmount set • 4 rubber feet • Quick guide • Safety guide • Manufacturer declaration sheet

EW-D CHARGING SET : Charging set for transmitter

- The set includes an L 70 USB charger, 2 BA 70 rechargeable batteries and a power supply for use with the bodypack and the handheld transmitter from the MICRO-HF EW-D series.

- MICHF-PRO MAIN:** hand transmitter and wireless receiver True Diversity set
- MICHF-PRO CRAV:** clip-on transmitter and wireless receiver True Diversity set
- MICHF-PRO CASQ:** headphones transmitter and wireless receiver True Diversity set

**MICHF-PRO MAIN**

- This Set takes user to the front of stage. The micro capsule guarantees a great insensitivity to acoustic clashes with the already legendary head e 835.
- Easy to use, the MICHF-PRO MAIN is ready to use for any presenter.
- Capsule e 835 for high levels on stage
- Strong insensitivity to the larsen
- "Mute" button for a total control
- Remote synchronization via HF
- Adjustable frequencies by 25kHz steps
- 24MHz band width (13MHz for the E band)
- 8 frequency bands allowing up to 12 presets each
- **Rackmount set included**

MICHF-PRO CRAV

- Virtually invisible, this presenter set all-in-one is ideal for stunning presentations.
- The clip-on professional microphone ME 2-2 easily attaches to your clothing, ensuring a faithful and powerful transmission of your voice to captivate your audience.
- Easy-to-use, the MICHF-PRO CRAV is ready to use for the presenter.
- Clip-on microphone almost invisible
- Very high speech intelligibility
- "Mute" button for a total control
- Remote synchronization via HF
- Adjustable frequencies by 25kHz steps
- 24MHz band width (13MHz for the E band)
- **Rackmount set included**

MICHF-PRO CASQ

- Lightweight and comfortable, this package offers you a total freedom of movement, the guarantee of an impressive and lively performance.
- The professional cap of the head-worn microphone ME 3 delivers a crystal clear sound, even in noisy environments.
- Easy to use, this set is ready to use for the presenter.
- Hands-free
- Exceptional sound quality
- "Mute" button for a total control
- Remote synchronization via HF
- Adjustable frequencies by 25kHz steps
- 24MHz band width (13MHz for the E band)
- **Rackmount set included**

EW-D EM : rack receiver



1/2 19" rack receiver for use with Evolution Wireless Digital handheld and bodypack transmitters. Versatile and feature-rich digital wireless system for those who sing, speak or play instruments that allows for seamless product pairing and management via the EW-D Smart Assist App. Receive state-of-the-art live sound.

- Digital wireless eliminates noise, interference and static bursts
- UHF transmission greatly enhances range, reliability and scalability
- Mobile App streamlines setup and operation and eliminates complicated menus
- Automated setup creates reliable connections with minimal time and effort
- Up to 2,240 selectable frequencies
- 56 MHz Bandwidth will allow for up to 90 channels
- Preserves every detail of even the most dynamic performances with 134 dB transmitter dynamic range
- All metal housing

DELIVERY INCLUDES

- EW-D EM rack receiver
- 2 rod antennas
- power supply with country adapters
- **rackmount set**
- 4 rubber feet
- quick guide
- safety guide
- manufacturer declaration sheet



Rear panel

PM-835: USB, BT, FM, AUX IN, Micro SD Wall Multimedia Plate - 2 x 10W - 8Ω

- Standard case 86mm, sleek design with LED screen
- Integrated high efficiency amplifier 2x10W at 8Ω
- Built-in music source: USB, Micro SD, Bluetooth and FM, AUX inputs and outputs
- Can store 20 radio channels, supports automatic and manual search
- Bandwidth: 20Hz ~ 20kHz for an excellent musical effect
- With IR remote control for more convenient use



- The PM-835 is a practical and effective wall-mounted multimedia player. With a neat and refined design, this wall plate offers you many audio sources, including FM radio, a micro SD card reader, a Bluetooth receiver, and a USB drive, AUX1 auxiliary input and AUX2 auxiliary output.
- The PM-835 supports the most common audio formats such as MP3, WMA, WAV, AAC, FLAC, etc. and the FM radio can store and store up to 20 radio stations.
- This multimedia player also includes a digital amplifier Class D type which delivers a power of 2x10W RMS with an impedance of 8Ω with a frequency response of 20Hz-20kHz.
- This deck also comes with an infrared remote control for convenient and comfortable use, its LED display screen allows you to see the selected source, time, title and the total number of songs on the screen.

Model	PM-835
Output power	2 x10W
Impedance	8Ω
Harmonic Distortion Rate	≤0.03% (1kHz, 1W, 8Ω)
Signal to Noise ratio	> 81dB
Frequency response	20Hz -20kHz
Max capacity Micro SD card	32GB
Audio Format	MP3, WMA, WAV, AAC, FLAC...
Bluetooth	BT2.1+EDR
Power	AC 100-240V/50-60Hz
Dimensions (W x H x D)	86 x 86 x 38mm
IR Remote control	Range 8-12m A +/-60° directionality
AUX1 Input Sensitivity	Stereo Unbalanced 0dB
AUX2 Output Sensitivity	Stereo Unbalanced 0dB

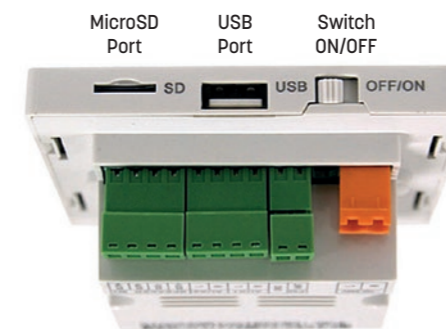
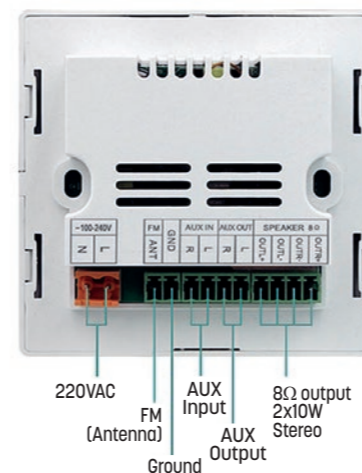

Mounting surface included



**In Wall Mounting (optional)
BOITIER PM E**

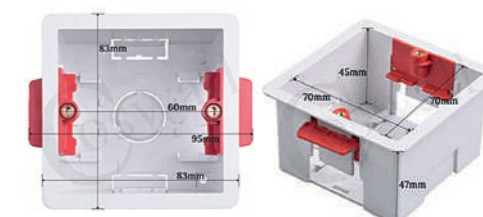

PM-839 : USB, BT, FM, AUX IN, Micro SD Wall Multimedia Plate - 2 x 25W - 8Ω

- Standard 86mm case, sleek design with 4" TFT color touch screen.
- Integrated high efficiency amplifier 2x25 W at 8 Ω.
- Android 7.1, 1GB memory expandable to 32GB by micro SD.
- Resolution 480*480 IPS.
- Integrated music sources: micro USB, Micro SD, Bluetooth and applications, AUX input, AUX output and an RS485 port.
- RJ45 ethernet connection or WIFI.
- Dry contact On/Off.
- 20Hz ~ 20kHz bandwidth for excellent musical effect.
- The PM-839 is a practical and efficient wall-mounted multimedia player. With a sleek and clean design, this board offers many audio sources (micro SD card reader, Bluetooth receiver, micro USB OTG reader), an AUX input, an AUX output and an RS485 communication port.
- The PM-839 supports the most common audio formats such as MP3, WMA, WAV, AAC, WAW, APE, OGG, etc.
- The PM-839 supports the most common video formats such as MPEG1/2/3/4, RM/RMVB, WMV, MOV, MK, VOB, AVI, 3GP, H264, etc.
- This multimedia player also integrates a class D digital amplifier which delivers a power of 2x25W RMS under an impedance of 8Ω with a frequency response of 20Hz-20 kHz.
- Its 4" TFT color touch screen display allows for user-friendly and modern operation.
- The PM-839 also comes with an infrared remote control for convenient and comfortable operation.



Model	PM-839
Power output	2 x 25W
Impedance	4/8Ω
THD	≤0.03% (1kHz, 1W, 8Ω)
Signal to noise ratio	> 98dB
Frequency response	20Hz -20kHz
Max micro SD card capacity	8 to 32GB
Audio Format	MP3, WMA, WAV, AAC, WAW, APE, OGG...
Bluetooth	BT4.0 / max range 10 meters
Power supply	AC 100-250V/50-60Hz
IR remote control	Range 8-12m at +/- 60° directionality
AUX input/output sensitivity	0dB unbalanced stereo
System	Android 7.1 without Google service
Internal memory	1GB
Network	Ethernet RJ45 / WIFI
CPU	Cortex 1.2G (Quad Core)
Display	4" touch screen
Resolution	480*480 IPS
USB	OTG USB 2.0
Video Format	MPEG-1-2-3-4, RM/RMVB, WMV, MOV, MK, VOB, AVI, 3GP, H264, etc.
Dimensions (L x H x P)	86 x 86 x 38 mm
Weight	0,7 kg

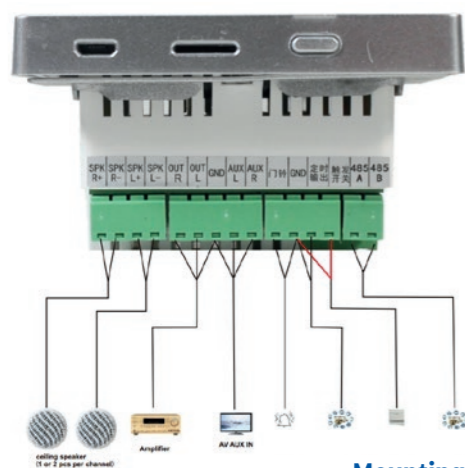

Mounting surface included



In Wall Mounting (optional)
BOITIER PM E

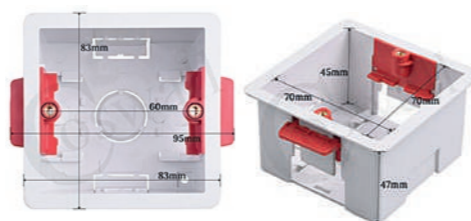

LM-306

IP (PoE) panel for triggering messages for ARM-911A

LM-306 is a compact 6-button remote control ideal as a user interface keypad in an ARM-911A message control system.



- **Clear and Customizable User Interface:** RGB-color, tactile feedback, backlit buttons with custom labeled, removable button caps, allowing simple and intuitive end-user and guest control over facility deployed devices and systems.
- **Programming:** all you have to do is modify or add the IP address of the ARM-911A assigned to you by your network administrator (this operation must be carried out during commissioning).
- **Easy and Cost-effective Installation:** compactly fits into standard US, EU and UK 1-gang in-wall box size, allows decorative integration with room deployed user interfaces such as electrical switches. Keypad installation is fast and cost-effective via a single LAN cable providing both power (PoE) and communication connections.

Model	LM-306
Enclosure	1-Gang EU Control Keypad
Ports	1 Ethernet: On an RJ-45 female connector for PoE, device configuration, control and firmware upgrade
General	Default IP Settings DHCP Enable
Power	Source: PoE or 12V DC 2A power supply
Consumption	12V DC, 780mA
Operating T°	0°C ~ 40°C
Stockage T°	-40°C ~ 70°C
Humidity	10% to 90%, RHL without condensation
Accessories	Included: 12V DC power adapter, special tool to remove button caps, standard button label set (8.8 x 8.8mm)
Dimensions (WxHxD)	80 x 80 x 47mm
Weight	100g
Regulatory	CE, UL, RoHS, WEEE

LM-911A**Wall remote message control plate for the ARM-911A**

- It's a wall remote control device to control the ARM-911A's first 4 audio sources in a remote location by synchronizing with the ARM-911A. It connects to the RM contact port of ARM-911A, and uses the RS-422 communication method. By pushing any of the 4 different buttons on the front panel, users can control the first 4 audio sources remotely.

- Connect up to 4 x LM-911A or 4 Paging MIC RM-911A on your ARM-911A
- Dimensions (W×H×D): 114×70×50mm
- Weight: 123g

Automatic digital messages player [\(see p.214\)](#)

ARM-911A

PE LM-8000
flush-mounting plate
(included)



BS-LM8000
case enabling
surface mounting
(optional)



ATT-BOX
Box booking
masonry
(optional)

**M-ZR-PPMS****PPMS control panel**

- The M-ZR-PPMS is a 4-button box for triggering pre-recorded PPMS/PPI/POI messages.
- It is compatible with ARM-911A, EVAMATRIX, EVP-1010-P, NAI-1104 and IP-1015BX products.
- It can trigger up to 4 different messages.
- Each button can be programmed according to the message reader it is associated with in order to broadcast the desired message.
- Each button operates in ON/OFF mode. The first press triggers the message, the second stops it.
- Several M-ZR-PPMS units can be cascaded to meet all your needs.

APPLICATIONS

- Elementary schools
- High schools
- Middle schools
- Boarding schools

Model	M-ZR-PPMS
Number of buttons	4
Connection	Screw-type
Power supply	Without power supply Dry contacts
Dimensions	167 x 88 x 50 mm
Color	Housing : White Lexan : Black and Grey
Material	Shockproof ABS
Weight	0,500 kg

LM-8000**Animation deck for PX-8000**

- Local animation deck with audio In
- For use with PX-8000
- Convenient installation and construction without need of ID setting
- Remote volume control and selection of BGM
- Independent local MIC and BGM broadcasting

- Jut out mounting, classic electric enclosure
- RS-422 Communication for long distance
- Dimensions (WxHxD): 70 x 114 x 52mm
- Embedding dimensions: 50 x 70mm
- Weight: 130g

PE LM-8000
 flush-mounting plate
 (included)

BS-LM8000
 case enabling
 surface mounting
 (optional)

ATT-BOX
 Box booking
 masonry
 (optional)
**BA-MIX****2-Channel Wall-Mounted Audio Mixer**

- It allows mixing an unbalanced stereo signal (2xRCA) with a MIC signal (XLR), obtaining a balanced mono output that can be sent to preamplifiers, amplifiers, digital or analog matrices, etc., thus saving inputs to the receiving device.
- The MIC input includes a 2-band equalizer (bass, treble) and can use the talk-over function to fade the RCA line signal when the microphone input exceeds the talk-over detection threshold.

**KEY FEATURES**

- Unbalanced stereo line input (2xRCA)
- Balanced MIC input with BASS and TREBLE controls and selectable phantom power
- Independent volume controls for LINE and MIC inputs
- Talk-over function available (MIC on LINE)
- External power supply required (15 V DC or 24 V DC)
- Surface mount box included
- Available in white color (RAL 9016)

APPLICATIONS

- Hotels
- Restaurants
- Shops
- Shopping centers
- Buildings
- Exhibition centers
- And much more...

Model	BA-MIX
Input Sensitivity/Impedance	LINE: -10dBV / 10kΩ • MIC: -40 or -20dBV / > 1kΩ ("internally selectable)
Output level/ Minimum load	0dBV / 600Ω (max. +17dBV)
Frequency response	LINE: 5Hz - 30kHz • MIC: 10Hz - 40kHz
THD	LINE: < 0.005% • MIC: < 0.01%
CMRR	MIC: > 55dB @ 1kHz
Signal / Noise	LINE: > 105dB • MIC: > 90dB
Tone control	BASS: 100Hz ± 10dB • TREBLE: 10kHz ± 10dB
Talk-over	-30dB/ 3 s aprox.
Phantom voltage	+15VDC
External power supply	15VDC or 24VDC (min. 30mA)
Power consumption	25mA
Dimensions (WxHxD)	86 x 86 x 30mm
Weight	125g

Optional accessories
 Power supply
 AL BA-MIX

 Box for
 surface
 installation
MODULE
SAILLIE BA

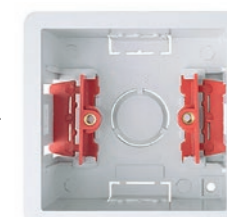
 Wall
 recessed
 box
BOITIER PM E

Interface

MOD TEL 2**Analog telephone interface with messages reader**

- It is an easy-to-use interface which combines in a single product functions of a phone line announcer and a digital messages reader.
- When it is connected to a PA system, simply plug the analog telephone line into the product and dial its number to broadcast an announcement from any phone.
- It can broadcast recorded digital messages which can also be triggered from the 6 GPI.
- DTMF messages triggering and many other settings are possible by following simple configurations.
- Audio files can be customized to match the announcement or alert messages required by each institution.
- MP3 or WAV supported digital audio format allows you to broadcast quality messages previously stored in the integrated SD card provided and with the MOD TEL 2.

Model	MOD TEL 2
Output	1V, 600Ω, balanced
Output relays	30V, 50mA
Settings	volum and chime tonality, output level, busy tonality
Power source	AC 240V - 12 to 24VDC
Dimensions (WxHxD)	126 x 40 x 115mm
Weight	0.310kg

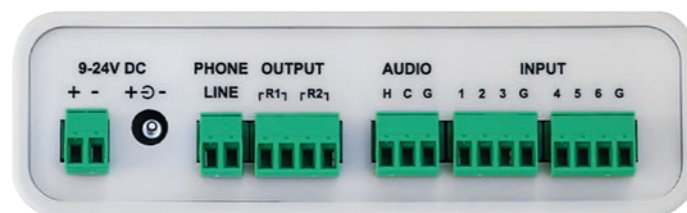

Rear panel

Interface

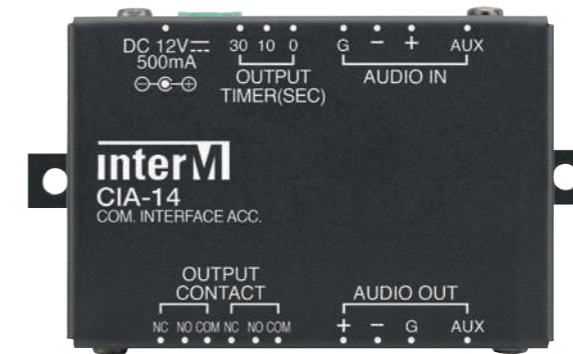
CIA-14**Voice remote control**

- This module provides a dry contact (NO or NC) when audio signal is present on its input in order to control for example an amplifier on or off.
- The dry contact release time can be set: 0, 10 or 30 seconds.
- The input is a Mic / line level adjustable and the output is a 0dB symmetrical.

Model	CIA-14
Input	Mic/Line balanced
Output	0dB balanced
Release time	0, 10 or 30s
Frequency response	20 to 20,000Hz
Power supply	12VDC 500mA
Dimension (WxHxD)	93x52x27.8mm
Weight	120g

Digital audio Matrix

PX-6216 compatible equipments and accessories

PX-6216 14x8 digital audio matrix up to 32 mic stations



- This DSP-based 14 x 8 digital audio matrix is configured, controlled and monitored by a PC via the MS-6800 custom system control software.
- The PX-6216 is designed to provide professional quality sound and intelligibility with the high performance required for mass notification.
- This matrix offers up to 8 priority levels per fade output (via its modulation detection system).
- MIC/LINE inputs with 7-band EQ, input/output volume control and mixing.
- 6 presets and control (Preset).
- CD-6208 / TU-6200 / ARM-g11A type external source control...
- 8 balanced audio outputs
- High S/N ratio
- Good dynamic range without compression
- The system offers a cost-effective solution for background broadcasting and mic calls.
- Supports full two-channel stereo sound
- 4 RJ45 ports for multi-zone call microphone expandable up to 32 via the RME-6108
- 8 mic/line inputs (2 with phantom power)
- 2 unbalanced line inputs

Model	PX-6216
Output	0dBV balanced
Inputs	EM, TIMER, RM: -10dB balanced / LINE 1-8: -10dB balanced MIC 1-8: -50dB balanced / LINE 9, 10: -10dB unbalanced
Bandwidth $\pm 3dB$	20 to 20,000Hz
THD	LINE < 0.01% / MIC < 0.1%
Signal/Noise	LINE > 85dB / MIC > 60 B
Max Signal/Noise	> 100dB (+8dBV input)
Phantom power source	1, 2 : 24VDC
Priority	RM1 > RM2 > RM3 > RM4 > BGM
Communication	LINK IN/OUT: RS-485 (Max. 1km) / RM: RS-422 (Max. 1km) / Source: RS-422 (Max. 12m)
Operating temperature	-10°C ~ 40°C
Power source	24VDC, 1A
Dimensions (WxHxD)	482 x 88 x 280mm · 2U
Weight	4.3kg



Rear panel



RM-6800
Selective call system
mic station
[\(see p.220\)](#)



DIB-6000
PC USB
interface
[\(see p.106\)](#)



RME-6108: Mic station extension [\(see p.107\)](#)
Per cluster of 8 (Max 4x RME-6108 for a max total of 32x RM-6800)

MS-6800
Software
Free
[\(see p.98\)](#)



Applications

Educational institutions

Schools, Universities and Colleges, Training facilities

- Educational institutions often need to make scheduled broadcasts and send messages instantly to specific zones over long distances, for instance across a building or campus.
- The PX-6216 matrix allows personalized and scheduled calls to be made in classrooms and thanks to its high quality audio system, it can broadcast, on demand, audio streams in specific areas (classrooms, conference rooms, amphitheatres, etc.).

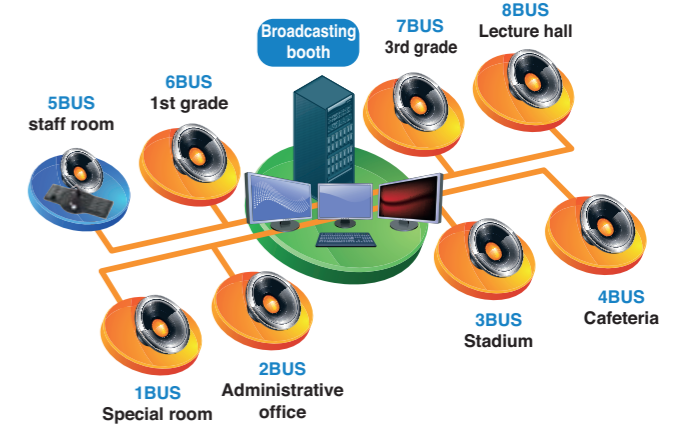

Public spaces

Office buildings, Train stations, Airports, Hospitals...

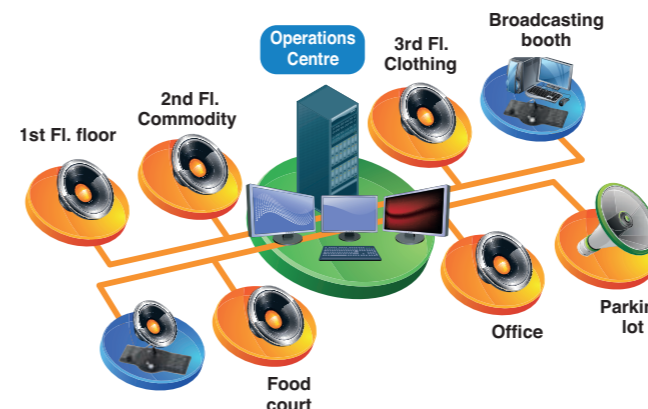

Some zones of public spaces may require soft background music, while others may need frequent announcements, whether scheduled or live. PX-6216 matrix has a flexible broadcasting and sound source feature, which lets you control the sound source for the entire network, making it the ideal system for use over networks.

Commercial establishments

Shopping centres, Multiplex theatres, Large hotels...

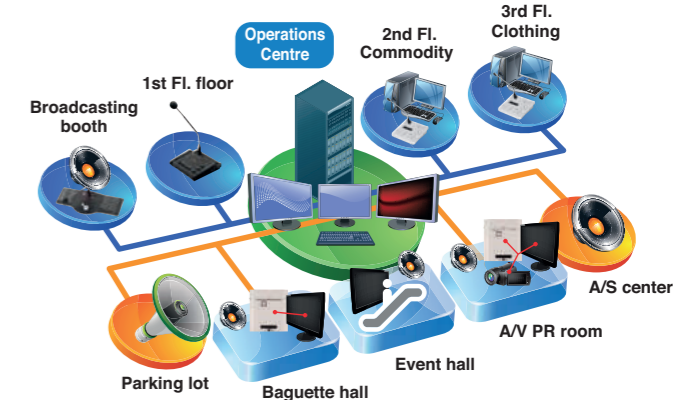

Commercial establishments require various types of background music coming from local sources and specific announcements that vary according to zone. The PX-6216 matrix allows flexible control and broadcasting from various locations, such as the command centre, the information centre, or service centres.

PX-6120
6x6 amplified Matrix with USB/SD/FM/BLUETOOTH



PX-6120

- 6 zone amplified matrix with 6 outputs of 120W.
- 4 audio inputs, 1 integrated source and 1 super priority EMC input.
- MP3/FM/Bluetooth player, 3 mic/line inputs, auxiliary input and EMC priority input.
- 6 amplifier channels that can receive the chosen audio source or input individually, volume control of the zones.
- 6 zone amplified matrix with remote volume control and remote microphone.
- 6 RJ45 connections that can accommodate remote microphones and or wall volume plate up to 200 meters by cat5/6 cable.
- 6 zones of loudspeaker outputs in 100V or 4/8 Ohms.
- 3 switchable XLR balanced mic/line inputs with 48V phantom power.
- 1 auxiliary input and a built-in USB/SD/FM and Bluetooth player can be switched per matrix to one of the 6 zones independently.
- 6-zone selective microphone desk.
- USB/SD/FM audio player and remote control.
- 24V control to trigger an alarm message (editable).

RM-6000

6-zone remote microphone

- Communication via CAT 5 cable up to 200 meters
- Self-powered directly by the matrix.
- Source selection and volume control
- Touch panel
- Up to 6 remote microphones for PX-6120 matrix.



LM-6000

Bluetooth wall control panel

- Communication by CAT 5 cable up to 200 meters.
- Self-powered directly by the matrix.
- Source selection and volume control.
- Touch panel.
- Up to 6 plates per PX-6120 matrix.
- Dimensions : 86 x 86 mm.



PX-6120 rear panel



Model	PX-6120
Zones	6
Rated output power	6x120W
Speaker output	100V & 4-8Ω
Inputs	Mic/line1-3: 2,5mV, balanced XLR input with 48V phantom power, Line 1-2: 250mV, RCA Mute: 250mV, Phoenix connector
Remote mic	Up to 6 RM-6000 per matrix PX-6120MX
Wall plate volume/source	Up to 6 LM-6000 per PX-6120MX matrix
Bandwidth	80Hz - 16,000Hz
THD	< 0,1%
S/N ratio	> 70dB
Protection	High temperature, short circuit and overload protection.
Power source	AC230V or AC110V, 50-60Hz
Power consumption	900W
Dimensions (WxHxD)	484 x 88 x 320mm
Weight	15,5kg

PA example: HOTEL

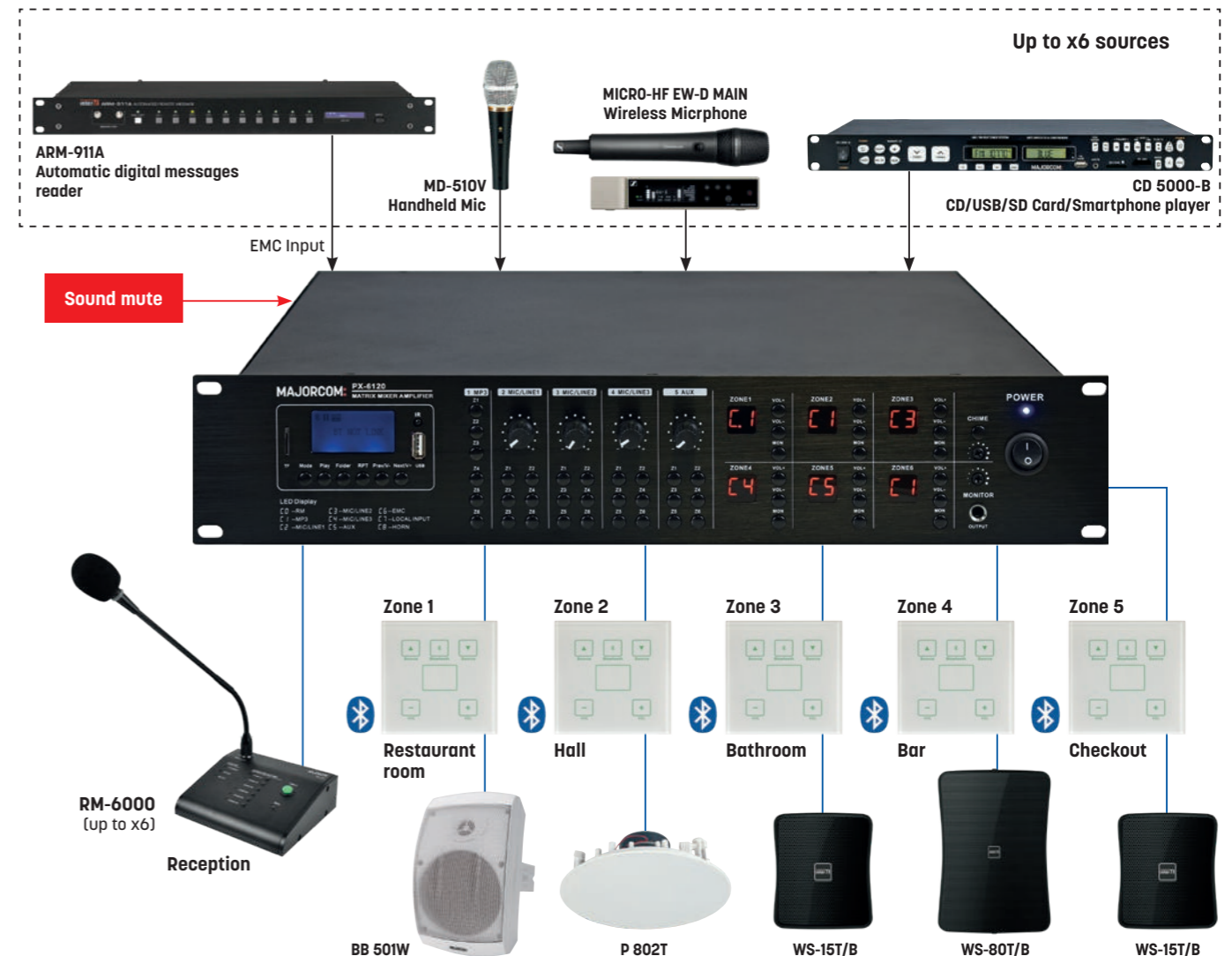

DNM-88 · DNM-88D · DNM-1616 · DNM-1616D

Programmable digital audio matrix processors

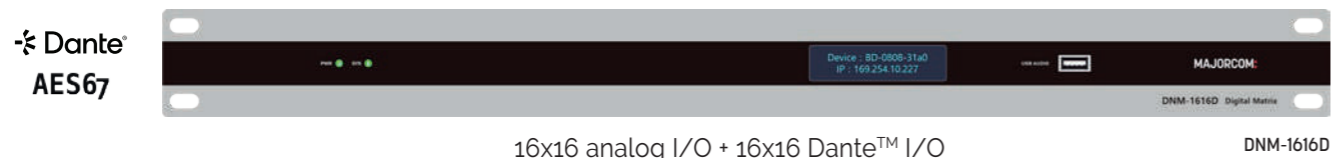

FEATURES

- DSP processing : 400 MIPS, 1,6 GFLOPS.
- Sampling rate : 48 kHz, ± 100 ppm.
- THD+N : <-94dB @4dBu.
- Input dynamic range: 110dB.
- Output dynamic range: 112dB.
- The processing modules are configurable and freely interchangeable as required.
- 8 units available for in-line operation simultaneous.
- Built-in USB sound card with one input and one output, supporting music playback, recording and soft video conferencing.
- For example: ZOOM, Teams, Tencent meeting, etc.
- Bus-based ACS, waiting time : 512 ms, convergence rate: 60 dB/S, echo cancellation amplitude: 60 dB.
- AFC (feedback suppression) for independent channels with trap-type algorithm, amplitude of sound transmission gain improvement: 10 dB.
- Noise suppression (ANS), improved ratio S/N of 18 dB.
- Priorities (Ducker).
- Noise gain compensator (ANC).
- Automatic gain sharing mixer (AMC), Automatic gate mixer (Gate Mixer).
- 12-band parametric EQ with 5 filter options.
- Parametric, Lowshelf, Highshelf, Lowpass, Highpass.
- Customizable interface for the end user, up to 30 units with the same interface management; support for camera tracking.
- With 8 GPIO channels.
- With centralized control function, support for : RS232, RS485, UDP three kinds of control mode.

Model	DNM-88	DNM-88D	DNM-1616	DNM-1616D
Processor	ADI SHARC 21489 @450 MHz SIMD	ADI SHARC 21489 @450 MHz SIMD x2	DI SHARC 21489 @450 MHz SIMD	ADI SHARC 21489 @450 MHz SIMD x2
Sampling rate/quantification bits	48K/24bit			
Number of analog input and output channels	8x8	8x8	16x16	16x16
Number of Dante input and output channels		8x8		16x16
Input gain	0/3/6/9/12/15/18/21/24/27/30 33/36/39/42/45/48 dBu			
Phantom power supply	+48V/10mA max			
Frequency response (20 ~ 20kHz)	±0.3dB			
Maximum level	+18dBu			
THD+N	<-94dB @4dBu			
Input dynamic range	110dB			
Output dynamic range	112dB			
Channel isolation at 1kHz	108dB			
Input impedance (balanced connection)	5.4KΩ			
Output impedance (balanced connection)	600Ω			
System delay	<3ms			
Power supply	AC110~240V, 50Hz/60Hz			
Dimensions (W x D x H)	482x260x45mm			
Weight with packaging	4 KG			



LM-W

Platine murale de contrôle

Programmable IP/PoE wall control panel to control the volume and the choice of sources remotely.

- Gain control / Mute / Presets / Matrixing
- Built-in or surface-mounted



RM-8

8 zones remote microphone for DNM-88 & DNM-88D

- Balanced output audio signal
- Input : 12VDC
- RS-485



DW-BT

Platine murale Dante et Bluetooth

Converts analog audio signals, Bluetooth into digital Dante signals.

- PoE power supply.



W-TAB10

10'' touch screen

Permet de contrôler le volume, la sélection de la source sonore, lancer des Presets, etc.

- 10/100Mb Ethernet network connection
- POE or external power supply
- 1280x800 px resolution, 16:9 format

SUPPORT VESA TABLE : adjustable desk standfor W-TAB10



SUPPORT VESA MURAL : wall mount or rackfor W-TAB10



PX-8000 8 OdB inputs Matrix - 4 Micro inputs



- Audio Matrix for the sound system and emergency messages broadcasting
- Priorities management
- Loudspeaker for monitoring
- Numerous audio inputs (Music, Microphone station, local audio Source, Microphone)
- Easy Installation without configuration of ID
- Message recording from a microphone and playback of the message activation by dry contact zone after zone
- Communication via Long distance special RS-422
- Selectable chimes Broadcasting (PRE/POST announcement)
- Control of the tone over the outputs (Bass/ Treble)
- Display of input and output levels

Model	PX-8000
Audio output	0dB (balanced)
Audio input	-50dB (balanced) -10dB (balanced)
Bandwidth	BGM: 60Hz ~ 15kHz MICRO: 100Hz ~ 10kHz
Signal / Noise	BGM > 75dB - MICRO > 65dB
T.H.D	BGM < 0.05% / MICRO < 0.05%
Priorities management	MICRO station > DRP > RMI > RM2 > RM3 > RM4 > LM-8000 > BGM Main
Power source	100-120VAC or 220-240VAC 50/60Hz
Consumption power	60W
Dimensions (WxHxD)	482 x 132 x 380mm · 3U
Weight	7.5kg

- MIC Station for use with PX-8000
- Convenient installation and construction without need of ID setting
- Selection of various chime broadcasting for MIC (PRE/POST)
- Priorities management (RM1>RM2>RM3>RM4)
- Internal monitor speaker
- RS-422 Communication for long distance
- Power source: 24VDC, 300mA (supplied from PX-8000)
- Dimensions (WxHxD): 200 x 70 x 206mm
- Weight: 1.5kg



- Local animation deck with audio In
- For use with PX-8000
- Convenient installation and construction without need of ID setting
- Remote volume control and selection of BGM
- Independent local MIC and BGM broadcasting
- Jut out mounting, classic electric enclosure
- RS-422 Communication for long distance
- Dimensions (WxHxD): 70 x 114 x 52mm
- Embedding dimensions: 50 x 70mm
- Weight: 130g

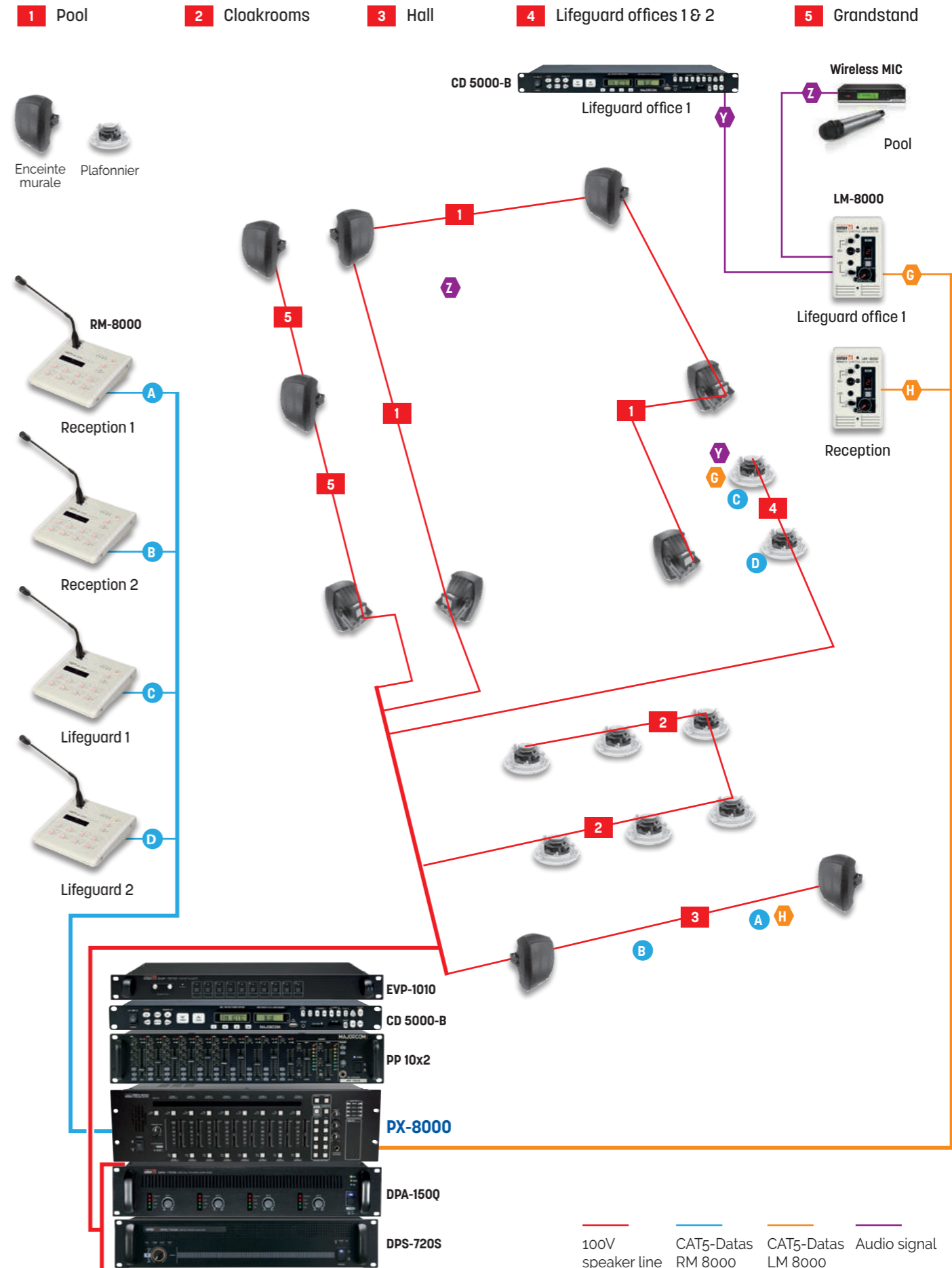

Mixer amplifiers

MA-106 / MA-110

60W / 100W mixer amplifiers



MA-110

- MA-106 / MA-110 are compact 1U size PA amplifiers with rated power of 60W and 100W which are ideal for small rooms such as conference rooms, function rooms, restaurants and cafes.
- With their exclusively high-efficiency amplification circuitry, the MA-106 / MA-110 are reliable, lightweight and low heat.
- The volume of INPUT1-3 can be controlled separately.
- The input signal from INPUT1-3 is indicated making verification of the operating status of each channel available.
- Auto Sleep Mode: Without any input signal for more than 5 minutes, it will automatically enter Auto Sleep Mode, and once the input signal is input again, it will wake up within 0.5 seconds.
- Tone controller (Bass / Treble).
- Outdoor mute control: The mute function can be controlled outdoors and can also be linked to an emergency broadcast.
- Additional function such as microphone phantom power, TEL IN are possible.

Model	MA-106	MA-110
RMS Power	60W	100W
Speaker output/impedance	15.5V/4Ω, 25V/10.5Ω, 70V/82Ω, 100V/167Ω	20V/4Ω, 70V/49Ω, 100V/100Ω
Input sensitivity	INPUT 1	-50dB
	INPUT 2 (MIC)	-50dB
	INPUT 2 (LINE)	-10dB
	INPUT 3	-10dB
	TEL IN	0.775V
Bandwidth ±3dB	80 to 15,000Hz	80 to 18,000Hz
Signal / Noise	INPUT 1, 2	> 60dB
	INPUT 3, TEL IN	> 70dB
Tone Control	BASS (100Hz)	±12dB
	TREBLE (10kHz)	±12dB
Operating temperature	-10°C ~ +40°C	
Power consumption	24W	30W
Power source	220~240VAC, 50/60Hz	
Dimensions (WxHxD)	300 x 44 x 230mm	
Weight	3kg	

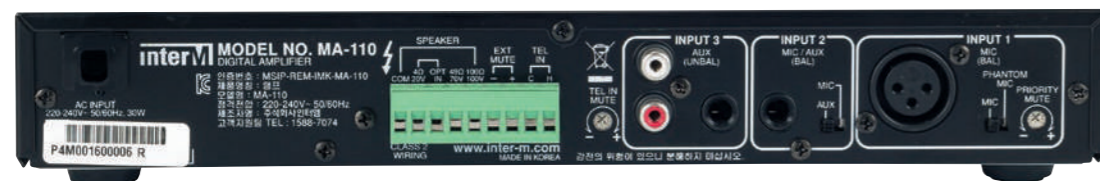

Rear panel



BKT-MA106: set of brackets for racking MA-106 & MA-110 amps-preamps in 19" racks (optional)

Mixer amplifiers

PU-103 / PU-106 / PU-112

30W / 60W / 120W mixer amplifiers with USB player



PU-112

- The PU-103/106/112 series (with USB player) is compact in design that can be easily used in small spaces such as classrooms, meeting rooms, training centers, restaurants, shops... to allow you to broadcast your music or microphone sources.
- The three power models 30W / 60W / 120W can be used in both high impedance (100V / 70V) and low impedance (4Ω).
- They also have a priority BGM input, a super priority TEL IN input, two line inputs and a contact input for the sound cutoff.
- Simply broadcast your music with the USB player on the front panel.
- Volume controls and tone adjustment on the front panel.
- SMPS Power Supply

Model	PU-103	PU-106	PU-112
Puissance RMS	30W	60W	120W
Output impedance	15.5V/8Ω, 70V/166Ω, 100V/333Ω	21.9V/8Ω, 70V/82Ω, 100V/167Ω	21.9V/4Ω, 70V/40.83Ω, 100V/83.33Ω
Input sensitivity / Impedance	MIC (BALANCED)	-60dBV / 2kΩ	
	LINE (BALANCED)	-20dBV / 2kΩ	
	RCA (UNBALANCED)	-20dBV / 20kΩ	
	JACK 6.35 (UNBALANCED)	-20dBV / 2kΩ	
	TEL IN (Balanced)	0dBV/5kΩ	
Bandwidth ±3dB	300 to 12,000		
Signal / Noise	MIC	55dB	
	RCA, JACK 6.35	55dB	
	LINE, TEL IN	55dB	
Tone control	BASS (200Hz)	±10dB	
	TREBLE (15kHz)	±10dB	
THD+B 1kHz (1/3Pwr @8Ω)	1%		
Operating temperature	-10°C ~ +40°C		
Power consumption (1/8 W)	20W	35W	
Power source	120-240VAC, 50/60Hz		
Dimensions (WxHxD)	300 x 44 x 230mm		
Weight	2,82kg	3,18kg	



Rear panel



BKT-MA106: set of brackets for racking PU-103/PU-106/PU-112 amps-preamps in 19" racks (optional)

PA-212 / PA-224: 120W / 240W Class D amplifiers with USB player



PA-224

- High-Z (100V/70V) and low-Z (8Ω/4Ω)
- Multiple inputs (3 MIC/LINE inputs, 2 LINE inputs, 2 stereo/LINE inputs, 1 TEL IN, 1 usb) and a feature for controlling the volume of each channel
- EXT in and MIX OUT
- Displaying input signal led by channel and output led level
- Tone (bass/treble) controlling
- 5 switches (zone selection switch)
- Broadcasting in priority
- TEL IN > INPUT 1 > INPUT 2 = INPUT 3 = INPUT 4 = INPUT 5 = INPUT 6
- External mute and external chime
- Chime and siren

Model	PA-212	PA-224
Power RMS	120W	240W
Output Impedance	31V/8Ω, 70V/41Ω, 100V/84Ω	31V/4Ω, 70V/21Ω, 100V/42Ω
Input sensitivity / Impedance	MIC (BALANCED)	-70dBu / 2kΩ
	LINE (BALANCED)	-20dBu / 2kΩ
	RCA (UNBALANCED)	-20dBu / 2kΩ
	JACK 3.5 (UNBALANCED)	-10dBu / 10kΩ
	TEL IN (BALANCED)	-20 ~ 0dBu/10kΩ
	EXT IN (BALANCED)	0dBu / 20kΩ
	MIX OUT (BALANCED)	0dBu / 10kΩ
Bandwidth (1W, ±3dB, Low-Z)	80 to 17,000Hz	
Signal / Noise	MIC	50dB
	RCA, JACK 3.5	70dB
	LINE, TEL IN	70dB
Tone Control	BASS (200Hz)	±10dB
	TREBLE (15kHz)	±10dB
THD+N Rated Power (1kHz)	< 1%	
Operating Temperature	-10°C ~ +40°C	
Consumption (1/8 W)	20W	35W
Power source	220V, 230V, 240VAC, 50/60Hz	
Dimensions (WxHxD)	420 x 88 x 318,7mm	
Weight	2,82kg	3,18kg



RM-05A: 5-zone selective call Mic station for PA-212/PA-224

Station fitted with a high-quality electret microphone hose equipped with a level adjustment and a LEC volume unit meter.

- Comes with a 2m-cord (7 pairs + display) SubD15 connector.
- Hose length: 400mm
- Dimensions: 195 x 60 x 205mm
- Weight: 1.2kg



Rear panel

BKT-A120: Set of brackets for racking PA-212 / PA-224 amplifiers (optional)

- BKT-A120 are brackets for fixing PA series amps-preamps in 19" racks.



PM-236 / PM-248 / PM-260: 360/480/600W Class D amplifiers with USB player



PM-248

- High-Z (100V/70V) and low-Z (8Ω/4Ω)
- Multiple inputs (3 MIC/LINE inputs, 2 LINE inputs, 2 stereo/LINE inputs, 1 TEL IN, 1 usb) and a feature for controlling the volume of each channel
- EXT in and MIX OUT
- Displaying input signal led by channel and output led level
- Tone (bass/treble) controlling
- 5 switches (zone selection switch)
- Broadcasting in priority
- TEL IN > INPUT 1 > INPUT 2 = INPUT 3 = INPUT 4 = INPUT 5 = INPUT 6
- External mute and external chime
- Chime and siren

Model	PM-236	PM-248	PM-260
Power RMS	360W	480W	600W
Output Impedance	38V/4Ω, 70V/13.6Ω, 100V/27.7Ω	44V/4Ω, 70V/10.2Ω, 100V/20.8Ω	70V/8.1Ω, 70V/8.1Ω, 100V/16.6Ω
Input sensitivity / Impedance	MIC	-60dBV / 2kΩ balanced	
	LINE	-20dBV / 2kΩ balanced	
	RCA	-20dBV / 20kΩ unbalanced	
	JACK 3.5	-20dBV / 2kΩ unbalanced	
	TEL IN	-20~0dBV / 40kΩ balanced	
	EXT IN	0dBV / 40kΩ balanced	
	MIX OUT	0dBV balanced	
Bandwidth (1W, ±3dB, Low-Z)	80 to 15,000Hz		
Signal / Noise	MIC	>50dB	
	RCA, JACK 3.5	>50dB	
	LINE, TEL IN	>70dB	
Tone Control	BASS (100Hz)	±10dB	
	TREBLE (10kHz)	±10dB	
THD+N Rated Power (1kHz)	< 1%		
Operating Temperature	-10°C ~ +40°C		
Consumption (1/8 W)	115W	125W	145W
Power source	220-240VAC 50/60Hz		120-240VAC, 50/60Hz
Dimensions (WxHxD)	420 x 88 x 318,7mm		
Weight	5,1kg	5,27kg	



RM-05A: 5-zone selective call Mic station for PM-236/248/260

Station fitted with a high-quality electret microphone hose equipped with a level adjustment and a LEC volume unit meter.

- Comes with a 2m-cord (7 pairs + display) SubD15 connector.
- Hose length: 400mm
- Dimensions: 195 x 60 x 205mm
- Weight: 1.2kg



Rear panel

BKT-A120: Set of brackets for racking PM-236/248/260 amps (optional)

- BKT-A120 are brackets for fixing PM series amps-preamps in 19" racks.



PAM-312 / PAM-336 / PAM-348 : 120/360/480W amps-preamps, 6 MIC SYM / AUX inputs



- The new generation of PAM amps-preamps has been completely redesigned with Class-D amplification, an improved audio processing, simplified and multi-format connectivity (XLR/Euroblock/RCA/Jack 6.35).
- You can select different source modules that can be integrated on the front panel such as FM Tuner, CD/USB, Bluetooth/USB, CD/USB/FM Tuner (the integration of the module no longer requires opening the PAM: simply insert it into the drawer on the front panel).
- Ideal all-in-one and compact device for applications such as shops, stores, schools, sports hall, restaurants...
- 6 inputs including 2 priority inputs + the TEL IN input super priority.
- Various inputs and connectors: MIC / MIC + Phantom / Line, RCA, Euroblock.
- 5 Speaker line outputs that can be activated or not on the front panel, ideal for selective calling via the MICRO RM-05 desk in 5 Zones.
- Multi-level priority broadcasting: (EM> TEL IN> RM, INPUT 1& 2> INPUT 3 to 6 > modules).
- Tone adjustable according to the operating environment (BASS / TREBLE).
- Chime, EXT IN input for mixer or external preamplifier and MIX OUT for external amplifier (Booster).
- Phantom power supply.
- Can be adapted for a rack-mounting. The PAM is delivered with brackets.

Integrable modulation sources

PAM-BTU: Bluetooth & USB



- Bluetooth wireless audio and USB player.
- OLED display.
- Supported codecs for USB: MP3, WMA.
- AVRCP supported to control the Bluetooth audio remotely.
- Dedicated volume control.
- Operating power: DC 24V (from amplifier).

PAM-CDU: CD & USB



- Compact Disc and USB player
- OLED display
- Supported codecs for USB: MP3, WMA
- Dedicated volume control
- Operating power: DC 24V (provided by amplifier).
- Weight: 0.88kg

PAM-FMT: Tuner FM



- FM radio tuner.
- OLED display.
- Frequency band: 87.5-108.0MHz.
- Auto scan with 5 presets.
- Dedicated volume control, Mute.
- Operating power: DC 24V (from amplifier).
- Weight: 0.49kg

PAM-MPM4: CD/USB/Tuner



- Module CD-DA / CD-R / CD-RW / MP3 / WMA / USB / DRP 1GB / TUNER AM FM
- Features: Random play, track scanning, time counting, loop, previous and next track, track search, automatic radio station search, 40 recordable stations, USB playing, copy from USB or CD to DRP (1GB data storage memory that preserves the CD mechanism).

Model	PAM-312		PAM-336	PAM-348
Power RMS	120W		360W	480W
Output Impedance	70V/41Ω, 100V/84Ω		70V/13.6Ω, 100V/27.7Ω	70V/10.2Ω, 100V/20.8Ω
Input sensitivity / Impedance	CH1 ~ 3	MIC	-60dBV / 2kΩ (Balanced)	
		LINE	-20dBV / 2kΩ (Balanced)	
	CH4 ~ 5	LINE	-20dBV / 30kΩ (Balanced)	
		LINE	-20dBV / 20kΩ (Unbalanced)	
	TEL IN	-20dBV-0dBV / 40kΩ (Balanced)		
EXT IN	0dBV / 40kΩ (Balanced)			
Bandwidth (1W, 0 ± 3dB)	80 to 15,000Hz			
Signal / Noise (S / B, A-WTD)	MIC	55dB		
	LINE	70dB		
Tone control	BASS (100HZ)	±10dB		
	TREBLE (10KHZ)	±10dB		
THD (@ 1kHz)	< 1%			
Operating temperature	-10°C ~ +40°C			
Consumption (1/8W)	50W	97W	115W	
Power source	AC 120V, 50/60Hz or AC 220-24 V, 50/60Hz			
Dimensions (WxHxD)	420 x 132 x 358mm			
Weight (w/o modules)	7.26kg	6.93kg	7.16kg	

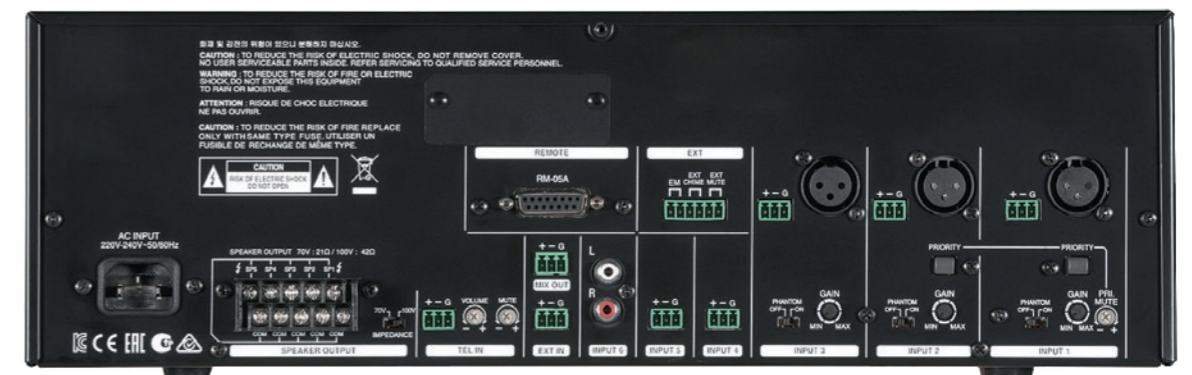

Rear panel

BKT-PA4000A : set of 19" mounting brackets for PAM (included)

- Brackets for fixing PAM series amps-preamps in 19" racks.



RM-05A: 5-zone selective call Mic station for PAM-312/336/348

- Station fitted with a high-quality electret microphone hose equipped with a level adjustment and a LEC volume unit meter.
- Comes with a 2m-cord (7 pairs + display) SubD15 connector.
- Hose length: 400mm
- Dimensions: 195 x 60 x 205mm
- Weight: 1.2kg

Analog amp-preamp

MX 30

30W analog amp-preamp



- 30W compact device with low impedance and 100V line outputs.
- It is fitted with a priority balanced microphone input that can be remote controlled with dry contact, an unbalanced microphone input, an AUX input and a CD input.
- A 3-band equalizer provides a perfect equalization of the tone.
- 220V power source.

Model	MX 30
RMS Power	30W
Bandwidth	100 - 20,000Hz
Impedance	166Ω / 70V - 333Ω / 100V
T.H.D	< 2.5%
Bass/Treble equalization	+/- 10dB
Signal / Noise	> 60dB
Inputs sensitivity	MIC: 1mV - AUX: 200mV - CD: 500mV
Power source	AC 220 - 240V 50/60Hz
Dimensions (WxHxD)	270 x 90 x 260mm
Weight	4.25kg



Rear panel



BKT-MX30/60 : set of brackets for racking the MX-30 amp-preamp in 19" racks (optional)

Compact analog amp-preamp with source

MX 60T

60W compact amp-preamp with Tuner AM/FM, USB port



- 60W compact device with low impedance and 100V line outputs.
- It includes a AM/FM tuner with a 20-station memory and a USB port to play MP3 files contained in a USB key.
- It is fitted with a priority balanced microphone input that can be remote controlled with dry contact, an unbalanced microphone input, an AUX input and a CD input.
- A 3-band equalizer provides a perfect equalization of the tone.

Model	MX 60T
RMS Power	60W
Output voltage and impedance	15V/4Ω · 22V/8Ω · 31V/16Ω 70V/82Ω · 100V/166Ω
Bandwidth	100 to 20,000Hz
Signal / Noise	> 60dB
T.H.D	< 2.5%
Inputs sensitivity	MIC 1: 1mV/600Ω - phoenix terminal / MIC 2: 1mV/600Ω - Jack 6.35 AUX: 200mV/50kΩ - RCA / CD: 500mV/50kΩ - RCA
Tuner AM/FM	FM: 87.5 to 108MHz, AM: 522 to 1611kHz
Bass/Treble equalization	150Hz, 1kHz and 6kHz +/-10dB
USB port	playback MP3 files contained in a USB key
Output	music on hold odB
Power source	230VAC · 50/60Hz
Dimensions (WxHxD)	270 x 75 x 230mm
Weight	5kg



Rear panel

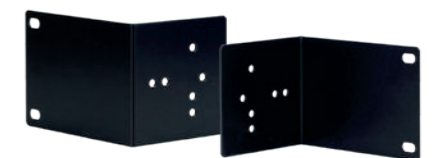

BKT-MX30/60: set of brackets for racking the MX 60T amp-preamp in 19" racks (optional)

AFM: outdoor movable radio antenna

- Lets you pick up FM radio stations when there is no reception inside the sound area.



Analog amp-preamp

MX 3120

120W analog amp-preamp



- Rack-mounting amp-preamp, 120W RMS 100V line
- 2 balanced Mic inputs with priority on DIN 5 poles
- Mic1 (dry contact) > Mic2 (dry contact) > Mic/AUX3, AUX4, AUX5
- 3 unbalanced Mic or Line inputs
- Chime 2 tone controlled by dry contact

- Bass and treble tone control on front panel
- BOOSTER output
- "Music and speech" output or "speech only" output
- 220V power supply and 24VDC
- Comes with brackets



Model	MX 3120
RMS Power	20W
Bandwidth	50 to 18,000Hz
Impedance	41Ω / 70V - 83Ω / 100V
T.H.D	< 1%
Bass/Treble equalization	+/- 10dB
Signal / Noise	> 60dB
Inputs sensitivity	MIC: 0.8mV - AUX: 200mV - CD: 500mV
Chime	2 tone
Power source	220-240VAC 50/60Hz and 24VDC
Dimensions (WxHxD)	428 x 88 x 268mm
Weight	10.2kg



Rear panel

Pre-amplifier-Mixer

PP 10x2

10 inputs/2 outputs preamplifier-mixer



- Rack-mounting preamplifier fitted with 10 inputs and 2 outputs. Each input has a display of modulation presence.
- 10 inputs correspond to the following:
 - 6 Mic/Line inputs (CH1 to CH6) which 2 priorities and fitted with a Phantom power supply.
 - 4 Line inputs (CH7 to CH10).
 - 1 top priority 0dB input.

- Trim and tonal setting on each input (except CH7 to CH10).
- 2 outputs with 2-band equalization. A bar graph on each output allows to display the modulation level.
- Record output, needful for many applications.
- Possibility of emergency power supply of 24VDC in case of power failure.

Model	PP 10x2
Bandwidth	20 to 20,000Hz
Input sensitivity	6 Mic/Line input balanced -60/0dB 4 unbalanced Line inputs 0dB 1 top priority input 0dB 1 record output 2 balanced outputs 0dB
T.H.D	< 0.2%
Input equalizer	±12dB @ 80Hz, 2.5kHz and 12kHz
Signal / Noise	> 70dB
Power source	230VAC - 50Hz / 24VDC / 16W
Dimensions (WxHxD)	482 x 88 x 320mm · 2U
Weight	5.3kg



Rear panel

PP-6214**10 inputs/2 outputs preamplifier-mixer**

- The PP-6214 is a 2-output Pre-amplifier / Mixer which allows any of the unit's 10 input signals to be routed to Output 1, Output 2 or both.
- It is ideal for dual zone public address or audio visual installed applications such as factories, leisure centres, hotels and general PA systems.
- It has 8 Mic inputs (CH 1 to CH 8), 7 Line inputs (CH 2 to CH 8), 2 Stereo inputs and 2 Priority input.
- Phantom power (18v block switched) can supply 8 Mic inputs and a 3-band equalizer per output allows you to make correction independently on the 2 outputs.
- It can be supplied by a 24VDC backup power supply.

Model	PP-6214
Inputs	MIC (CH 1 to CH 8): XLR -60dB / 600Ω - LINE (CH 2 to CH 8): Jack mono 6.35mm -30dB / 10kΩ STEREO: RCA -30dB / 10kΩ
Outputs	XLR +4dBm / 600Ω
REC outputs	-6dB / 10kΩ
Bandwidth	20Hz - 20kHz
Phantom	MIC 1 to 8: 18VDC
Power source	230VAC 50Hz - 24VDC
Dimensions (WxHxD)	482 x 88 x 280mm · 2U
Weight	5.5kg



Rear panel

Class-D digital amps - 100V - 24VDC

DPA amps technical specifications

DPA-50E / DPA-150Q / DPA-300Q

8 x 50 / 4 x 150 / 4 x 300W Class-D digital amps - 100V - 24VDC



DPA-50E



DPA-150Q / 300Q

- The DPA amps are multiple Class-D, 2U digital amps with efficiency better than 90% for less heat dissipation, noise, and weight compared to traditional analog amps.
- The line features 3 models quadruple and eightfold amps from 400 to 1200W.
- They include 2 audio inputs, including one priority input to cut the current program so you can broadcast a priority message by dry contact, for example.
- Front-panel LEDs let you see amp status instantly.
- These amplifiers are fitted with a 24VDC supply terminal block for use on booster batteries.

Secure operation through AC/DC dual power

DPA have a dual AC/DC power supply and the 24VDC can be provided by the backup power supply in case of an emergency such as a blackout. DC power is a standby power supply that operates independently. The AC/DC failover is automated and requires no action.

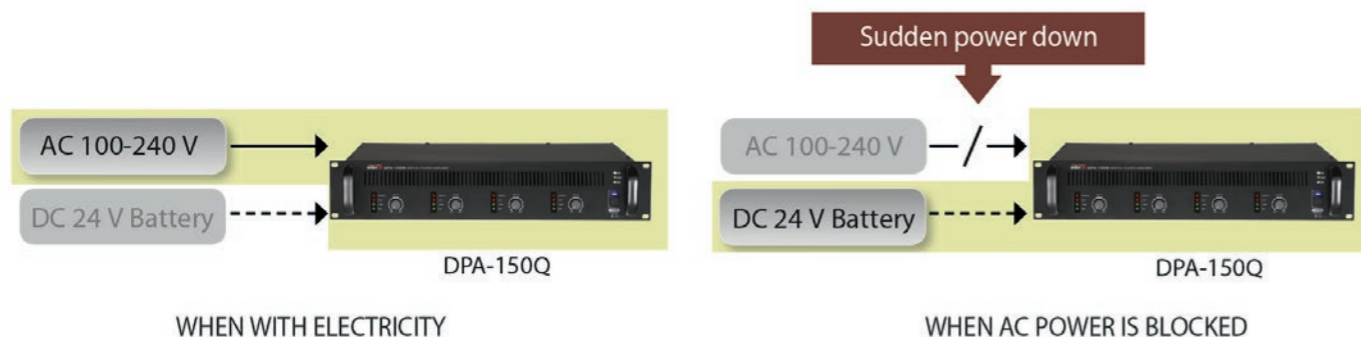

High quality sound of high S/N and low THD

DPA are high quality amplifier with a S/N higher than 100dB and THD less than 0.2%. Thus this amplifier are suitable for large places such as shopping malls, department stores, places where high quality music listening and voice reproduction are required.



Remote AC power control function to ON/OFF

With the AC POWER REMOTE terminal on the rear panel, DPA power can be controlled remotely. If contact closure is input to the AC POWER REMOTE terminal when DPA-150Q is OFF, the device turns on and if contact closure is inserted when ON, the device turns OFF.

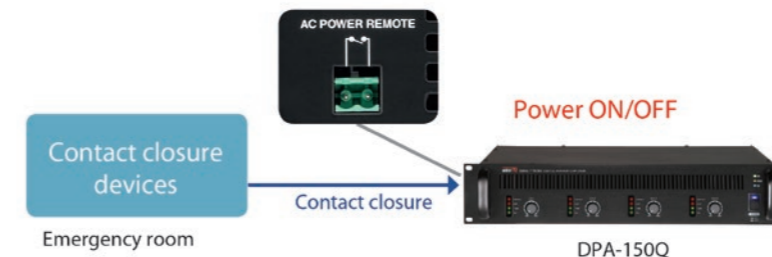

Priority

Automatic emergency broadcasting is available using priority function of PA-150Q in emergency situations. When contact closure is inserted to PRIORITY terminal on the rear panel, signals input to the PRIORITY terminal are output before the ones entered to PGM INPUT terminal.

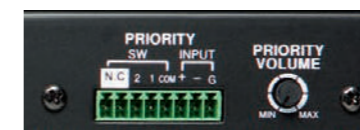

Stability guaranteed with perfect protection circuits



Stability of the device is guaranteed with OVP (Over-Voltage Protection) function which perceives and blocks when in/output voltage is higher or lower than the settled voltage range, UVP (Under-Voltage Protection) and overcurrent protection function.

Model	DPA-50E	DPA-150Q	DPA-300Q
RMS Power	8 x 50W	4 x 150W	4 x 300W
Bandwidth	80 to 20,000Hz	50 to 20,000Hz	30 to 20,000Hz
100V impedance	200Ω	66.7Ω	33Ω
70V impedance	98Ω	32.7Ω	16Ω
Input sensitivity		1V/10kΩ	
THD	<1%	<0.2%	<1%
Signal / Noise	95dB	>100dB	95dB
Operating temperature	-10°C ~ 40°C		
Power source	AC 220 - 240V · 50/60Hz - DC 24V		
Dimensions (WxHxD)	482 x 88 x 367mm		
Weight	6.8kg		



DPA-50E rear panel



DPA-150Q / 300Q rear panel

Class-D digital amps - 100V - 24VDC

DPS-240S / DPS-360S / DPS-480S / DPS-720S

Class-D 240W / 360W / 480W / 720W - 100V - 24VDC digital amps



DPS-720S

- This DPS Serie includes multiple Class-D, 2U digital amps with efficiency better than 90% for less heat dissipation, noise, and weight compared to traditional analog amps.
- The line features a number of single channel models ranging from 240 to 720W.
- These amps include 2 audio inputs, including one priority input to cut the current program so you can broadcast a priority message by dry contact, for example.
- Front-panel LEDs let you see amp status instantly.
- Fitted with a 24VDC supply terminal block for use on booster batteries.

Model	DPS-240S	DPS-360S	DPS-480S	DPS-720S
RMS Power	240W	360W	480W	720W
Bandwidth (1W, ± 3 dB)	60 to 20,000Hz			
100V impedance	66,7 Ω	27,8 Ω	20,8 Ω	13,9 Ω
70V impedance	20,4 Ω	13,6 Ω	10,2 Ω	10,2 Ω
Input sensitivity	1V/10k Ω			
THD (AES17, 1/8 Power)	< 0,5%			
Signal / Noise	> 100dB			
Operating temperature	-10°C ~ 40°C			
Power source	220 - 240VAC · 50/60Hz - 24VDC			
Consumption	130W		250W	
Dimensions (WxHxD)	482 x 88 x 371mm		482 x 88 x 424mm	
Weight	6,9kg		7,96kg	



Rear panel

Class-D digital amps - 100V - 24VDC

DPS-240D / DPS-360D / DPS-480D

Class-D 2 x 240W / 2 x 360W / 2 x 480W - 100V - 24VDC digital amps



DPS-480D

- This DPS Serie includes multiple Class-D, 2U digital amps with efficiency better than 90% for less heat dissipation, noise, and weight compared to traditional analog amps.
- The line features a number of single channel models ranging from 240 to 720W.
- These amps include 2 audio inputs, including one priority input to cut the current program so you can broadcast a priority message by dry contact, for example.
- Front-panel LEDs let you see amp status instantly.
- Fitted with a 24VDC supply terminal block for use on booster batteries.

Model	DPS-240D	DPS-360D	DPS-480D
RMS Power	2 x 240W	2 x 360W	2 x 480W
Bandwidth (1W, ± 3 dB)	60 to 20,000Hz		
100V impedance	41,6 Ω	27,7 Ω	20,8 Ω
70V impedance	20,4 Ω	13,6 Ω	10,2 Ω
Input sensitivity	1V/10k Ω		
THD (AES17, 1/8 Power)	< 0,5%		
Signal / Noise	> 100dB		
Operating temperature	-10°C ~ 40°C		
Power source	220 - 240VAC · 50/60Hz - 24VDC		
Consumption	130W	250W	
Dimensions (WxHxD)	482 x 88 x 371mm	482 x 88 x 424mm	
Weight	7,4kg	8,25kg	8,23kg



Rear panel

Gamme M-AD1

**Class D multichannel digital power amplifiers
150W/250W/500W**



- The M-AD1 range offers a wide choice of 100V line class-D digital power amplifiers.
- Available in 9 single- or multi-channel configurations : 1, 2 or 4 channels.
- Total power from 150 to 2000W with 3 different channel powers: 150W / 250W / 500W.
- It offers advantages in terms of energy efficiency, heat dissipation and space saving.
- Switching power supply in combination with class D amplifier stage permits less weight and energy efficient.
- The integrated ventilation system protects against overheating.
- Front panel LEDs provide instant control of amplifier status.
- Easy to use, basic settings are on the front panel : volume, bass and treble control.
- Each amplifier has 2 audio inputs, including an input to mute the current broadcast by dry contact and and a 100V output that can be switched to 70V.

Model	M-AD1-1150	M-AD1-1250	M-AD1-1500	M-AD1-2150	M-AD1-2250	M-AD1-2500	M-AD1-4150	M-AD1-4250	M-AD1-4500
Power	1 x 150W	1 x 250W	1 x 500W	2 x 150W	2 x 250W	2 x 500W	4 x 150W	4 x 250W	4 x 500W
Nominal Power consumption	180W	280W	560W	360W	565W	1120W	720W	1130W	2240W
1/8 Pmax Pink noise Consumption	31W	44W	93W	58W	100W	185W	120W	190W	370W
INPUT									
Input sensitivity	0 dBu								
Input type	Balanced								
Connectivity	Combo : XLR + 6,35mm Jack								
OUTPUT									
Voltage	100V/70V (dip switch selection)								
Bandwidth	20Hz à 20kHz (-3dB @ -10dB ref rated output)								
Distorsion	< 0,5% @ rated output, 1kHz								
S/N ratio	> 80dB								
Connectivity	2 pts removable terminal block (pitch 5,08mm)								
OTHER									
Mute input	Dry contact								
Connectivity	2 pts removable terminal block (pitch 3,81mm)								
Power supply	Mains: 110V-265V AC 50Hz/60Hz								
Weight	3,6 kg	4 kg			6,5 kg				
Dimensions (LxWxD) mm	422 x 328 x 44	422 x 328 x 88	422 x 328 x 44	422 x 328 x 88					

PA-6312 / PA-6336 / PA-6348

120/360/480W analog power amps - 100V - DC 24V - 8/4Ω



- Models are available in a variety of 120, 360 and 480W output power in 8/4Ω low impedance and in 70/100V line.
- They are the installer's choice for sound reinforcement, background music, paging, and public address systems.
- Equipped with low distortion and low noise electronic circuits, it offers a high signal-to-noise ratio.
- The PA 6300 series offers outstanding versatility, long term reliability, and a remarkable value for any application.
- 400Hz HPF (High Pass Filter)
- -12dB gain adjustment
- Output level indicators
- Thermal Protection

Model	PA-6312	PA-6336	PA-6348
RMS Power (@ THD 1%,1kHz)	120W	360W	480W
Output voltage and impedance	4Ω / 22V 41Ω / 70V 83Ω / 100V	4Ω / 38V 13.6Ω / 70V 27.8Ω / 100V	4Ω / 43.8V 10.2Ω / 70V 20.8Ω / 100V
Bandwidth (+1/-3dB)	70 to 18,000Hz		
T.H.D	< 1%		< 5%
Signal / Noise	> 95dB		> 90dB
High-pass filter	-3dB @ 400Hz		
Input impedance sensitivity	1 V/10kΩ balanced		
Adjustable input	-12dB @ 0dB		
Cooling	Fan		
Operating Temperature	-10°C ~ +40 °C		
Relative humidity	~ 95%		
Power Consumption	130W	450W	600W
Power source	100-120VAC ou 220-240VAC ; 50/60Hz, 24VDC		
Dimensions (WxHxD)	482 x 132 x 280mm · 3U		
Weight	14kg	19kg	22kg



Rear panel

PA-2312**2 x 120W forced-ventilated power amp - 100V - DC 24V - 8/4Ω**

- This amplifier is a forced-ventilated 120W RMS power per channel dual unit.
- The high-pass dual filter protects loudspeakers from any bass frequency excess.
- The balanced input enables to reduce hum produced by long input cables and problems of ground loop.
- The Adjustable Gain located at the rear of the appliance enables to control the input gain from -12dB to 0dB.
- Continuous power supply terminals for booster batteries in case of power failure.

Model	PA-2312
RMS Power (@ THD 1%,1kHz)	2 x 120W
Output voltage and impedance	23V - 4Ω 70V - 41Ω 100V - 82Ω
Bandwidth	40 to 20,000Hz
T.H.D	< 1%
Signal / Noise	> 95dB
High-pass filter	- 6dB @ 400Hz
Input impedance sensitivity	1V / 10kΩ balanced
Adjustable input	-12dB @ 0dB
Cooling	Fan
Operating Temperature	0°C - +40 °C
Relative humidity	~ 95%
Power Consumption	480W
Power source	120/240VAC · 24VDC
Dimensions (WxHxD)	482 x 132 x 280mm · 3U
Weight	20kg



Rear panel

DPN-240S / DPN-240D / DPN-240Q / DPN-480S / DPN-480D 240 / 2x240 / 4x240 / 480 / 2x480W digital amplifiers over IP network



FEATURES

- The DPN series offers a wide choice of single or multi-channel power ratings, in line 70V/100V with galvanic isolation.
- The amplifiers are EN 54-16 certified and designed to work with the EVAMATRIX security PA system.
- All system components are fully IP networked (audio & control) using Dante® technology.
- Dual primary and secondary network connection for total redundancy.
- Low power consumption, low heat dissipation for energy savings and gains in battery capacity and backup power.
- Complete supervision of the operation of the amplifiers and all connections. Faults are reported locally on the EVAMATRIX and archived.
- Control and supervision of the loudspeaker lines WITHOUT audio interruption with the EOL-20 end of line element
- Control and supervision of the network link with audible and visual indication on the amplifier unit and EVAMATRIX.
- Integrated backup amplifier channel dynamically assignable from the EVAMATRIX web interface with automatic switchover
- 2 A/B outputs on each amp channel. The 2 outputs are supervised and individually disabled in case of failure.
- Audio over IP, Dante® and AES67 compatible; audio sample rate is of 48kHz with a sample size of 24 bits.
- High signal to noise ratio, wide audio bandwidth, very low distortion and crosstalk.
- DSP, digital signal processing on all amp channels from the EVAMATRIX control unit web server, including equalization, levels to optimize and customize the sound in each speaker zone.



DPN-240S / 480S



DPN-240D / 480D



DPN-240Q

SEVERAL POWERS FROM SINGLE TO QUADRUPLE CHANNEL

1 x 240W: **DPN-240S** 2 x 240W: **DPN-240D** 4 x 240W: **DPN-240Q**
 1 x 480W: **DPN-480S** 2 x 480 W: **DPN-480D**

- Local UGA and dry contact inputs monitored for triggering of alarm conditions, alarm... Ideal for decentralized systems.
- Dry contact inputs for local feedback of third party faults (CMSI, EAE, GTC...) in case of decentralized use.
- Local fault outputs customizable as desired and by alarm zone.
- An additional local analog audio input on each DPN amplifier that will be converted and made available to the entire EVAMATRIX system.
- The system integrates the SNMP V2c protocol (Simple Network Management Protocol) which allows a management and monitoring software to report any type of fault and status of the sound equipment.
- The system incorporates seamless security (HTTPS, TLS1.2, SHA256, SSL, AES256 encryption and elliptic curve cryptography).

Model	DPN-240S	DPN-240D	DPN-240Q	DPN-480S	DPN-480D
Power source	220 - 240VAC, 50/60Hz, 24VDC				
Power	1 x 240W RMS @ 70V/100V Class D Load Min 41.6Ω, Capacity Min 0.01uF	2 x 240W RMS @ 70V/100V Class D Load Min 41.6Ω, Capacity Min 0.01uF	4 x 240W RMS @ 70V/100V Class D Load Min 41.6Ω, Capacity Min 0.01uF	1 x 480W RMS @ 70V/100V Class D Load Min 41.6Ω, Capacity Min 0.01uF	2 x 480W RMS @ 70V/100V Class D Load Min 41.6Ω, Capacity Min 0.01uF
Consumption	Max	313W	595W	1 254W	583W
	1/8 power	135W	140W	280W	135W
	Standby	58W	75W	89W	59W
Frequency response	20Hz - 20kHz @ (±3dB @ 1W)				
Signal / Noise	> 91dB (20kHz LPF, A-WTD)				
T.H.D	< 0.45% at 1kHz Power rating				
Audio input	Type: Balanced Euro terminal / Input sensitivity: 5dBV (1.78 Vrms)				
Ethernet (LAN)	RJ45, TCP/IP protocol 100/1000 Base-T				
Extension	Output to EVAMATRIX on RJ45 (Dante®) - Input from EVAMATRIX on RJ45 (Dante®) CAT5 cable Maximum distance: 100m				
UGA inputs	UGA inputs 1 - 4 : triggerable on a voltage (22V ~ 60V)				
Dry contact inputs	Dry contact inputs from (1 - 4) : triggerable on dry contact NO/NF				
Dry contact outputs	Dry contact outputs from (1 - 4) : Relay output				
Speaker line outputs	4-pin connector, (1ch) for channels A+B				
Backup amplifier input	1 input per channel, for amplifier with equal power				
Protection	Current protection, temperature protection, DC voltage output protection, overload				
MTTF availability	Average failure time greater than 100,000 hours				
MTTR availability	Average repair time less than 20 minutes				
AES/EAE emergency power input	24VDC				
FAULT-IN input	Supervised fault input for remote fault reporting (e.g. AES/EAE)				
Screen	1.3" OLED screen				
Operating temperature	-10°C ~ +40°C / Humidity: 5 - 95%				
Weight	8,59kg	9,1kg	10,1kg	8,56kg	9,7kg
Dimensions (WxHxD)	482 x 88 x 450mm				
Accessories	AC power cord, Euroblock connectors, Rack mount screws, User manual				
Protocol and encryption	TCP/IP, Http, Https, SNMP V2c, IPv4, TLS1.2, SHA256, SSL, AES-256, Elliptic curve cryptography				



Rear panel

PN-106 / PN-112 / PN-236 / PN-260
60 / 120 / 360 / 600W amplifiers over IP network



- The PN Series amplifiers are amps-preamps that allow audio streams to be received remotely over the IP network.
- They can be deployed in various locations without constraint of cables and are controlled remotely via the NCS system
- They are ideal for schools, industrial buildings, chain of stores... (management of priorities of audio inputs, volume control, audio file management...)

Model	PN-106	PN-112	PN-236	PN-260
Nominal power RMS	60W	120W	360W	600W
Bandwidth (1W, 0±3dB)	80 to 15,000Hz			
THD @ 1kHz	< 1%			
S/B (A-WTD) @1kHz	70dB			
	55dB			
Input sensitivity / Impedance	Input 1	MIC	-60dBV / 2kΩ (Balanced)	
	Input 2	LINE	0dBV / 24kΩ (Unbalanced)	
		MIC	-60dBV / 2kΩ (Balanced)	
	Network	Audio	-2.2dBV	
Output Impedance	100V / 166Ω	100V / 84Ω	100V / 27.7Ω	100V / 16.6Ω
	70V / 82Ω	70V / 41Ω	70V / 13.6Ω	70V / 8.1Ω
	22V / 8Ω	22V / 4Ω	38V / 4Ω	49V / 4Ω
Network communication	100/1000 base-T (RJ-45)			
Operating Temperature	-10°C ~ +40°C			
Power source	120-240V AC, 50/60Hz		220-240V AC, 50/60Hz	120-240V AC, 50/60Hz
Consumption	55W		110W	150W
Dimensions (WxHxD)	420 x 44 x 320mm		420 x 88 x 320mm	
Weight	4.49kg		5.02kg	5.23kg
Accessorie (optional)	Rack mount brackets BKT-DSA100D-F		Rack mount brackets BKT-A120	



AVIO ANALOG IN 2X0 : converter of 2 line-level analog audio signals entering a Dante™ network

AVIO ANALOG 0 0X2 : converter allowing the output of 2 line-level analog audio signals from a Dante™ network



AVIO ANALOG IN 2X0



AVIO ANALOG 0 0X2

Network all your audio gear easily and cost-effectively with Dante AVIO™

Dante AVIO Adapters let you use all your legacy audio gear with any Dante-connected system, delivering the interoperability, performance and scalability that only networking can bring. Cost effective, compact and built for the road, Dante AVIO adapters bring the modern network connectivity that every audio pro needs in their toolbox.

Plug & Play

Each Dante AVIO adapter is a complete, high-performance Dante device, delivering all the automation and ease of use that have made Dante the most popular audio networking solution worldwide. Dante AVIO adapters are automatically discovered and ready to use when connected, and no separate power supplies are required – just use a common PoE (Power over Ethernet) switch and Dante AVIO adapters are ready to go.

On the road again

We've made Dante AVIO adapters road-ready and tour-tough. Sonically-welded ABS enclosures and quality

hardware are used throughout, while cable assemblies are stress-tested to ensure reliable operation under grueling conditions. Toss them in your toolbox, show after show.

True Dante™

Dante AVIO™ converters are true Dante interfaces, with all the features you expect from Dante® audio networking. Each offers pristine audio reproduction, ultra-low latency, and precise synchronization across the entire network. All Dante devices discover each other automatically and the entire system is managed by the easy-to-use "Dante Controller" software on any connected PC or Mac. More importantly, every Dante device can instantly connect to every other Dante device. All Dante AVIO™ converters are fully compatible with Dante Domain Manager (DDM) for security and IT workflow management. AES67 is supported for connection to non-Dante networks.

Model	AVIO ANALOG IN 2X0	AVIO ANALOG 0 0X2
Network Transport	Dante Audio over IP AES67 RTP	
Sample Rates	44.1, 48, 96kHz	
Bit Depth	24	
Input signal	+24dBu / +4dBu / 0dBu 0dBV / -10dBV	
Output signal	+18dBu / +4dBu / 0dBu 0dBV / -10dBV	
Impedance	20kΩ balanced - 10kΩ Unbalanced	150Ω balanced - 75Ω Unbalanced
Bandwidth	20 to 20,000Hz (±0.5dB)	
Dynamic range	> 100dB	
S/N ratio	> 100dB	
THD	< 0.01% @ +4dBu	
Connector	RJ45 - 2 XLR-F	RJ45 - 2 XLR-M
Power source	Class 1 802.3af PoE	

DASR-288**8-channel digital audio transport system over IP**

- It connects to your network with a single Ethernet cable.
- It is a Dante™ Break Out/Encoder interface in a 2RU form factor designed for all types of commercial AV installations. It offers eight channels of line-level analogue in and 8 line-level analogue outputs. Precision 24-bit A-D and D-A converters are used for superb audio performance with a 119dB dynamic range at sample rates up to 192kHz.
- This product is used as the audio matrix, each having eight inputs, where you can send uncompressed audio with low latency using standard TCP/IP Ethernet network. It's remotely controlled via the network and can be placed anywhere in a facility. Unique to the DASR-288 is its Data tunneling. No other manufacturer offers this feature, which allows you to transport with the Digital audio, 8 contact closures in and 8 contact closures out together combined with either RS-232C serial data.
- Each of the 8 balanced analog inputs and 8 outputs may be assigned to any Dante flow in the system, either by means of the Audinate's Dante Controller Windows or OSX application or Inter-M's own S-Connect Windows Software. The S-Connect allows for system configuration as well as easy channel switching. The S-Connect Software is designed to operate by simple touch screen.
- Dual redundant Gigabit Dante™ Network connections are available. Both primary and secondary connections support full Gigabyte ports for full redundancy.
- Signal Monitoring is available for all 8 inputs and 8 outputs with a front panel mounded dual LEDs, indicating signal presence and clipping. Network status LEDs also monitor network connectivity and transition speed.

Model	DASR-288
Max. INPUT Level	+20dBu (8 balanced audio channels at Line levels)
Max. OUTPUT Level	+20dBu (8 balanced audio channels at Line levels)
Bandwidth ±3dB	20Hz - 20kHz
THD	< 0.1%
Sampling	48kHz - 24Bit
Communication	Dry Contact, RS-232C
Dry Contact	8 Input, 8 Output
Baudrate	9,600bps ~ 115,200bps
Ethernet(LAN)	10/100/1000 Base-Tx, (RJ-45)
Operating Temperature	0°C-40°C
Power Source	AC 120V - 240V, 50/60Hz or DC 24V
Power Consumption	25W
Dimensions(W×H×D)	482 × 88 × 280mm · 2U
Weight	4kg

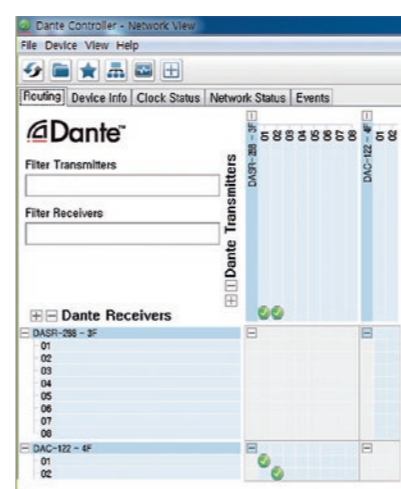

Rear panel

AFD-6218**8 amps control unit**

- Control unit lets you switch to a backup amp.
- Control up to 8 amps simultaneously.
- An adjustable-interval test controls connected amps automatically.
- Front-panel LEDs let you monitor amp status directly.
- Failures can also be viewed in the system software.

Model	AFD-6218
Amp inputs	8 + 1 safety amp
Amp outputs	8 + 1 safety amp
Audio inputs	8
Operating temperature	-10°C ~ 40°C
Power source	24VDC, 170mA
Dimensions (WxHxD)	482 x 88 x 280mm · 2U
Weight	4kg



Rear panel

Speaker lines control

PM-9208

8 zones speaker lines control unit



- It provides audible and visual monitoring of up to 8 single-channel amplifiers or speaker lines.
- 8 x 8-segment LED displays monitor up to 8 amplifier outputs or speaker lines, with 5-step attenuation to match different amplifier levels.
- A built-in speaker allows monitoring of the selected channel and features 4-step attenuation. The speaker is passive (no internal amplifier) and the LED display requires 24VDC (power supply not included).

- 8-Channel Monitor Panel
- 10 Segments LED Meter for Each Channel
- Built-In Monitor Speaker
- Channel Selector Switches
- LED Indication on Each Switch
- Monitors 8 70/100V Lines
- 24VDC Operation Only
- Rack Mount (2U)
- Power Supply Not Included

Model	PM-9208
Inputs	8 x 100V / 70V
LED display	8 outputs (simultaneous)
Attenuator	5 positions
Output power	Max 1.5W
Frequency response	32 to 16,000
Operating temperature	-10°C ~ 40°C
Power source	24VDC
Dimensions (WxHxD)	482 x 88 x 280mm · 2U
Weight	3.8kg



Rear panel

ALIM 24VDC 1.25A: 220V/24VDC - 1.25A - 30W power supply

- A constant voltage switching power supply which connects directly to a mains using a 3-point IEC cable and provides constant 24V voltage for a maximum power of 30W.



Speaker lines control

SC-6224

Loudspeaker lines control



- Test up to 24 loudspeaker lines automatically at a configurable, regular interval.
- Line failures (open circuit, short circuit, overloads, etc.) are signaled by front-panel LEDs and an audible signal.

Model	SC-6224
Line impedance test	20Ω - 3kΩ
Test duration / channel	< 100ms
Test interval	5-200min
Channels	24
Operating temperature	-10°C ~ 40°C
Power source	24VDC, 200mA
Dimensions (WxHxD)	482 x 88 x 280mm · 2U
Weight	4.4kg

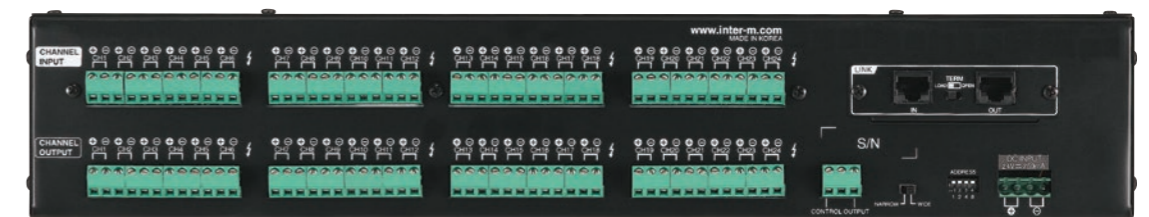

Rear panel

ALIM 24VDC 1.25A: 220V/24VDC - 1.25A - 30W power supply

- A constant voltage switching power supply which connects directly to a mains using a 3-point IEC cable and provides constant 24V voltage for a maximum power of 30W.



Remote PA monitor

PM-N108

Remote PA monitor



- PM-N108 is a system audio monitoring equipment via network when long distance network PA or mass PA system is configured..
- ETHERNET Gigabit 100/1000Mbps.
- Receiving audio source by network..
- Monitoring of 8 line channel audio inputs.
- Monitoring of 8 100V amplifier channels.
- Boundless expansion by network.
- Web-based setting.
- The equipment can check power amplifier output and status of line level audio via PC or mobile devices..
- Also, status of total system can be monitored in real time.

Model	PM-N108	
AUDIO	Audio Input Channel	8CH
	Audio Input Level	0dBV (1Vrms)
	Frequency Response (0dBV)	20Hz ~ 20kHz
	THD+N Ratio (20Hz HPF, 20kHz LPF, 0dBV, 1kHz)	Less than 0.1%
	S/N (20Hz HPF, 20kHz LPF, 0dBV, 1kHz)	More than 80dB
	100V Amplifier Input Channel	8CH
	Amplifier Input Level	40dBV (100Vrms)
	THD+N Ratio (20Hz HPF, 20kHz LPF, 40dBV, 1kHz)	Less than 1%
Network Communication		100/1000 Base-T
Operating Temperature		0°C ~ 40°C
Power Source		24 V DC, 300mA
Dimensions (WxHxD)		482 x 44 x 280mm
Weight		3.04kg



Rear panel

Ethernet Switch

SWITCH GIGABIT 24P

Switch - 24 ports - Gigabit (1GbE) - Unmanaged - Rack mountable



- Economical and high performance GbE layer 2 switching.
- It gives to small businesses 10 times the performance of Fast Ethernet with the simplicity of unmanaged plug and play.
- Unmanaged switches are a cost-effective solution for small businesses and are suitable for sites that only need basic Layer 2 switching in a flat, single-level network.
- The half-duplex / full-duplex auto-negotiation feature on each port doubles the throughput of each port.
- This model has silent fanless operation, automatic functions for standalone use and low power consumption.

Main Features:

- Switch 24 ports 1GbE with two links 1 / 10GbE SFP +
- Packet buffer size: 1.5 MB dynamically allocated
- Throughput: up to 38.7 Mpps
- Switching capacity: 52 Gbit/s

Model	SWITCH GIGABIT 24P
Type of device	Switch - 24 ports - unmanaged
Type	Desktop computer, Rack mountable - 1U
Subtype	Gigabit Ethernet
Ports	24 x 10/100/1000 + 2 x Fast Ethernet/Gigabit SFP
Performance	Switching capacity: 52Gbps / Flow: 38.7Mpps
The MAC address table size	8,192 entries
Jumbo frame support	9,216 bytes
Features	Control flow, auto-negotiation, auto-uplink (auto MDI/MDI-X), half-duplex mode, full-duplex, quality of service (QoS), fanless, buffer packets 512 KB, support DiffServ Code Point (DSCP)
Compliance with standards	IEEE 802.3, IEEE 802.3u, IEEE 802.3i, IEEE 802.3ab, IEEE 802.1p, IEEE 802.3x, IEEE 802.3az
Flash memory	1 Mo
Interfaces	24x RJ45 in 1000Base-T and 2xSFP Gigabit LAN
Power device	Internal power supply
Tension require	120/230VAC (50/60Hz)
Reliability MTBF	126.1 years
Compliance with standards	CISPR 24, EN55022, IEC 61000-3-2, IEC 61000-3-3, IEC 61000-4-11, IEC 61000-4-2, IEC 61000-4-3, IEC 61000-4-4, IEC 61000-4-5, IEC 61000-4-6, IEC 61000-4-8, EN55024, CISPR 22, CSA 22.2 No. 60950, UL 60950-1, IEC 60950-1, EN 60950-1, FCC Part 15 B Class A
Temperature	Operating : 0 to 40°C • Storage : -40 to 70°C
Humidity	Operating: 10% to 90% without condensing • Storage : 5% to 90% without condensing
Dimensions (WxHxD)	440 x 44 x 173mm
Weight	2.2kg

ZY-IP-SWFOM06RJ**Monomode managed Ethernet switch with 6 RJ-45 ports and 2 optic fiber ports**

NEW

- 8-port switch
- Copper and Optic Fiber ports
- DIN-rail mounting
- Redundant dual power supply
- IP 30



- The ZY-IP-SWFOM06RJ is an Ethernet switch made of 6 Copper ports (10/100BaseT(X)) and 2 Optic Fiber ports (100BaseFX (SC)).
- It supports a variety of management functions, such as Turbo Ring, port-based VLAN, QoS, bandwidth management and warning by email or relay
- The ready-to-use Turbo Ring can be set up easily using the web-based management interface, or with the DIP switches.
- Its design for industrial environments makes it adaptable to any application requiring high availability.
- The ZY-IP-SWFOM06RJ can operate from 0 to 60°C.

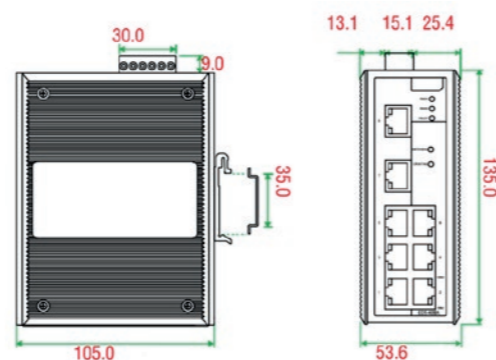

Model	ZY-IP-SWFOM06RJ
Interfaces	RJ45 x6 SC x2
Fiber transmission	0 dBm / -5 dBm
Fiber reception	- 34 dBm
Fiber length	40 km
Fiber saturation	- 3 dBm
Power supply	24 VDC (redundant dual inputs)
Dimensions	135 x 105 x 53.6 mm
Material	Metal
Weight	0.650 kg
IP Rating	IP 30
Installation	DIN-rail mounting

ZY-IP-SWFOMU6RJ**Multimode managed Ethernet switch with 6 RJ-45 ports and 2 optic fiber ports**

NEW

- 8-port switch
- Copper and Optic Fiber ports
- DIN-rail mounting
- Redundant dual power supply
- IP 30



- The ZY-IP-SWFOMU6RJ is an Ethernet switch made of 6 Copper ports (10/100BaseT(X)) and 2 Optic Fiber ports (100BaseFX (SC)).
- It supports a variety of management functions, such as Turbo Ring, port-based VLAN, QoS, bandwidth management and warning by email or relay
- The ready-to-use Turbo Ring can be set up easily using the web-based management interface, or with the DIP switches.
- Its design for industrial environments makes it adaptable to any application requiring high availability.
- The ZY-IP-SWFOMU6RJ can operate from -10 to 60°C.

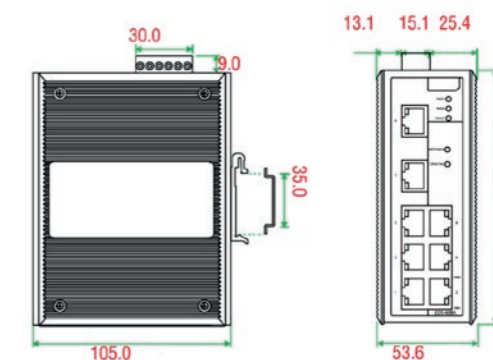

Model	ZY-IP-SWFOMU6RJ
Interfaces	RJ45 x6 SC x2
Fiber transmission	-10 dBm / -20 dBm
Fiber reception	- 32 dBm
Fiber length	4 to 5 km
Power supply	24 VDC (redundant dual inputs)
Dimensions	135 x 105 x 53.6 mm
Material	Metal
Weight	0.650 kg
IP Rating	IP 30
Installation	DIN-rail mounting

PoE Switch

SWITCH POE 5P

5-Port Gigabit Desktop Switch with 4-Port PoE



SWITCH POE 5P is a 5 10/100/1000Mbps ports unmanaged switch that requires no configuration and provides 4 PoE (Power over Ethernet) ports. It can automatically detect and supply power with all IEEE 802.3af compliant Powered Devices (PDs). In this situation, the electrical power is transmitted along with data in one single cable allowing you to expand your network to where there are no power lines or outlets, where you wish to fix devices such as APs, IP Cameras or IP Phones, etc.

Model	SWITCH POE 5P
Standards	IEEE 802.3, IEEE 802.3u, IEEE 802.3x, IEEE 802.1p, IEEE 802.3af
Interface	<ul style="list-style-type: none"> • 5 x 10/100/1000Mbps RJ45 Ports with 4 x PoE Ports (Port 1 to Port 4) • AUTO Negotiation/AUTO MDI/MDIX
Network Media	<ul style="list-style-type: none"> • 10BASE-T: UTP category 3, 4, 5 cable (maximum 100m) • EIA/TIA-568 100Ω STP (maximum 100m) • 100BASE-TX: UTP category 5, 5e cable (maximum 100m) • EIA/TIA-568 100Ω STP (maximum 100m) • 1000BASE-T: UTP category 5, 5e, 6 or above cable (maximum 100m) • EIA/TIA-568 100Ω STP (maximum 100m)
Power Consumption	<ul style="list-style-type: none"> • 4.26 watts (max. no PD connected) • 63.31 watts (max. with 56w PD connected)
PoE Ports (RJ45)	<ul style="list-style-type: none"> • Standard : 802.3 af compliant • PoE Ports : Port1- Port4 • Power Supply : 56W
Transmission Method	Store-And-Forward
Switching Capacity	10Gbps
Mac Address Table	2K
Fan Quantity	Fanless
External Power Supply	External Power Adapter (Output: 48VDC / 1.25A)
LED	Power, Link/Act, PoE Status, PoE Max
Dimensions (W x D x H)	3.9 x 3.9 x 1.0 in. (99.8 x 98 x 25 mm)
Certification	FCC, CE, RoHS
Package Contents	SWITCH POE 5P, Power Adapter, User Guide
Environment	<ul style="list-style-type: none"> • Operating Temperature : 0°C~40°C (32°F~104°F) • Storage Temperature : -40°C~70°C (-40°F~158°F) • Operating Humidity : 10% ~ 90%RH, non-condensing • Storage Humidity : 5%~90%RH, non-condensing

PoE Switch

SWCH POE 8P+2SFP D

8 ports PoE Gigabit Switch



SWCH POE 8P+2SFP D is a managed AI PoE switch specially designed for security transmission. It supports PoE power supply requirements and Gigabit uplink ports, supports complete security protection mechanisms, complete ACL/QoS policies and rich VLAN functions.

Model	SWCH POE 8P+2SFP D
Network Interface	<ul style="list-style-type: none"> • 8 10/100/1000Mbps RJ45 ports • 2 Gigabit SFP fiber ports
Protocol standard	IEEE802.3, IEEE802.3i, IEEE802.3u, IEEE802.3ab, IEEE802.3z, IEEE802.3ad, IEEE802.3x, IEEE802.3af/at, IEEE802.1p, IEEE802.1q, IEEE802.1w, IEEE802.1d, IEEE802.1s
Performance	
Backplane bandwidth	20Gbps (non-blocking)
Packet forwarding rate	14.9Mpps
MAC address table	8K
Port cache	4.1Mb
Forwarding mode	Store and forward
LED indicator	<ul style="list-style-type: none"> • 10 Link/Act indicator • 1 Power indicator • 8 PoE indicator • 1 SYS indicator
PoE pin	1/2 (+), 3/6 (-)
Power support	<ul style="list-style-type: none"> • Single port maximum output power : 30W • The maximum power of the whole machine : 96W
Physical	
Dimensions (LxWxH)	225mm×120mm×35mm
Working temperature	0°C~40°C
Storage temperature	-40~70°C
Working humidity	10%~ 90% RH without condensation
Storage humidity	5%~90% RH without condensation
Safety regulations	CE/ROHS/FCC

SWCH 24P POE N-MAN

24 ports Gigabit PoE Switch



High PoE Power Budget

- 370W PoE power budget
- Compliant with IEEE 802.3af/at
- PoE usage indicator LEDs

Versatile Connectivity

- 24 10/100/1000 Mbps PoE ports
- 2 Gigabit combo uplink ports

Reliability

- IEEE 802.3x flow control
- Store-and-forward switching scheme

Easy Setup

- Plug-and-Play installation
- Auto MDI/MDI-X crossover for all ports

Green Features

- IEEE 802.3az Energy Efficient Ethernet
- RoHS-compliant

Model	SWCH 24P POE N-MAN
Number of Ports	24x ports 10/100/1000Mbps • 2x ports combo10/100/1000BASE-T/SFP
Standards	Ethernet 10BASE-T IEEE 802.3 / Fast Ethernet IEEE 802.3u 100BASE-TX Gigabit Ethernet IEEE 802.3ab 1000BASE-T / IEEE 802.3z / IEEE 802.3x Flow Control IEEE 802.3az Energy Efficient Ethernet (EEE)
Switching Capacity	52 Gbps switching fabric
64 Byte Max. Forwarding Rate	38.69Mpps
Media Interface Exchange	Auto MDI/MDI-X
Transmission Method	Store-and-forward
MAC Address Table	8K (8192) entries per device
Packet Buffer Memory	512 KB per device
PoE Standards	IEEE 802.3at • IEEE 802.3af
PoE Ports	Ports 1 to 24
PoE Budget	370W • Up to 30W per port
LED Indicators	Per port: Activity / Link and Speed • Per PoE port: Power Fail / Power OK • Per Unit: Power / PoE Power Budget
Fan	2 x Smart fans
Dimensions (WxDxH)	440 x 250.4 x 44mm
Weight	3.1kg
Power Input	AC Input: 100 to 240VAC, 50/60Hz
Power Consumption	Maximum: 444.1W (PoE on) • 82.1W (PoE off) • 240V: 18.25W
Temperature	Operating: 0 to 50 C • Storage: -40 to 70 C
Humidity	Operating: 10% to 90% RH, non-condensing • Storage: 5% to 90% RH, non-condensing
MTBF	205,975 hours
Heat Dissipation	1,515 BTU/h
IME	FCC Class A • CE • CCC • RoHS • VCCI • BSMI • RCM
Safety	UL/CSA 60950-1 • EN 60950-1 • IEC 60950-1

PO-6106

1 input/6 outputs Audio Distributor



- An audio distributor with 1 input and 6 adjustable-level outputs.

- Lets you distribute a 0-dB analog audio signal across up to 6 outputs with no level loss.

Model	PO-6106
Audio input	1x XLR female balanced 0dB
Audio outputs	6x XLR male balanced 0dB
Bandwidth (± 3 dB)	20 to 20,000Hz
Input sensitivity	1V ± 0.2 V
Max output level	3V ± 0.5 V
S/N Ratio	> 70dB
THD	< 0.1%
Power source	AC 220V or DC 24V
Dimensions (WxHxD)	482 x 44 x 280mm • 1U
Weight	4kg



Rear panel

PB-6207**24VDC battery charger**

• The PB-6207 is a unit for recharging the battery to insure that the battery's maximum charge capacity is achieved.

• **BATTERY AUTO RECHARGING**

It charges with maximum 3A, when it close to full charging (26.4V) the electric current will be reduced up to 10mA-20mA for maintaining a full charging.

• **VOLTAGE/CURRENT DISPLAY**

Front LCD displays status of power distribution (Voltmeter/ Amperemeter).

• **PC MONITORING**

The charging voltage and current can be monitored by window program of 6800 System.

Model	PB-6207
Full charge voltage	26.4V
Starting current	3A Max.
Operating temperature	-10°C ~ 40°C
Power source	230VAC · 50/60Hz
Dimensions (WxHxD)	482 x 88 x 280mm · 2U
Weight	6kg

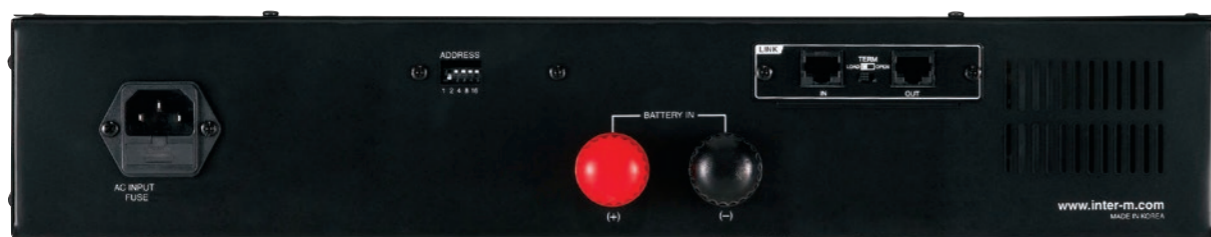

Rear panel

BACKUP BATTERIES

Stationary sealed lead batteries, gas recombination, valve regulated, maintenance free :

- 12V - 17Ah : **BAT12V17AH**
- 12V - 25Ah : **BAT12V25AH**
- 12V - 38Ah : **BAT12V38AH**
- 12V - 65Ah : **BAT12V65AH**
- 12V - 78Ah : **BAT12V78AH**
- 12V - 100Ah : **BAT12V100AH**
- 12V - 150Ah : **BAT12V150AH**
- 12V - 210Ah : **BAT12V210AH**

**PC-2104****Intercom Master Station - 4 directions**

- Stand-alone master stations - 4 directions
- Integrated microphone
- High efficiency- class D
- High acoustic quality
- 4 directions + All-call
- Adjustable volumes
- Can be laid on a table or fixed vertically on a wall

- The PC-2104 is a master station which can be connected to 4 remote units.
- This high efficiency intercom unit is equipped with a class D amplifier and an integrated loudspeaker offering high sound reproduction with good intelligibility.

- Metal casing covered with epoxy painting guarantees shock resistance.
- The PC-2104 can be laid on a table or fixed vertically on a wall and can be used with all our remote stations (PS-2101, PS-2601, PS-630 et PS-901).

Model	PC-2104
Master station power	1,2 W
Remote station impedance	16 Ω / 50 Ω
Qty of remote stations	4
Call to remote station	Vocal or sound
Call from remote station	Sound and luminous
Stored call	Yes
Speech / listening function	Manual
All-call	Yes
Electric strike control	Yes
Connection cable	Shielded pair
Dimensions	260 x 160 x 51 mm
Color	Black and grey
Material	Metal
Weight	1.55 kg

PC-2108**Intercom Master Station - 8 directions**

- Stand-alone master stations – 8 directions
- Integrated microphone
- High efficiency– class D
- High acoustic quality
- 8 directions + All-call
- Adjustable volumes
- Can be laid on a table or fixed vertically on a wall



- The PC-2108 is a master station which can be connected to 8 remote units.
- This high efficiency intercom unit is equipped with a class D amplifier and an integrated loudspeaker offering high sound reproduction with good intelligibility.

- Metal casing covered with epoxy painting guarantees shock resistance.
- The PC-2108 can be laid on a table or fixed vertically on a wall and can be used with all our remote stations (PS-2101, PS-2601, PS-630 et PS-901).

Model	PC-2108
Master station power	1,2 W
Remote station impedance	16 Ω / 50 Ω
Qty of remote stations	8
Call to remote station	Vocal or sound
Call from remote station	Sound and luminous
Stored call	Yes
Speech / listening function	Manual
All-call	Yes
Electric strike control	Yes
Connection cable	Shielded pair
Dimensions	260 x 160 x 51 mm
Color	Black and grey
Material	Metal
Weight	1,55 kg

PC-2112**Intercom Master Station - 12 directions**

- Stand-alone master stations – 12 directions
- Integrated microphone
- High efficiency– class D
- High acoustic quality
- 12 directions + All-call
- Adjustable volumes
- Can be laid on a table or fixed vertically on a wall



- The PC-2112 is a master station which can be connected to 12 remote units.
- This high efficiency intercom unit is equipped with a class D amplifier and an integrated loudspeaker offering high sound reproduction with good intelligibility.

- Metal casing covered with epoxy painting guarantees shock resistance.
- The PC-2112 can be laid on a table or fixed vertically on a wall and can be used with all our remote stations (PS-2101, PS-2601, PS-630 et PS-901).

Model	PC-2112
Master station power	1,2 W
Remote station impedance	16 Ω / 50 Ω
Qty of remote stations	12
Call to remote station	Vocal or sound
Call from remote station	Sound and luminous
Stored call	Yes
Speech / listening function	Manual
All-call	Yes
Electric strike control	Yes
Connection cable	Shielded pair
Dimensions	260 x 160 x 51 mm
Color	Black and grey
Material	Metal
Weight	1,55 kg

PC-3112**Stand-alone intercom master station**

- Stand-alone power master station - 12 directions
- High efficiency- class D
- High acoustic quality
- Locked microphone plug
- 12 directions + All-call
- Integrated microphone and palm microphone
- Can be laid on a table or fixed vertically on a wall
- Flush mounted



- The PC-3112 is a high power intercom unit.
- It is intended for industrial applications (workshops, warehouses, car parks...) and noisy areas for which the provided hand-held microphone is perfectly adapted.
- This high efficiency intercom unit is equipped with a class D amplifier and an integrated loudspeaker

offering high sound reproduction with good intelligibility.

- The PC-3112 can be used with all our remote stations (PS-2101, PS-2601, PS-630 et PS-901).

Model	PC-3112
Master station power	15 W / 16 Ω
Remote station impedance	5 W / 50 Ω
Qty of remote stations	12
Call to remote station	Vocal or sound
Call from remote station	Sound and luminous
Stored call	Yes
Speech / listening function	Manual
All-call	Yes
Power supply	18 to 26 V (power supply 24V / 3A not included)
Connection cable	Shielded pair
Dimensions	332 x 172 x 43 mm
Color	Black and grey
Material	Metal
Weight	2,9 kg

PS-2101**Intercom substation**

- Secondary stations suited to all environmental constraints
- High acoustic quality
- Secret function
- Integrated microphone
- Refined design
- Wall or table mounting



- The PS-2101 is an intercommunication remote station for tertiary and industrial applications (gas stations, car parks, restaurants,...).
- This high efficiency intercom offers high sound reproduction with good intelligibility.
- Metal casing covered with epoxy painting guarantees

impact resistance.

- The PS-2101 can be laid on a table or fixed vertically on a wall.
- It is compatible with our master stations (PC-2104, PC-2108, PC-2112 et PC-3112).

Model	PS-2101
Line impedance	16 Ω
Secret function	Yes
Connection cable	Shielded pair
Dimensions	155 x 82,4 x 41,2 mm
Colour	Black and grey
Material	Metal
Weight	0,9 kg

PS-2601 Intercom substation



- Secondary stations
- Vandal call button
- Waterproof
- Noisy areas
- Integrated microphone
- Vandal-resistant construction
- Indoor and outdoor
- Impedance 50 Ohms
- Power 1W



- The PS-2601 is an intercommunication remote station.
- It can be used either as standalone station or with call/answer function thanks to its vandal call button and integrated loudspeaker.
- Its high efficiency ensures an excellent sound distribution, especially in noisy areas.
- It is weather and shock-resistant and can therefore be used anywhere outdoors.
- Its fixing device allows flush-mounting or wall-mounting.

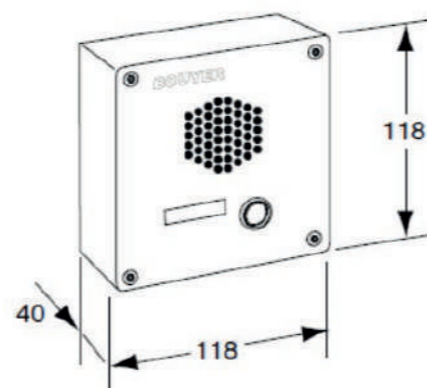

Model	PS-2601
Acceptable power	1W
Impedance	50 Ω
Loudspeaker	Mylar membrane
Dimensions	118 x 118 x 40 mm
Color	Ivory RAL 1013
Material	Aluminium / Metal
Weight	0,350 kg

PS-630 Intercom substations for noisy environments



- Secondary stations suited to all environmental constraints
- Noisy areas
- Horn speaker
- Swivel bracket
- IP 54 protection index



- The PS-630 is a horn-loudspeaker-type intercom remote station.
- Its high performance ensures perfect speech reproduction over long distances and excellent sound distribution in noisy areas.
- Made out of ABS, it is weather and shock resistant and can therefore be used anywhere outside.
- Its fixing device makes easier its orientation and ensures quick and easy installation.

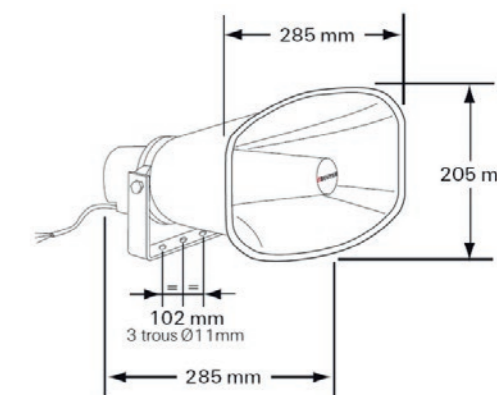

Model	PS-630
Master station power	15W
SPL	104/dBA/1W/1m
SPL max	116/dBA/10W/1m
Bandwidth	400Hz - 5kHz
Impedance	50-60 Ω
Directivity-6dB	Vertical : 50° Horizontal : 70°
Connection cable	1 screened pair
Dimensions	285 x 285 x 205 mm
Color	White RAL 9010
Material	Horn : ABS. Brackets : Aluminium.
Weight	1,8 kg
Particularity	Swivel bracket. For use with PS2601.

PS-901**Intercom substation for use in noisy or isolated areas**

- Secondary stations suited to all environmental constraints
- Works with PZ-10 headset



- The PS-901 is an intercommunication remote station designed for use in noisy environments and/or environments which are subject to humidity, dust or other adverse physical conditions.
- It can be used with a headset with microphone (PZ 10) for applications in extremely noisy environments.
- The casing is in stove-enamelled galvanized sheet metal.
- The front panel contains the "Call" push-button and a 6.35 mm jack for a headset of the PZ 10 type, both protected by a transparent sealing flap.

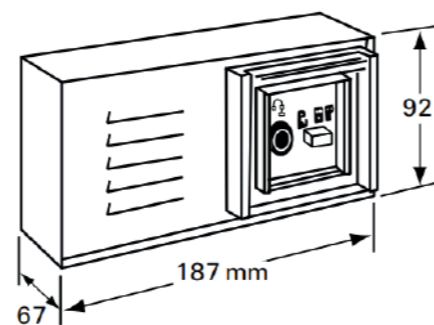

Model	PS-901
Power	0,5 W
Dimensions	187 x 67 x 92 mm
Color	Grey and black
Material	Metal cabinet
Weight	0,7 kg

PZ-10**Headset microphone for PS-901 intercom substation**

- Microphone headset for noisy surroundings
- Dynamic microphone
- Sound-insulated closed headphones
- 6.35 mm jack plug
- Works with PS-901 intercom substation



- The PZ-10 is a headset with microphone for the PS-901 intercom substation.

- It enables discreet, direct, noise-free conversation.

Model	PZ-10	
Headset	Acoustic insulation	> 10 dBA
	Frequency range	100 - 10 000 Hz
	Sensibility	88 dB
	Power handling capability	200 mW
	T.H.D.	< 3%
Microphone	Type	Dynamic
	Polar Pattern	Hypercardioid
	Frequency range	100 - 10 000 Hz
	Sensitivity	0,8 mW/Pa
Accessory	1,5m cable and jack 6,35 plug	
Weight	0,275 Kg	

IZ-2020**20-way intercom central unit**

- 20-way intercom central unit
- Cascadable up to 80 directions
- Music source management
- Integrated line monitoring
- Easy installation through bus
- Music broadcasting via AUX input



- The IZ-2020 is a 20-way intercom central unit with mains power supply.
- It is possible to cascade 4 IZ-2020 to get an installation with 80 remote stations.
- The IZ-2020 is provided with monitoring system for

- remote lines and music broadcasting zone control.
- Works with intercom substation from 16Ω to 50Ω.

Model	IZ-2020
Audio signal	2,2 V
Speech line output	16 Ω
Bus audio signal	- 10 dBu
Dimensions	378 x 206 x 75 mm
Color	Anthracite grey
Material	Casing : metal
Weight	3,4 kg

CONF-RJ45-SWITCH
2 ports RJ45 splitter

- RJ45 splitter
- Compact box
- 2 RJ45 ports for star wiring architecture



- This RJ45 splitter is used to add a star wiring configuration to a conference system loop or bus, as in the example below :

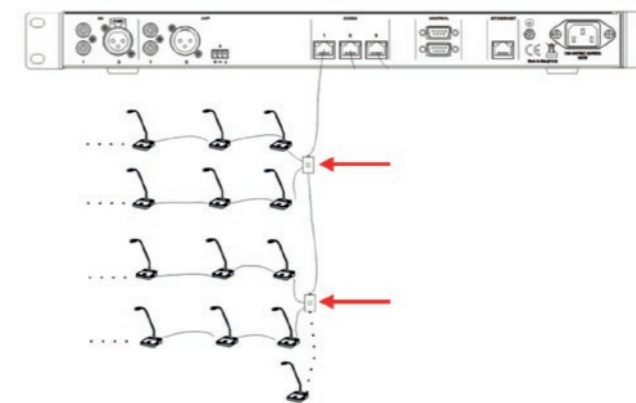

Model	CONF-RJ45-SWITCH
Ports	4 ports RJ45 2 ports for bus wiring 2 ports for star wiring
Power	48 VDC (supplied by main unit)
Consumption	0,9 W
Dimensions	80 x 50 x 23 mm
Color	Black
Material	Metal
Weight	100g

IG-1900 Counted intercom

- Ideal counters & ticket offices
- Console with embedded mic. & loudspeaker
- Robust all-in-one client-side module
- Quick and easy installation



- The counter intercom IG-1900 is ideal for closed counters or counters with glass/plexiglass protection.
- It facilitates the transmission of messages between interlocutors and guarantees intelligible communication in total safety.
- It also has intelligent audio functions such as active noise reduction and automatic sound level adjustment to ensure optimal exchange quality.

- It consists of a microphone console with integrated loudspeaker on the counter side (receptionist) and an all-in-one module with microphone and integrated loudspeaker on the customer side.
- An AUX output also allows you to connect a magnetic induction loop, for example.

Detailed dimensions

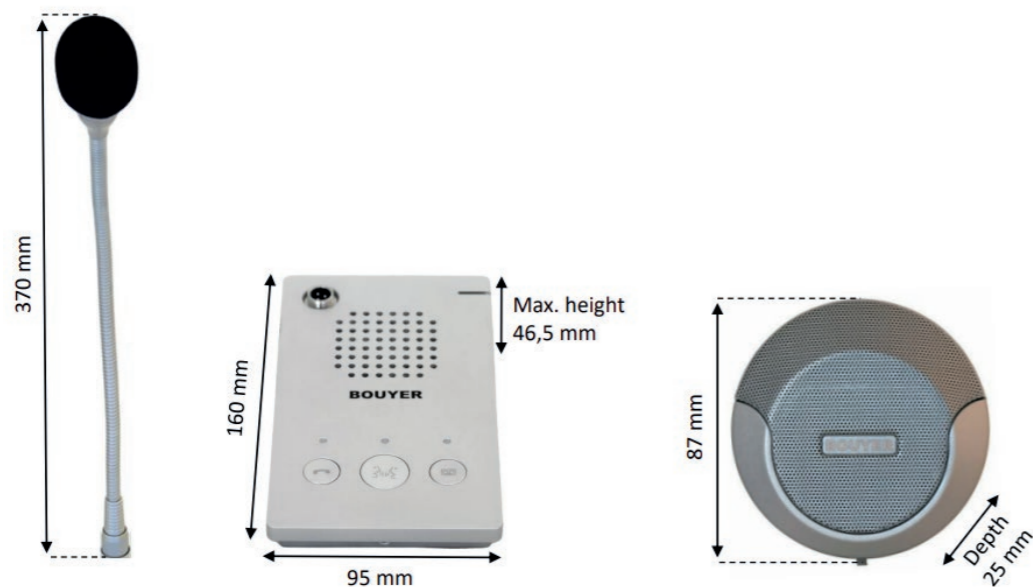

Model	IG-1900
MAIN CONSOLE	
Microphone type	Condensateur - Unidirectionnel
Sensitivity	- 46 dB
Frequency response	20 Hz - 16 kHz
Embedded speaker	3 W (100Hz - 18kHz)
Power supply	DC 12V 1.5A / Conso. ≤ 5W (Mains charger EU type C plug supplied)
Temperature range	-10° / + 50°C
Humidity range	≤ 90% RH
Color	Silver
Material	Steel
Dimensions (l x p x h)	95 x 160 x 46.5mm
Weight	440 g
SECONDARY UNIT CLIENT'S MODULE	
Microphone type	Electret - Unidirectional
Sensitivity	- 46 dB
Frequency response	20 Hz - 16 kHz
Embedded speaker	3W (92 dB @ 1W / 1m) 100 Hz - 18kHz
Power supply	Powered by main console
Temperature range	-10° / + 50°C
Humidity range	≤ 90% RH
Color	Silver
Material	Aluminium
Dimensions (l x p x h)	87 x 25 x 87mm
Weight	200 g



BOUCLE COMPTOIR (NOT INCLUDED)



This small self-adhesive magnetic loop is designed for sending induction loop signals over limited areas, such as individual consultation stations or receptions. Mounting, usually below a table surface, is achieved using self-adhesive clamps for a 35 x 35 cm surface.

Induction loop



LA-90 SET

Induction loop amplifier set for desk with microphone and wired handset telephone



- Compatible: - hearing aids
- cochlear implants
- inductive receivers
- Suitable for public places (desk, point of sale, home, office...)
- Easy to use
- Provided with desk microphone and wired handset telephone
- EN 60118-4 compliant

- LA-90 SET is made of LA-90 amplifier + desk microphone (LCM-11) + wired handset telephone (COMBINE LA90).
- It is suitable for public place in order to facilitate communication with hearing loss person.
- Installation is quick and easy, you have to put the device between you and the paired person who set his protheses on "T" or "MT" position.
- For no paired person, it is possible to use the wired handset telephone.
- The voice picking is performed by the desk microphone avoiding larsen and use in poor acoustic conditions.
- Desk microphone level can be adjustable by a knob and it is supplying by LA-90 and doesn't need battery.
- Handset telephone and microphone are powered as soon as LA-90 is turned on.
- For stationary use, the device can be screwed to the countertop, wall or locked by a Kensington™ lock.



LA-90 rear panel

Model	LA-90 SET
Autonomy	6h on battery
Magnetic field distance	1m
Integrated microphone	SPL max 60dB
Audio input / output	External MIC input: Jack 3,5mm with adjustable level / Headphone output: Jack 3,5mm with adjustable level
Control	3 position: internal mic / external mic / both mic
Microphone station	Directional with gooseneck supplying by LA-90
Power source	100 - 240V AC 50 - 60Hz / 16V DC or integrated battery 12V
Ergonomic handset	Wired to LA-90 by spiral cord
Dimensions (WxHxD) (mm)	LA-90: 185 x 200 x 70 / Handset: 45 x 215 x 45 / Desk microphone: base: 140 x 150 x 20 - Gooseneck: - 370
Provided accessories	Battery - Power supply - 1 black insert - 4 cross ear stickers - 1 template
Weight	LA-90: 635g with battery - microphone: 453g - handset: 155g

Induction loop



LA-90

Portable induction loop system for desk



- Compatible: - hearing aids
- cochlear implants
- inductive receivers
- Suitable for public places (desk, point of sale, home, office...)
- Easy to use
- Customizable insert
- EN 60118-4 compliant

- Portable induction loop LA-90 is intended for people with hearing loss. It is ready to use right away: at the hotel reception desk, an information counter or when you're out shopping. In short: anywhere where it's important for you to hear what is being said.
- Installation is quick and easy, you have to put the device between you and the paired person who set his protheses on "T" or "MT" position.
- For no paired person, it is possible to use the stethoscopic receiver LPU-1.

- To pick up external sound, the LA-90 is equipped with an integrated microphone as well as a connection jack for an external microphone.
- External microphone level can be adjustable by a knob.
- A 3,5mm Jack allows you to connect headphones.
- For stationary use, the device can be screwed to the countertop, wall or locked by a Kensington™ lock.

Model	LA-90
Autonomy	6h on battery
Magnetic field distance	1m
Integrated microphone	SPL max 60dB
Input / Output	Jack 3,5mm MIC input with adjustable level - Jack 3,5mm headphones output with adjustable level
Control	3 position: internal mic / external mic / both mic
Power source	100 - 240V AC 50 - 60Hz / 16V DC or integrated battery 12V
Dimensions (WxHxD)	185 x 200 x 70mm
Colour	silver-metallic
Provided accessories	Battery - Power supply - 3 inserts (blue, bordeaux, yellow) - 4 crossed ear stickers - 1 template
Weight	635g (with battery)

Accessories



LCM-11 Desk microphone

- Gooseneck microphone with male XLR connection.
- Supplied with a 1,80m cord, a female XLR connector on the microphone side and a 3,5 mono jack for the amp side.



COMBINE LA90 Handset telephone

- Supplied with the black band that attaches to the LA-90 which contains a small notch at the top to hold the handset.
- 3,5mm jack connector.





CRESCENDO 60 M Universal audio amplifier

- The CRESCENDO 60 M is an universal audio amplifier also designed for the reception of inductive audio signals.
- It is designed for televisions, radios and to facilitate conversations.
- The user receives the sound via a light and comfortable stethoscopic headset and can adjust the volume and the tone according to his preferences.
- The CRESCENDO 60 M can also be used as a pocket receiver for inductive audio signals transmitted via induction loop systems.

The CRESCENDO 60 M set includes:

- CRESCENDO 60 M
- Ultralight DIR stethoscopic headset
- Fastening clip and lanyard
- External microphone with 1.2 m cable
- 3m extension cable
- Carry strap and belt clip
- 2 AA 1.5 V batteries for 75 hours of operation



Model	CRESCENDO 60 M
Power supply	2 x 1.5V AA batteries for 75 hours of operation
Dimensions (WxHxD)	62 x 95 x 25mm
Weight	120g



PROLOOP C: induction loop amplifier for areas up to 170m²

Compliant with
IEC 60118-4



- The PROLOOP C is designed for professional use in medium-sized rooms (up to 170 m²), in which particularly high dependability and extremely reliable operation are required.
- The PROLOOP C is 100-percent short-circuit-proof thanks to its automatic resettable protection.
- Each of the two XLR3 inputs can be configured as LINE (balanced) or as microphone input (unbalanced).
- On MIC mode it is possible to activate the function: gain control and 40V phantom power for condenser microphones. Signal of each input are stabilized by AGC.

- Automatic Gain Control (AGC) guarantees consistent field strength and current on the cable loop.
- Monitoring output allows to chain the amplifier to another loop amplifier or other audio equipment requiring the same audio signal.

Model	PROLOOP C
Power	7 - 200W
Protection	Passive: 10A fuse - Active protection against short-circuit
Coverage	170m ² acc. to IEC 60118-4, single-loop, free field
Max. voltage	31 V peak to peak
Max. current	60A peak to peak of 1-5ms, 4 A RMS @ 1kHz
AGC output	Sets voltage and power for steady signals like oscillation and sine curves after 0.6-1 seconds to -10dB. Short pulses and normal program signals are not limited
Connector	Screw terminal
Bandwidth	100 to 5,000Hz (± 3dB)
Distortion	< 1%
Line Out	Monitoring output 0dBm-RCA
Headphones output	Jack 6.35mm
Inputs	IN 1 and 2: 0.5mV-100mV / 10kΩ (mic.) alt. 25mV - 4 V/ 10kΩ (line) AGC, switchable phantom voltage, XLR connections; IN 3: 50mV-10V / 10kΩ, RCA connection
Audio inputs	Dynamic > 70dB
AGC	Rise time 2 - 500ms Fall time 0.5 - 20dB/s
Control	Gain control: IN1, IN2, IN3 - Treble control: 0 - +9dB - Induction loop adjustment: 0 - 170 m ²
Display	Mains connection: 1 green LED ; Input level: 1 green LED ; Induction loop power: 1 green LED
Power source	230 - 240VAC 50/60Hz
Dimensions (WxHxD)	295 x 64 x 205mm
Provided accessories	19" rack mount bracket
Weight	3.6kg

Section of the loop cable: the section of the cable to be connected to the induction loop amplifier depends on the total length of cable required in the loop and its connection to the induction loop amplifier. For a system with low crosstalk cable length is important because of the pose in several segments. Do not hesitate to contact us before any installation.

Encircle area	Recommended cable cross-section
150 - 300m ²	2.5mm ²
70 - 150m ²	1.5mm ²
≤ 70m ²	1.0mm ²



MALLETTE PROLOOP C

Portable induction loop case



- Complete set up to 125m²
- Extensible up to 170m² with optional additional cable

- The **MALLETTE PROLOOP C** contains a complete and portable induction loop system to equip surfaces of 125m² maximum.
- It is possible to increase surfaces up to 170m² thanks to an optional 12m cable.
- This set includes 1 PROLOOP C amplifier, 2 cable rollers of 20m each (for induction loop), 2 connection cords 1m and 5m, magnetic field meters PROLOOP FSM PLUS and 1 screw driver.

- Strong and compartmentalized case
- Quick and easy installation

- The principle is to place the two rollers in the length of the room (left and right) and connect the two rollers with the connection cable. The loop thus formed is connected to the amplifier.
- **PROLOOP C** amplifier (see data sheet) has 2 XLR3 inputs configurable as needed either audio input or microphone input. For MIC input it is possible to activate gain adjustment function and 40V phantom power. 1 LINE input on RCA allows you to connect directly devices equipped with RCA output.

Model	MALLETTE PROLOOP C
Coverage	125m ² CEI 60118-4 (170m ² with optional additional cable)
Colour	Silver-metallic
Dimensions (WxHxD)	610 x 210 x 360mm
Provided items	PROLOOP C, 2 cable rollers of 20m each, 2 connection cords 1m and 5m, PROLOOP FSM PLUS and 1 screw driver
Weight	11kg



The **PROLOOP FSM PLUS** (see p.312), included into the package, determines magnetic field and comply the installation with the CEI 60118-4 Standard

PROLOOP NX3 : Induction loop amplifier for areas up to 56 m²



- The PROLOOP NX3 is designed for small-sized rooms (up to 56 m²). It is primarily designed for continuous use. The integrated switch mode power supply and the Class-D amplifier design enable high efficiency and low waste heat. Among other things, this results in the high reliability and operational safety .
- Automatic Gain Control (AGC) ensures a consistent level on the listening loop.
- Metal Loss Correction (MLC) can be used to correct the frequency response due to metal structures.
- The balanced input 1 can be switched between microphone and line sensitivity. It also provides 48V phantom power for condenser microphones
- The unbalanced input 2 handles line level signals or the audio signal of an electret microphone.
- Input 3 is specially designed for connecting media players via a 3.5 mm stereo jack. Stereo signals are summed to mono.



Rear panel

Model	PROLOOP NX3
Coverage	56 m ²
Power supply	100-240 V AC 50/60 Hz
Power consumption max.	30 W
Metal Loss Correction (MLC)	0-4 dB/Octave
Cooling	fanless
Dimensions (HxBxD)	32 x 167 x 95 mm
Weight	0.37 kg
Amplifier output	
Loop current max.	2,5 A RMS
Loop voltage max.	12 V RMS
Frequency range (± 1,5 dB)	80 Hz - 6 kHz
Loop resistance DC	0,2 - 1,0 Ω
Output	
Loop connection	2 pol. Euroblock plug
Inputs	
Input 1	5-20 mV / 2 kΩ / 48 V (MIC), balanced 100 mV - 2 V / 10 kΩ (LINE) balanced switchable, 3 pol. Euroblock plug
Input 2	5-20 mV / 2 kΩ / 5 V (MIC) unbalanced 3,5 mm stereo Jack 100 mV - 2 V / 10 kΩ (LINE) unbalanced 3 pol. Euroblock plug
Input 3	316 mV - 6 V / 10 kΩ (LINE) unbalanced 3,5 mm stereo Jack
Automatic Gain Control (AGC)	
AGC	voice-optimised
Dynamic range	>40 dB



PROLOOP NX7 : Induction loop amplifier for areas up to 420 m²

- The PROLOOP NX7 is designed for areas up to 420 m². It is primarily designed for continuous use. The integrated switch mode power supply and the Class-D amplifier design enable high efficiency and low waste heat. Among other things, this results in the high reliability and operational safety.
- The function of the induction loop and the amplifier is continuously monitored. A functional error is indicated via displays on the unit and at the error output.
- Automatic Gain Control (AGC) ensures a consistent level on the listening loop
- Metal Loss Correction (MLC) can be used to correct the frequency response due to metal structures present in the building.
- Link connections allow several PROLOOP NX Amplifiers to be combined into one unit.



Rear panel

- The output signal can be monitored via a headphone output.
- A screw-fixed cover plate prevents the setting from being

changed.

- The power switch on the back prevents the unit from being switched off unintentionally.

Model	PROLOOP NX7
Coverage	420 m ²
Power supply	110-265 V AC 50/60 Hz
Power consumption max.	225W
Metal Loss Correction (MLC)	0-4 dB/Octave
Cooling	fanless
Dimensions (HxBxT)	43 x 430 x 290 mm 19" 1U
Weight	3.72 kg
Amplifier output	
Loop current max.	7 A RMS
Loop voltage max.	34 V RMS
Frequency range (± 1,5 dB)	80 Hz - 6 kHz
Loop resistance DC	0,5 - 3,0 Ω
Outputs	
Headphone	3,5 mm stereo Jack
Link connections	6,3 mm Jack, balanced
Status connection	3 pol. Euroblock plug
Loop connection	NL4 Speakon Twist 1+ parallel to 2+ / 1- parallel to 2-
Inputs	
Input 1	5-100 mV / 2 kΩ / 48 V switchable (MIC) 100 mV - 6 V / 10 kΩ (LINE) switchable, Combo Jack
Input 2	5-100 mV / 2 kΩ / 48 V switchable (MIC) 100 mV - 6 V / 10 kΩ (LINE) switchable, Euroblock plug
Input 3	100 V Priority input 2 pol. Euroblock plug
Link in/out/out 90°	6,3 mm Jack, balanced
Automatic Gain Control (AGC)	
AGC	voice-optimised
Dynamic range	>40 dB



PROLOOP NX15 : Induction loop amplifier for areas up to 1 400 m²

- The PROLOOP NX15 is designed for areas up to 1 400 m². It is primarily designed for continuous use. The integrated switch mode power supply and the Class-D amplifier design enable high efficiency and low waste heat. Among other things, this results in the high reliability and operational safety.
- The function of the induction loop and the amplifier is continuously monitored. A functional error is indicated via displays on the unit and at the error output.
- Automatic Gain Control (AGC) ensures a consistent level on the listening loop
- Metal Loss Correction (MLC) can be used to correct the frequency response due to metal structures present in the building.
- Link connections allow several PROLOOP NX Amplifiers to be combined into one unit.



Rear panel

- The output signal can be monitored via a headphone output.
- A screw-fixed cover plate prevents the setting from being

changed.

- The power switch on the back prevents the unit from being switched off unintentionally.

Model	PROLOOP NX15
Coverage	1 400 m ²
Power supply	110-265 V AC 50/60 Hz
Power consumption max.	450W
Metal Loss Correction (MLC)	0-4 dB/Octave
Cooling	fanless
Dimensions (HxBxT)	43 x 430 x 290 mm 19" 1U
Weight	3.72 kg
Amplifier output	
Loop current max.	14 A RMS
Loop voltage max.	34 V RMS
Frequency range (± 1,5 dB)	80 Hz - 6 kHz
Loop resistance DC	0,5 - 3,0 Ω
Outputs	
Headphone	3,5 mm stereo Jack
Link connections	6,3 mm Jack, balanced
Status connection	3 pol. Euroblock plug
Loop connection	NL4 Speakon Twist 1+ parallel to 2+ / 1- parallel to 2-
Inputs	
Input 1	5-100 mV / 2 kΩ / 48 V switchable (MIC) 100 mV - 6 V / 10 kΩ (LINE) switchable, Combo Jack
Input 2	5-100 mV / 2 kΩ / 48 V switchable (MIC) 100 mV - 6 V / 10 kΩ (LINE) switchable, Euroblock plug
Input 3	100 V Priority input 2 pol. Euroblock plug
Link in/out/out 90°	6,3 mm Jack, balanced
Automatic Gain Control (AGC)	
AGC	voice-optimised
Dynamic range	>40 dB



PROLOOP NX7 LOS : Induction loop amplifier for areas up to 1 200 m² (low crosstalk)

- The PROLOOP NX7 LOS is designed for areas up to 1 200 m². It is primarily designed for continuous use. The integrated switch mode power supply and the Class-D amplifier design enable high efficiency and low waste heat. Among other things, this results in the high reliability and operational safety.
- The function of the induction loop and the amplifier is continuously monitored. A functional error is indicated via displays on the unit and at the error output.
- Automatic Gain Control (AGC) ensures a consistent level on the listening loop.
- Metal Loss Correction (MLC) can be used to correct the frequency response due to metal structures present in the building.



Rear panel

- Link connections allow several PROLOOP NX Amplifiers to be combined into one unit.
- Loop output B can be switched between 0° or 90° phase shift.
- The output signal of both amplifier channels can be monitored via a switchable headphone output.
- A screw-fixed cover plate prevents the setting from being changed.
- The power switch on the back prevents the unit from being switched off unintentionally.

Model	PROLOOP NX7 LOS
Coverage	1 200 m ²
Power supply	110-265 V AC 50/60 Hz
Power consumption max.	450W
Metal Loss Correction (MLC)	0-4 dB/Octave
Cooling	fanless
Dimensions (HxBxT)	43 x 430 x 290 mm 19" 1U
Weight	3,8 kg
Amplifier output	
Loop current max.	2x 7 A RMS
Loop voltage max.	2x 34 V RMS
Frequency range (± 1,5 dB)	80 Hz - 6 kHz
Loop resistance DC	0,5 - 3,0 Ω
Outputs	
Headphone	3,5 mm stereo Jack
Link connections	6,3 mm Jack, balanced
Status connection	3 pol. Euroblock plug
Loop connection	NL4 Speakon Twist 1+ parallel to 2+ / 1- parallel to 2-
Inputs	
Input 1	5-100 mV / 2 kΩ / 48 V switchable (MIC) 100 mV - 6 V / 10 kΩ (LINE) switchable, Combo Jack
Input 2	5-100 mV / 2 kΩ / 48 V switchable (MIC) 100 mV - 6 V / 10 kΩ (LINE) switchable, Euroblock plug
Input 3	100 V Priority input 2 pol. Euroblock plug
Link in/out/out 90°	6,3 mm Jack, balanced
Automatic Gain Control (AGC)	
AGC	voice-optimised
Dynamic range	>40 dB



PROLOOP NX15 LOS : Induction loop amplifier for areas up to 3 400 m² (low crosstalk)

- The PROLOOP NX15 LOS is designed for areas up to 3 400 m². It is primarily designed for continuous use. The integrated switch mode power supply and the Class-D amplifier design enable high efficiency and low waste heat. Among other things, this results in the high reliability and operational safety.
- The function of the induction loop and the amplifier is continuously monitored. A functional error is indicated via displays on the unit and at the error output.
- Automatic Gain Control (AGC) ensures a consistent level on the listening loop.
- Metal Loss Correction (MLC) can be used to correct the frequency response due to metal structures present in the building.



Rear panel

- Link connections allow several PROLOOP NX Amplifiers to be combined into one unit.
- Low output B can be switched between 0° or 90° phase shift.
- The output signal of both amplifier channels can be monitored via a switchable headphone output.
- A screw-fixed cover plate prevents the setting from being changed.
- The power switch on the back prevents the unit from being switched off unintentionally.

Model	PROLOOP NX15 LOS
Coverage	3 400 m ²
Power supply	110-265 V AC 50/60 Hz
Power consumption max.	900W
Metal Loss Correction (MLC)	0-4 dB/Octave
Cooling	fan-cooled, temperature controlled
Dimensions (HxBxT)	43 x 430 x 290 mm 19" 1U
Weight	3,8 kg
Amplifier output	
Loop current max.	2x 14 A RMS
Loop voltage max.	2x 34 V RMS
Frequency range (± 1,5 dB)	80 Hz - 6 kHz
Loop resistance DC	0,5 - 3,0 Ω
Outputs	
Headphone	3,5 mm stereo Jack
Link connections	6,3 mm Jack, balanced
Status connection	3 pol. Euroblock plug
Loop connection	NL4 Speakon Twist 1+ parallel to 2+ / 1- parallel to 2-
Inputs	
Input 1	5-100 mV / 2 kΩ / 48 V switchable (MIC) 100 mV - 6 V / 10 kΩ (LINE) switchable, Combo Jack
Input 2	5-100 mV / 2 kΩ / 48 V switchable (MIC) 100 mV - 6 V / 10 kΩ (LINE) switchable, Euroblock plug
Input 3	100 V Priority input 2 pol. Euroblock plug
Link in/out/out 90°	6,3 mm Jack, balanced
Automatic Gain Control (AGC)	
AGC	voice-optimised
Dynamic range	>40 dB



LPU-1: induction loop receiver

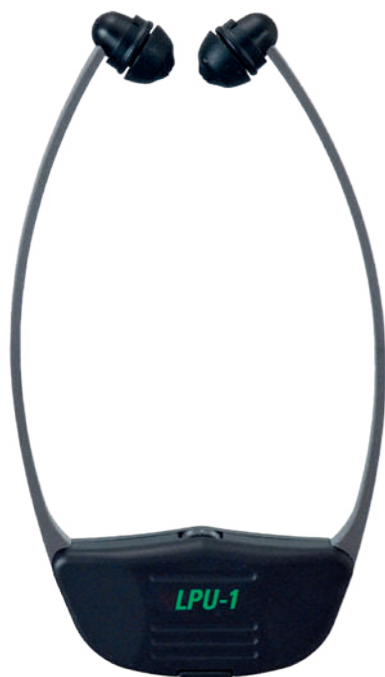

- The LPU-1 stethoscopic induction loop receiver is intended to be used by people who do not wear hearing aids.
- Lightweight and easy to use, it is designed to be used in all places equipped with induction loop as churches, meeting rooms, theaters...

Model	LPU-1
Autonomy	6 - 8h depends on the volume
Bandwidth	70 - 5,400Hz
THD	< 1%
S/N ratio	60dB
Maximum SPL	120dBA
Control and display	On/Off by spreading temple - 1 On/Off LED - 1 volume wheel
Power source	1 battery A100NIMH 180mAh
Dimensions (WxHxD)	115 x 205 x 20mm
Colour	Black case and grey temple
Provided accessories	1 battery AP11A - 1 protective cover for volume control
Weight	41g - 53g with battery

Charging decks for LPU-1

Model	STATION POUR LPU-1	STATION 5 LPU-1
Colour	Black	
Compartments	Compartments for one receiver and 2 batteries	5 compartments for 5 receivers in stand up position
Power source	power supply 230V AC / 12V DC	
Dimensions (WxHxD)	162 x 30 x 100mm	310 x 30 x 160mm
Weight	643g with power supply	850g with power supply

STATION POUR LPU-1



STATION 5 LPU-1



Cases

MALLETTE LPU1

This case can contain 1 or 2 charging decks for 5 LPU-1 and up to 10 LPU-1 receivers. Charging decks and LPU-1 receiver to be ordered separately.

MALLETTE 15 LPU-1

- This aluminium case allows you to store and transport up to 15 LPU-1 on 3 shelves.
- A second configuration with 2 shelves, 1 foam (ref. **MOUSSE MALLETTE**) and 2 charging decks (ref. **STATION 5 LPU-1**) allows you to store and recharge 10 receivers LPU-1.
- Case is provided without shelf, without foam and without charging deck. Contents should be ordered separately.

Silicone tips



Ref. **EMBOUTS 24 PAIRES**

Spare battery



Ref. **ACCU A100 LPU-1**



RCI-102: stethoscopic infrared receiver (mono or stereo)



- This light and ergonomically designed stethoscopic receiver is equipped with swivelling earpieces, which means that the earpieces retain their position in the ear even when the user turns his/her head. The flexible material used to make the ear buds also nestles gently into the auditory canal to effectively subdue any ambient noise.
- The RCI 102 is equipped with a switch to select the frequency channels. Both channels are constantly active for stereo transmissions. If the event organizer uses both the 2.3MHz and the 2.8MHz frequency ranges to transmit in two different languages at the same time, the listener can select the channel in his/her preferred language and receive the information in mono mode.

Model	RCI-102
Autonomy	~ 5h
Bandwidth	15 to 20,000Hz
THD	< 1%
S/N ratio	60dB
SPL max.	~ 120dBA
Control	On/Off by spreading temple - 1 volume wheel - Balance can be adjusted with the help of a screwdriver
Power source	1 battery A100 NIMH
Dimensions (WxHxD)	115 x 205 x 20
Colour	Black case and grey temple
Provided accessories	1 battery A100 NIMH
Weight	52g with battery

Charging decks for 1 ou for 5 RCI-102 are the same than for LPU-1 ([see p.310](#)):

STATION POUR LPU-1



STATION 5 LPU-1



CASQUE IR IP112: headphones with 2-channel IR-receiver (mono or stereo)

- The wireless headset with 2-channel IR-receiver is suitable for the operation with transmitters operating on 2.3 or 2.8MHz. It reproduces audio signals in excellent sound quality.
- The easy to operate headset is equipped with a number of comfort functions including the adaptation of the sound pattern to individual listening preferences. The volume can be individually regulated on each side of the headset.

Model	CASQUE IR IP112
Autonomy	20h
Receiver frequencies	2.3MHz & 2.8MHz (can be switched)
Reception Mode	360°
Modulation	FM wide range
Bandwidth	60Hz to 12kHz ± 3dB
S/N ratio	54dB not weighted
Power supply	2x AAA alkaline batteries
Operating elements	ON/OFF, volume regulation left and right, channel selector switch
Colour	Black
Weight	200g





PROLOOP FSM PLUS: magnetic field measurement device



- EN 60118-4:2006 compliant
- 2 modes: measurement of parasite magnetic field measurement of magnetic field strength in induction loop
- RMS measurement set to 400 mA/m = 0dB
- Display: field strength via LED-scale
- Headphones output with adjustable volume
- The PROLOOP FSM PLUS is a measuring device that measures the magnetic field strength of induction loop systems according to IEC 60118-4:2006 and BS 6083, Para. 4.
- The device is designed for professional used and delivers reliable RMS values on the output level, response frequency, AGC function (Automatic Gain Control), distortion and background noise in the induction looped tested.
- In addition, it enables the user to make an acoustic evaluation of the sound using signal reproduction via earphones.

Model	PROLOOP FSM PLUS
True RMS	125ms average
Measuring range	+ 6dB to - 40dB (0dB = 400mA/m)
Headphone out	Jack 3.5mm
Control	Measurement scale selection: 0dB/-30dB - Headphones level control
Display	Battery status control via LED - Field strength: via LED-scale (approx. 1dB resolution) / 1 LED = 1dB
Standard	Compliant with IEC 60118-4:006 and BS for testing equipment used to evaluate induction loop systems
Power supply	2x AA alkaline batteries 1.5V
Dimensions (WxHxD) (mm)	83 x 126 x 35
Colour	dark grey
Provided accessories	2 AA batteries - One test CD with normalized signals
Weight	170g

Listening Accessories

Lightweight headphones



Ref. CASQUE LÉGER

Stethoscopic headphones with ergonomic earpiece



Ref. CASQUE STÉTHO

Stereo headphones disposable, 1.2m cord (10 pcs)



Ref. ECOUTEURS JETABLES



PR-22+: combined 2-channel infrared or induction loop signal receiver



- The PR-22+ (with AGC, Automatic Gain Control) is equipped with two receiver modules for induction loop signals and for infrared signals.
- The 3.5mm audio Jack makes it possible to connect variety of different listening components, such as an under-the-chin receiver, ear or headphones, a teleloop or monaural/binaural cords.
- PR-22+ operating on batteries, a charging deck is advisable.

Model	PR-22+
Bandwidth	15 - 20,000Hz
THD	< 1%
S/N ratio	60dB
Maximum SPL	120dBA
Control	On/Off switch - Tonality and volume adjustment wheels Reception mode switch (induction loop/ infrared)
Power source	2 batteries 1.2V 750mAh AAA
Dimensions (LxHxP)	75 x 68 x 22mm
Colour	black
Provided accessories	1 combined receiver - 2 1.2V 750 mAh AAA batteries - 1 necklace
Weight	~ 60g (with batteries)

Charging decks for PR-22+

Model	STATION 1 PR-22	STATION 5 PR-22
Colour	Black	
Compartments	1	5
Power source	Power supply 230V AC / 12V DC	
Dimensions (WxHxD)	137 x 38 x 89mm	325 x 60 x 260mm
Weight	110g	640g



STATION 1 PR-22



STATION 5 PR-22

Magnetic necklace

COLLIER MAGNÉTIQUE: magnetic necklace with Jack mono (cord: 50cm)



**PRO IR-400****2-channel infrared transmitter with integrated modulator**

- Wide infrared angle
- Suitable for 1 stereo transmission or 2x mono
- Modularity: several PRO IR-400 can be chained to increase the coverage surface
- Each PRO IR-400 has its own power supply
- For a static system (ceiling mount or wall) or portable (with telescopic tripod)
- The infrared transmitter with integrated modulator has a wide angle in lobed shape.
- It ensures insensitivity to extraneous light operation with frequency modulation infrared signals on 2.3 and 2.8MHz.
- The PRO IR-400 allows transmission coverage of 2600m² in single-channel mode, which makes it suitable for larger rooms.
- Coupling several PRO IR-400 can increase or multiply significantly the coverage surface. Not to mention that the choice of the type of receptor (CASQUE IR IP112, RCI-102, PR-22+) also influences the covered area.
- Fixing the PRO IR-400 is possible on a wall, ceiling or on a stand with 1/4 inch screw for a mobile application.

Model	PRO IR-400
Modulation	2.3MHz - 2.8MHz
Coverage	up to 2600m ² in mono channel mode
Bandwidth	80 to 15,000Hz
THD	< 2%
Inputs	2 audio line inputs (R and L), 2 mic inputs (L and R), 2 RCA synchronisation inputs (L and R)
Outputs	2 RCA synchronisation outputs (L and R)
Power source	230V AC 50Hz, 35VA
Dimensions (WxHxD) (mm)	540 x 286 x 159
Colour	black
Provided accessories	Power supply - Wall and ceiling bracket
Weight	1.1kg

RACK 19" 8U / 12U / 22U / 32U / 37U / 42U EX : mounted**RACK 19" 8U / 12U / 22U / 32U / 37U / 42U CF CB : mounted, tested and wired**

- 8U / 12U / 42U racks : removable rear & side panels, front glass door with key lock.
- 22U / 32U / 37U racks : removable side panels with key lock, front glass door & rear door with key lock.
- Supplied with fans (depending on model), electrifications, wheels and brackets.

Model	RACK 19" 8U	RACK 19" 12U	RACK 19" 22U	RACK 19" 32U	RACK 19" 37U	RACK 19" 42U
Number of units	8	12	22	32	37	42
Dimensions (mm) (with wheels)						
Depth	600	600	800	800	800	800
Width	600	600	600	600	600	600
Height	544	722	1 169	1 613	1 835	2 074
Number of fans	0	0	2	2	2	2
Colour	RAL 9005					RAL 9004

Racks accessories

19" solid blank panel

- Fills unused space in the rack.
- Improves cooling efficiency and optimizes airflow circulation.

Models	Height (U)	Dimensions (mm) W x D x H	Color	Material
PB 9100	1U	483 x 42 x 10	Black RAL9005	Cold rolled steel (SPCC)
PB 9200	2U	483 x 88 x 10		
PB 9300	3U	483 x 132 x 10		
PB 9400	4U	483 x 175 x 10		



PB 9100



PB 9400

19" fixed shelf

- Ideal for non-rackmount equipment.

Models	Rack depth	Dimensions (mm) W x D x H	Height (U)	Color	Material	Load capacity
PLATEAU RACK 600	600 mm	483 x 350 x 88	2U	Black RAL9005	Cold rolled steel (SPCC)	20 kg
PLATEAU RACK 800	800 mm	470 x 550 x 48	2U			90 kg



PLATEAU RACK 600

19" Reinforced fixed shelf

- Fixed shelf with reinforcement for heavy loads, ideal for batteries

Models	Rack depth	Dimensions (mm) W x D x H	Height (U)	Color	Material	Load capacity
PLAT RENF BAT 600	600 mm	470 x 350 x 48	2U	Black RAL9005	Cold rolled steel (SPCC)	90 kg
PLATEAU RENF BAT	800 mm	483 x 550 x 43	1U			120 kg



PLAT RENF BAT 600

19" sliding shelf

- Ideal for non-rackmount equipment.

Models	Rack depth	Height (U)	Depth (mm)	Color	Material	Load capacity
PLAT GLISSIERE 2U	600 mm	2U	400	Black RAL9005	Cold rolled steel (SPCC)	20 kg
PLAT GLISSIERE 800	800 mm	1U	550			35 kg



PLAT GLISSIERE 800

19" lockable drawer with handle

- Ideal for storing and protecting documentation or sensitive material in the bay.
- Equipped with key lock and handle.
- Supplied with 2 keys.

Models	Rack depth	Dimensions (mm) W x D x H	Height (U)	Color	Material
TIROIR RGMT 2U	600 mm	483 x 350 x 89	2U	Black RAL9005	Cold rolled steel (SPCC)
TIROIR 2U RACK 800	800 mm	483 x 550 x 89			



TIROIR 2U RACK 800

Accessories

DI BOX

Passive direct injection box



- DI BOX is a passive balanced box allow you to carry audio signals over long distances.
- It has an unbalanced mono jack input with parallel connection, a balanced XLR output and GND - LIFT selector to limit the "noise".

PATL-100

100V to audio line level converter



- Box for connecting a 100V audio signal source to devices with line input
- Adjustable line output level (0-5,6V at 100V input voltage), can be switched internally for other output voltages
- 100V input with plug-in screw terminal
- Balanced XLR output, impedance: 1kΩ, XLR panel plug
- Insulated plastic housing
- Galvanically isolated input and output

Model	PATL-100
Input	Screw terminal (100V)
Output	XLR, balanced
Output signal	0-15V
Operating temperature	0°C -40°C
Dimensions (WxHxD)	171 x 81 x 61mm
Weight	0,520kg

**BA HP**

Red and Black spring Speaker connector to screw terminal 2 modules.

**BA JACK 3.5MM**

Jack 3,5mm TRS female wall socket to screw terminal 1 module.

**BA JACK 6.35MM**

Jack 6,35mm TRS female wall socket to screw terminal 1 module.

**BA RJ45**

RJ45 female wall socket to screw terminal 1 module.

**BA XLR**

XLR 3P female wall socket to screw terminal 2 modules.

**BA RCA**

RCA stereo female wall socket to screw terminal 2 modules.

**BA DIN5P**

DIN 5P female wall socket to screw terminal 2 modules.

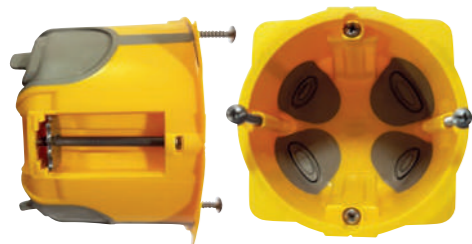
**BOITE 1 POSTE 50 MM**

In wall box for BA wall socket. Depth 50mm.

**MODULE SAILLIE BA**

On wall box for BA wall socket. Optional.

IP SPEAKERS

SIP AUDIO SYSTEM >



IP network PA solutions for every space

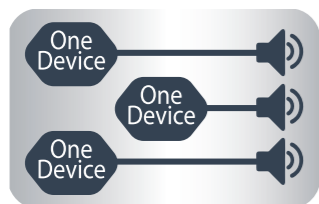

Individual zone control
 Each IP speaker is a complete audio solution. It incorporates its own powered POE/PoE+ class-D amplifier, a line output and contacts as well as a configuration and monitoring software for precise and individual control. It also reduces equipment and space requirements, unlike analog systems.

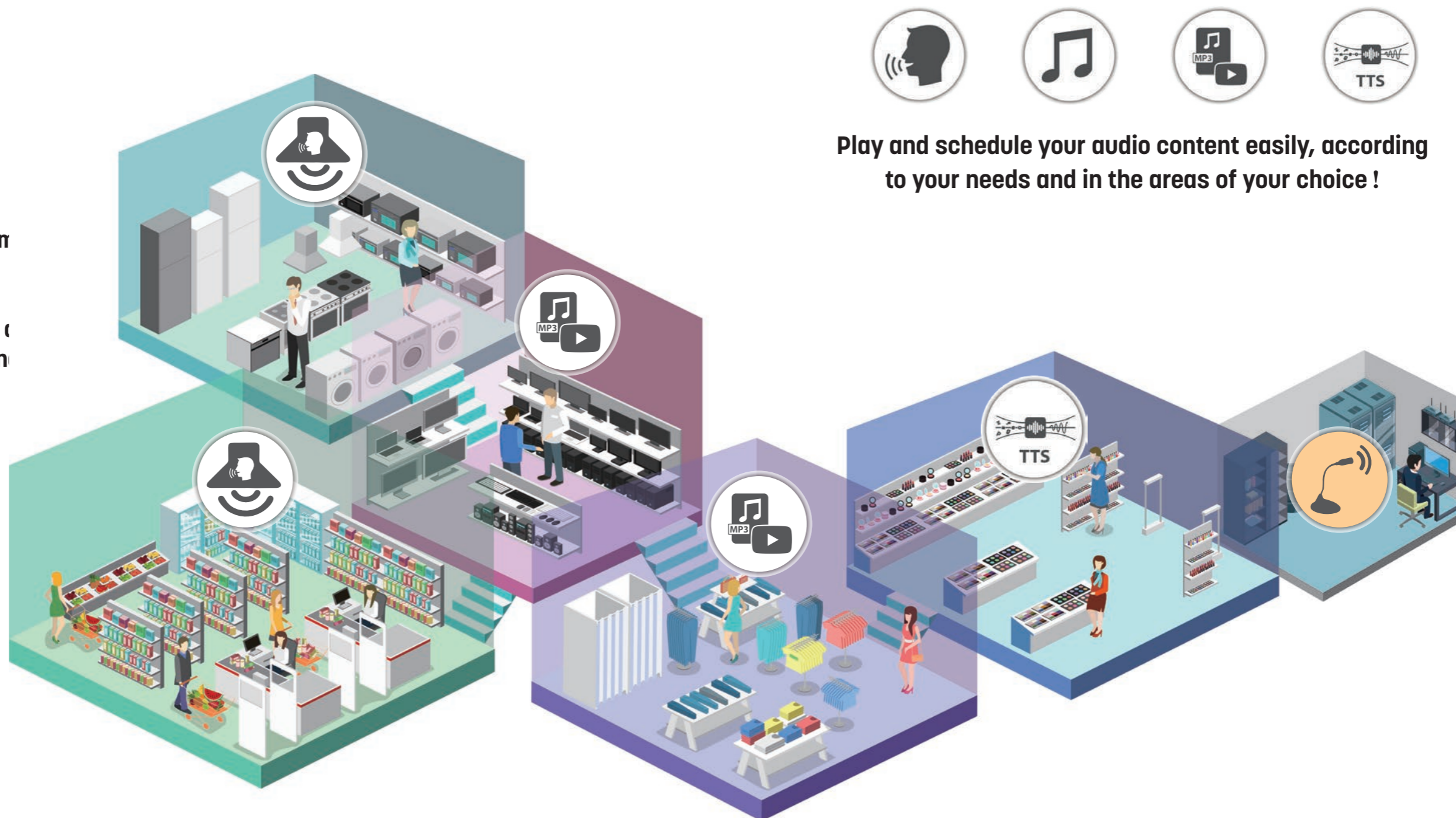

Play and schedule your audio content easily, according to your needs and in the areas of your choice !



High Audio quality
 Uncompressed/ Compressed
 High Digital audio quality format



Simple power supply
 IP speaker get power from
 POE (802.3af) or POE+
 (802.3at) switch



Interoperability
 It can be used together with
 an IP-PBX (SIP) and a CCTV
 system (VMS)



Easy plug and play
 To add an IP speaker, it only needs to be
 connected to the Ethernet network and be
 added in the software

PA made easy !

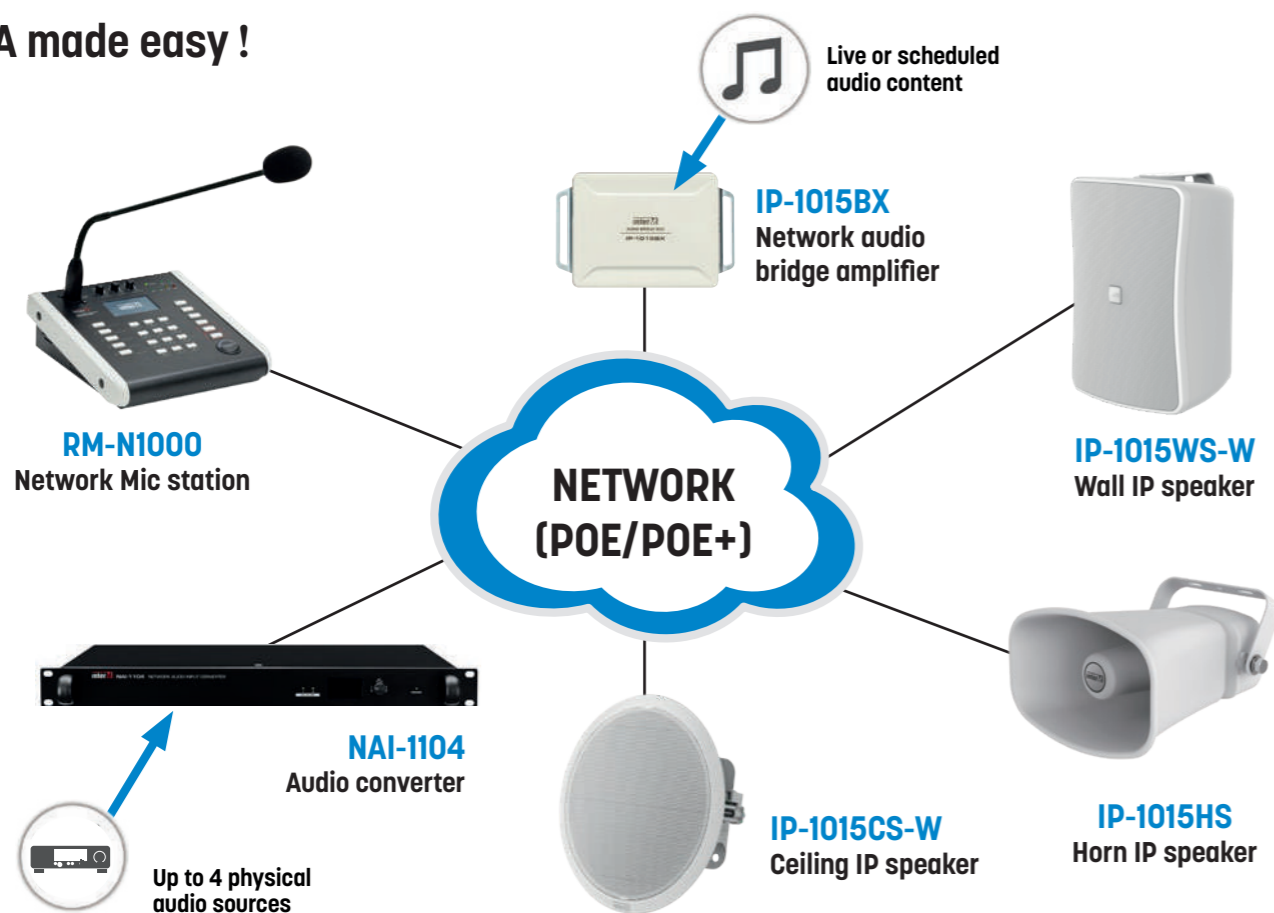

- Our IP audio system can operate and manage broadcasts via standard Ethernet networking protocols.
- Through the network, the system receives power and audio, and users can monitor and manage the system.
- The IP audio system provides an annual scheduler, a TTS and real-time monitoring features.

AOE Protocol

Through AOE (Audio Over Ethernet) protocol, it can broadcast with uncompressed format PCM(Pulse-code modulation) or compressed format MP3.

Individual zone control

- Speaker, power amplifier and remote control are integrated into one device so that the user can configure a system in which 1 speaker = 1 zone.
- This allows individual control of speakers installed in multiple zones.
- Play and schedule different content in different zones - and easily change both the zones and the content anytime, as needed, without any additional equipment or wiring modifications.

Multi-source dynamic PA control

- **Supports multi-source play up to 48 (Multicast)**
Max 24 audio sources. Max 24 remote MICs can be registered to the system.
- **IP speaker system single configuration**
Up to 256 zone control (Multicast). Up to 20 zone control (Unicast). Up to 255 groups.
- **IP speaker + IPA-100 system linkage configuration (Coming soon)**
Up to 512 zone control (Multicast). Up to 20 zone control (Unicast). Up to 255 groups.

Web GUI

Users can configure and set the system in real-time via an embedded software.

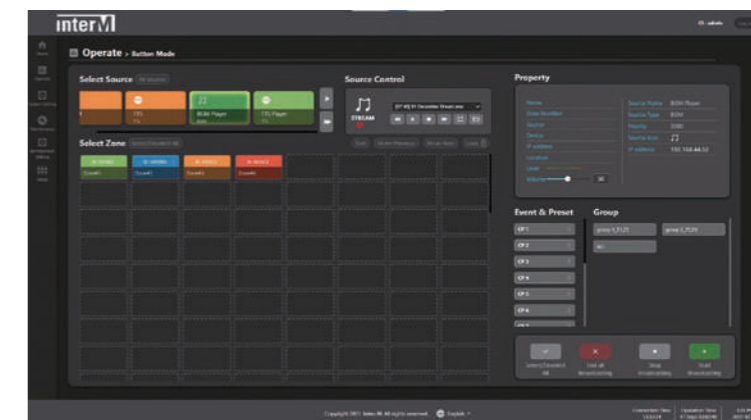

IP speaker supports two operation modes

Controller: Performs controller functions such as device/audio monitoring, operation, registration, device setting, etc.
Speaker: Performs IP speaker functions such as audio, BGM, VoIP, network settings, and system settings.

Power

Network amplifiers and IP speakers are powered via POE or PoE+.

It can output up to 3.7W with PoE and up to 10W with PoE+.

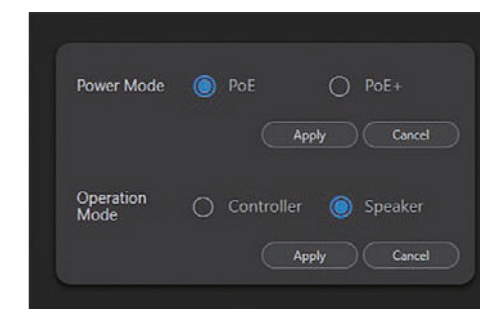

EQ function

IP speakers: optimized EQ already built-in.

IP-1015BX: equalizer provided to customizing sound.

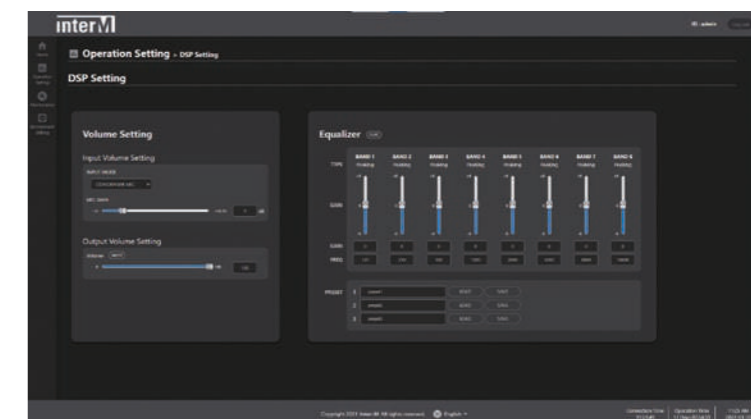

Audio monitoring by condenser MIC

Users can activate audio monitoring by built-in condenser MIC.

Users can check the broadcasting level meter by the controller's audio monitoring menu.

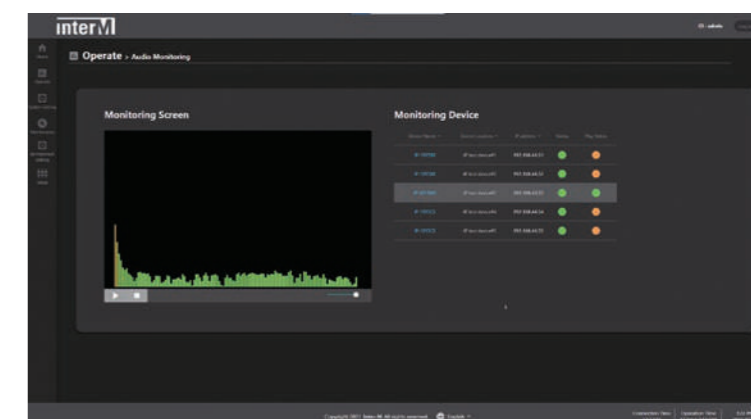

Annual Scheduler

By annual scheduler, users can make scheduled broadcasting.

Also, users can easily add, remove, manage holidays, and download/upload registered schedules by XML format.

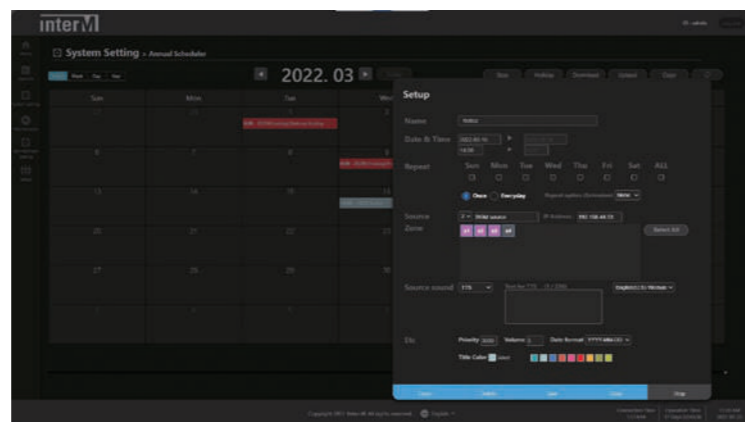

TTS (Text to Speech)

It allows users to create audio messages from any text. Users can set up 5 different languages*, Gender (Male/Female), Chime (Start, End).

Users can change the tone, delay, speed, and volume by voice option setting.

*French, English (US, UK), German, Spanish, Korean

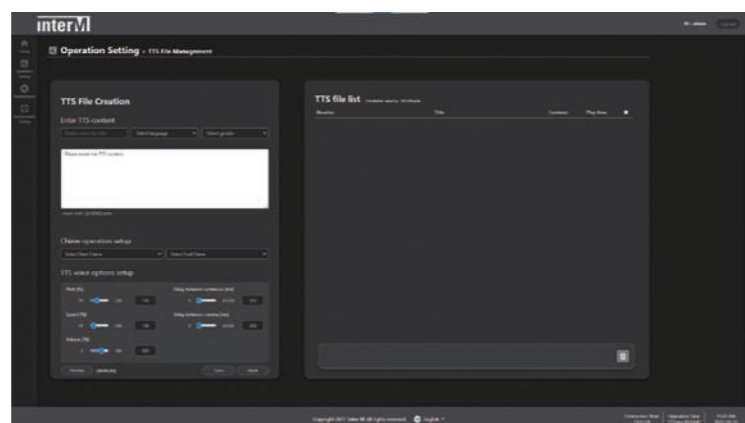

Interoperability

IP speakers can easily be integrated with an IP-PBX system (SIP protocol) or a CCTV system (VMS).

In the event of an intrusion detected by a camera, an alert message can, for example, be triggered and broadcast.

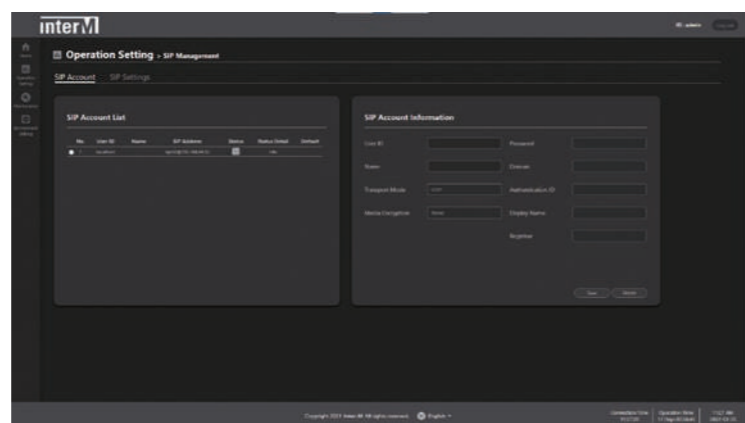

IP speakers + IP- PBX (business phone system)

IP speaker can be used alone without a separate controller. The system can be easily expanded based on a network (LAN), and paging broadcasting is possible without restrictions on location/distance.

Built-in WEB GUI enables system control and broadcast transmission through mobile devices and computers.



Offices



Schools



Warehouses



Government offices

IP speakers + VMS software (CCTV)

By integrating IP speakers with a CCTV system, users will have a complete Audio & Video solution. IP speakers help proactively prevent crime and reduce costs by reacting immediately, remotely triggering pre-recorded or live audio messages.

In response to a criminal activity detected by a camera, a pre-recorded alert message may, for example, be broadcast or a security officer may speak directly to the suspect.

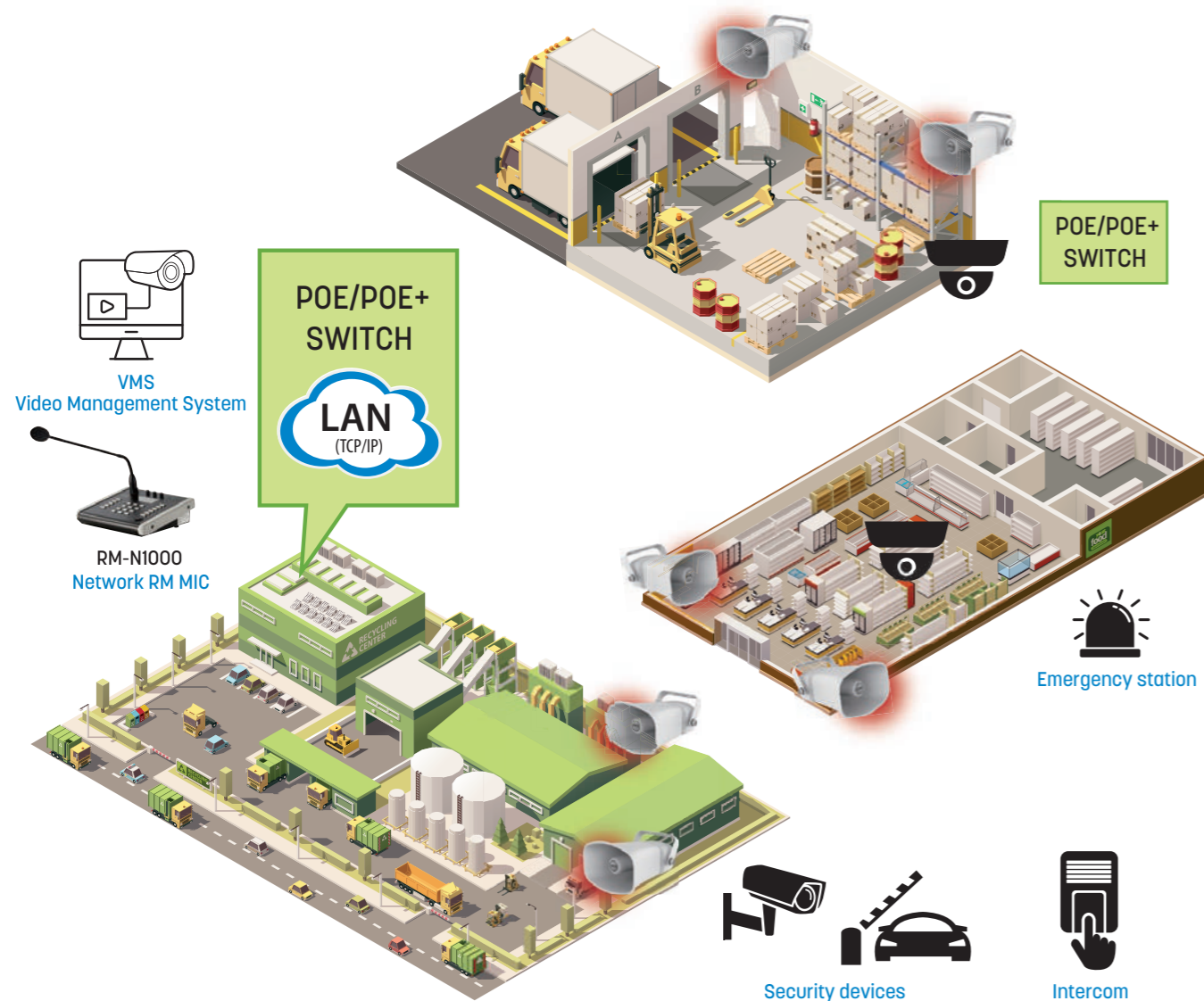

IP-1015BX Network Audio Bridge Amplifier



- Built-in 10W Class-D amplifier
- Supports PoE/PoE+
- Ethernet 10/100 BASE-TX (default IP: 192.168.1.99)
- Micro SD card slot
- Internal User Memory 1GB
- VoIP, background music, scheduler, TTS

Model	IP-1015BX
AMPLIFIER	
Rated output power (8Ω,1kHz sine wave)	3.7W (PoE), 10W (PoE+)
Frequency response (1W @ 8Ω, ±1dB)	20Hz - 20kHz
THD+N (20Hz HPF, AES17 LPF, 8Ω)	< 3%
LINE OUTPUT (X 1)	
Maximum audio output (balanced)	+6dBV ±3dB
Frequency response	20Hz - 20kHz (+1/-3dB)
THD+N (20Hz HPF, AES17 LPF)	< 0.1%
S/N (20Hz HPF, AES17 LPF, A-WTD)	> 85dB
CONTACT I/O	
Contact Input (1CH)	Dry contact
Contact Output (1CH)	Dry contact (N.O: Normally open)
STORAGE	
Memory	Internal: 1Go / External: MicroSD Max 32Go
NETWORK	
Ethernet	10/100 Base-TX
GENERAL	
Power	PoE (IEEE 802.3af type 1 Class 3) / PoE+ (IEEE 802.3at type 2 Class 4)
Operating temperature	-20°C ~ +50°C
Power consumption	PoE (IEEE 802.3af) : 44~57 VDC, Max 12.95W PoE+ (IEEE 802.3at): 50~57 VDC, Max 25.5W
Dimensions (WxHxD)	123 x 80 x 30.6mm
Weight	0.24kg



Theme parks



Train stations



Military bases



Power plants

IP-1000AB

Audio converter

NEW



IP-1000AB converts and then transmits analog audio signals into digital audio signals. You can easily send audio sources (CD player, radio tuner, etc.) to the network by using it with the IP speakers system.

- Inter-M AOE-based network audio transmitter
- Can be used with the IP speakers/IPA system
- 1CH line audio input
- WAV, MP3 file streaming available
- It is possible to integrate with external devices through contact input and output
- 1GB of internal memory for storing music sources (up to 32GB of expansion through MicroSD card)
- Device control through the Web GUI
- Support for installation of table types or walls

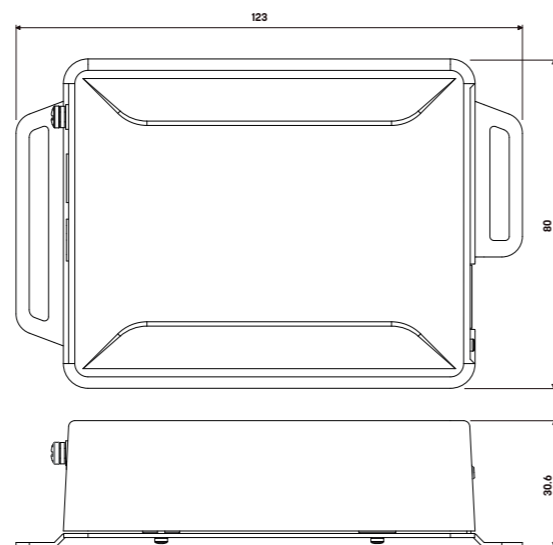
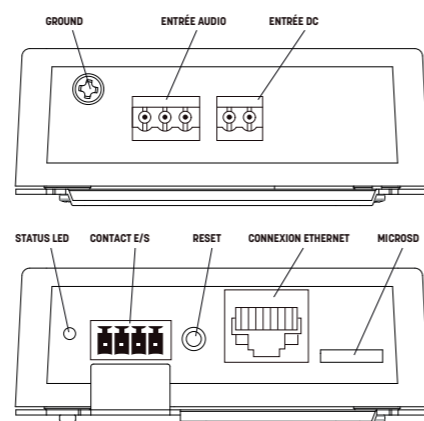

Model	IP-1000AB
AUDIO INPUT	
Maximum Input Level (Balanced)	+6dBV (2Vrms)
Frequency Response	20Hz ~ 20kHz (±3dB)
THD (@ +0dBV 1kHz Sine Wave In, IP-1015BX LINE OUTPUT, AES17 20kHz LPF)	≤ 0.05%
S/N (@ +6dBV 1kHz Sine Wave In, IP-1015BX LINE OUTPUT, AES17 20kHz LPF, A-WTD)	≥ 92dB
CONTACT I/O	
Contact Input (1CH)	Dry contact
Contact Output (1CH)	Dry contact (N.O : Normally Open)
STORAGE	
Internal	1GB
MicroSD (Not included)	Up to 32GB (SDHC)
NETWORK	
Ethernet	10/100 BASE-TX PoE
Connectors	Ethernet Jack (RJ-45)
GENERAL	
Power	PoE (IEEE 802.3af) or DC Min : 8V, Max : 28V
Operating temperature	-20°C ~ +50°C
Power Consumption	PoE (IEEE 802.3af) : 44-57 VDC, Max 90mA, DC : 8-28V, Max 320mA
Weight	0.24kg
Dimensions (WxHxD)	123 x 80 x 30.6 mm

NAI-1104

4-channel audio converter with 4 dry contacts

NEW

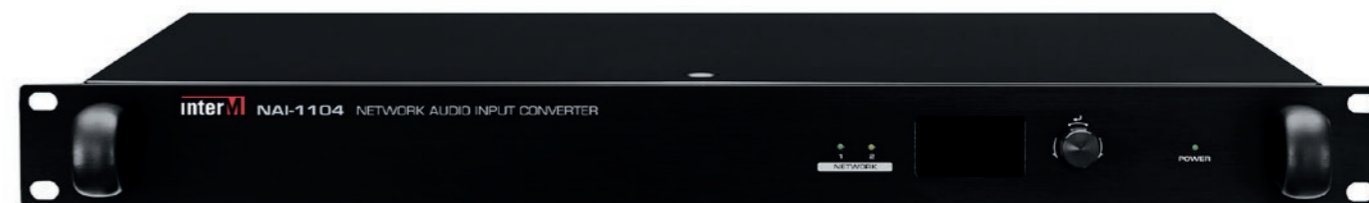

- Allows to add up to 4 physical audio sources (CD player, radio tuner, etc.).
- AC/DC power supply.
- 4 Dry contact inputs (NO: normally open) inputs for scenario triggering and activation.
- Proprietary audio and data transport protocol over network (AOE).

Model	NAI-1104
Audio input sensitivity	LINE : odBV, MIC : -60dBV
Nominal output	odBV
Phantom power	+24V / 14mA
THD @ 1kHz input, 0dBV output	LINE : < 0.04%, MIC : < 0.2%
MIC : < 0.2% S/N at 1kHz, 0dBV output, A-WTD	LINE : > 70dB, MIC : > 65dB
Bandwidth	LINE : 20Hz-20kHz, MIC : 20Hz-20kHz
Network communication	100/1000 base-T (RJ-45)
Network cable length	MAX 100m
Dry contact	4-channel input
Operating temperature	-10 ~ +40
Power supply	AC 120-240V ~, 50/60Hz, 0.43A, DC +24V, 800mA
Power consumption	22W
Weight	3.1kg
Dimensions (WxHxD)	482x 44x 280mm



Rear panel

IP-1015CS-B / IP-1015CS-W Network Ceiling Speakers

- White/Black color
- All-in-one speaker system
- 2-way 8" unit
- 10W Class-D amplifier integrated
- Supports PoE/PoE+
- Ethernet 10/100 BASE-TX (Default IP: 192.168.1.99)
- VoIP, background music, scheduler, TTS
- Internal User Memory 1GB

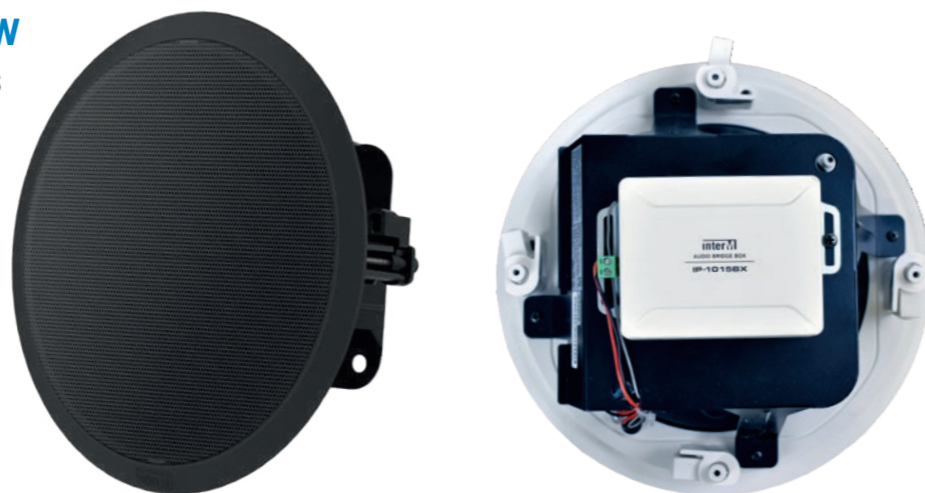

IP-1015CS-B (Black)

Rear face IP-1015CS-W (White)

Model	IP-1015CS-B / IP-1015CS-W
SPEAKER	
Type	2Way 8" Network Ceiling Speaker
Driver	LF : 8", V/C : 25.4mm / 8Ω HF : 2", V/C : 13.28mm / 8Ω
Maximum SPL	96dB (PoE 802.3af) / 99dB (PoE+ 802.3at)
Frequency Range	120Hz-20kHz
Nominal Dispersion (HxV)	1kHz : 90° / 4kHz : 60°
Enclosure	Material: ABS
AMPLIFIER	
Rated output power	3.7W (PoE 802.3af), 10W (PoE+ 802.3at)
MIC	
Embedded mic	50Hz ~ 16kHz
LINE OUTPUT	
Maximum audio output	+6dBV ±3dB
Frequency response	20Hz - 20kHz (+1/-3dB)
THD+N (20Hz HPF, AES17 LPF)	< 0.1%
S/N (20Hz HPF, AES17 LPF, A-WTD)	> 85dB
CONTACT I/O	
Contact Input (1CH)	Dry contact
Contact Output (1CH)	Dry contact (N.O: Normally open)
STORAGE	
Memory	Internal: 1Go / External: MicroSD Max 32Go
NETWORK	
Ethernet	10/100 Base-TX
GENERAL	
Power	PoE (IEEE 802.3af type 1 Class 3) / PoE+ (IEEE 802.3at type 2 Class 4)
Operating temperature	-20°C ~ +50°C
Power consumption	PoE (IEEE 802.3af) : 44-57 VDC, Max 12.95W PoE+ (IEEE 802.3at) : 50-57 VDC, Max 25.5W
Connector	Ethernet Jack (RJ-45)
Fitting hole diameter	245 mm
Dimensions (ØxH)	264 x 144 mm
Weight	1.8kg

IP-1015WS-B / IP-1015WS-W Network Wall Speakers

- White/Black color
- All-in-one speaker system
- 2-way 5" unit
- 10 W Class-D amplifier integrated
- Supports PoE/PoE+
- Ethernet 10/100 BASE-TX (Default IP: 192.168.1.99)
- VoIP, background music, scheduler, TTS
- Internal User Memory 1GB
- Mounting : U-shaped bracket
- Dustproof and waterproof (IP54)



IP-1015WS-W (White)

Rear face IP-1015WS-B (Black)

Model	IP-1015WS-B / IP-1015WS-W
SPEAKER	
Type	2Way 5" Network Wall Speaker
Driver	LF : 5", V/C : 25.4mm / 8Ω HF : 0.5", V/C : 13.4mm / 8Ω
SPL Max	96dB (PoE 802.3af) / 99dB (PoE+ 802.3at)
Frequency Range	120Hz-20kHz
Nominal dispersion (HxV)	1kHz : 180° X 120° / 4kHz : 120° X 70°
Enclosure	Type: Bass-reflex/Material: ABS
AMPLIFIER	
Rated output power	3.7W (PoE 802.3af), 10W (PoE+ 802.3at)
MIC	
Embedded mic	50Hz ~ 16kHz
LINE OUTPUT	
Maximum audio output	+6dBV ±3dB
Frequency response	20Hz - 20kHz
THD+N (20Hz HPF, AES17 LPF)	< 0.1%
S/N (20Hz HPF, AES17 LPF, A-WTD)	> 85dB
CONTACT I/O	
Contact Input (1CH)	Dry contact
Contact Output (1CH)	Dry contact (N.O: Normally open)
STORAGE	
Memory	Internal: 1Go / External: MicroSD Max 32Go
NETWORK	
Ethernet	10/100 Base-TX
GENERAL	
Power	PoE (IEEE 802.3af type 1 Class 3) / PoE+ (IEEE 802.3at type 2 Class 4)
Operating temperature	-20°C ~ +50°C
Protection	IP54
Power consumption	PoE (IEEE 802.3af) : 44-57 VDC, Max 12.95W PoE+ (IEEE 802.3at) : 50-57 VDC, Max 25.5W
Connector	Ethernet Jack (RJ-45)
Dimensions (WxHxD)	173 x 250 x 137.5mm
Weight	2.4kg

IP-1015HS Network Horn Speaker

- All-in-one speaker system
- 10W Class-D amplifier integrated
- Supports PoE/PoE+
- Ethernet 10/100 BASE-TX (Default IP: 192.168.1.99)
- VoIP, background music, scheduler, TTS
- Dustproof and waterproof (IP66)



Model	IP-1015HS
SPEAKER	
Type	Network Horn Speaker
Driver	1" Dome type (10W), V/C: 28mm, 8Ω
SPL Max	121dB (PoE 802.3af) / 124dB (PoE+ 802.3at)
Frequency Range	300Hz-5.5kHz
Nominal Dispersion(HxV)	1kHz : 110° x 140° / 4kHz : 60° x 70°
Enclosure	Material: ABS, Aluminium
AMPLIFIER	
Rated output power	3.7W (PoE 802.3af), 10W (PoE+ 802.3at)
MIC	
Embedded mic	50Hz ~ 16kHz
LINE OUTPUT	
Maximum audio output	-
Frequency response	-
THD+N (20Hz HPF, AES17 LPF)	-
S/N (20Hz HPF, AES17 LPF, A-WTD)	-
CONTACT I/O	
Contact Input (1CH)	Dry contact
Contact Output (1CH)	Dry contact (N.O: Normally open)
NETWORK	
Ethernet	10/100 Base-TX
GENERAL	
Power	PoE (IEEE 802.3af type 1 Class 3) / PoE+ (IEEE 802.3at type 2 Class 4)
Operating temperature	-40°C ~ +60°C
Protection	IP66
Power consumption	PoE (IEEE 802.3af) : 44-57 VDC, Max 12.95W PoE+ (IEEE 802.3at) : 50-57 VDC, Max 25.5W
Connector	Ethernet Jack (RJ-45)
Dimensions (WxHxD)	250 x 166 x 305mm
Weight	2.4kg

RM-N1000 Network Mic Station

- Supports Network bonding
- Power supply using POE
- Supports STATIC/DHCP



Model	RM-N1000	
MIC	Input sensitivity	-50dBV ±3dB
	Output level	+0dBV ±3dB
	S/N (<20kHzLPF, A-wt)	> 65 dB
	THD (<20kHzLPF)	< 0.1 %
	Frequency response 100Hz ~ 18kHz (Entrée : -50dBV, 1kHz)	0 dBV ±3 dB
AUX	Input sensitivity	-10dBV ± 3dB
	Output level	0dBV ± 3dB
	S/B (<20kHzLPF, A-wt)	> 75dB
	THD (<20kHzLPF)	< 0.1%
	Frequency response 100Hz ~ 18kHz (Input : -10dBV, 1kHz)	0dB ± 3dB
Network communication	Ethernet 100/1000 Base-T (RJ-45)	
Operating temperature	-10°C ~ +40°C	
Power source	24VDC	
Power consumption	Max 10W	
Dimensions (WxHxD)	200 x 73 x 206mm	
Weight	1.29kg	

RM-S1000 SIP Mic Station



RM-S1000 is a network remote microphone that allows you to paging with the IP speakers. It supports SIP, allowing two-way calls to other IP systems.

- Voice paging announcements through the network
- Can be used with Inter-M IP speaker/IPA system
- Inter-M AOE-based network audio transceiver
- SIP (Session Initiation Protocol) support
- Support eco canceler for bidirectional calls
- Audio input/output volume control
- Monitor audio output through speakers and level meters
- Powered by POE or DC24V



Model	RM-S1000	
MIC	Input sensitivity	MIC Vol. Max : -48dBV ± 3dB MIC Vol. Min : -10dBV ± 3dB
	Signal-to-noise Ratio (20kHzLPF, A-wt)	> 65dB
	THD (20kHzLPF)	< 0.1%
	Frequency Response 100Hz ~ 6kHz (Input : -48dBV, 1kHz)	0dB ± 3dB
AUX	Input sensitivity	-10dBV ± 3dB
	Signal-to-noise Ratio (20kHzLPF, A-wt)	> 75dB
	THD (20kHzLPF)	< 0.1%
	Frequency Response 100Hz ~ 18kHz (Input : -10dBV, 1kHz)	0dB ± 3dB
Network communication	100/1000 BASE-T(RJ-45)	
Operating Temperature	-10°C ~ +40°C	
Power Source	DC24V (not included) POE (IEEE 802.3af) : 44~57VDC	
Power Consumption	Max 12W	
Weight	1,3 kg	
Dimensions (W x H x D)	200 x 73 x 206 mm	

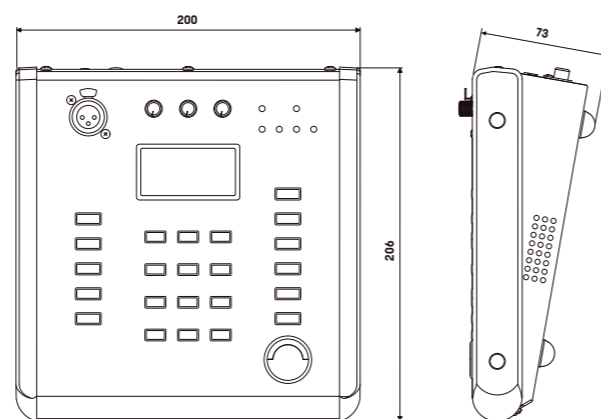
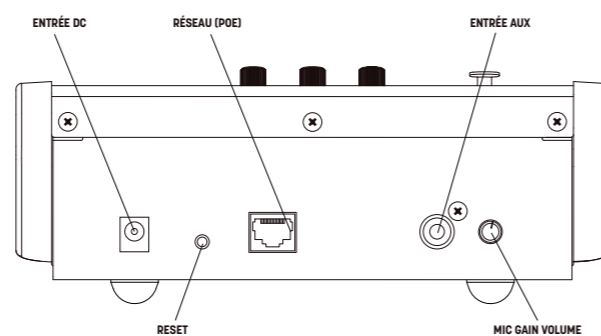

PROFESSIONAL SOUND >



CLA-200: Compact line array 200 W - 8 Ω

NEW

- The CLA-200 is a compact speaker system configured with 4 pre-assembled modules with 4 LF cone-type and 12 HF dome tweeters for high power and quality.
- The directivity is easily adjustable. 4 angles can be chosen (15, 30, 45 and 60 degrees) as needed to optimize the sound dispersion angle.
- It can be used in low (8Ω) or high impedance (200W). The optional 100V transformer (CLA-200TR) allows the CLA-200 to be connected to a 100V amplifier when the distance between the speaker and the amplifier is very long.
- The CLA-200 features an input overload protection circuitry.



- Thanks to its removable sealing plate, the system can be used both indoors and outdoors.

- It can be mounted to the wall or hung from the ceiling using optional accessories, vertically or horizontally.

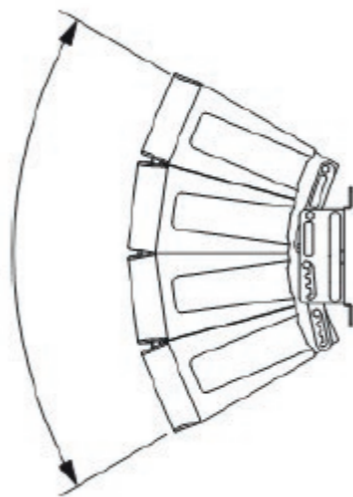

The figure shows the speaker system in 60° mode (factory-preset).

APPLICATIONS

- Auditoriums
- Houses of worship
- Stadiums
- Sport facilities

ACCESSORIES (OPTIONAL)

NEW

CLA-200CBK

- Wall or ceiling mounting bracket.



CLA-200FRAME

- Rigging frame.
- It allows the speaker to be hung from the ceiling.



CLA-200TR

- 100V transformer.



When the CLA-200TR matching transformer is installed on the CLA-200 speaker, the optional CLA-200CBK mounting bracket cannot be used.

Model	CLA-200
Enclosure	Sealed or bass-reflex (removable sealing plate)
Power Handling Capacity	Continuous pink noise : 200 W Continuous program : 600 W
Rated Impedance	8Ω
Sensitivity (1W, 1m)	96dB (60° mode) 97dB (45° mode) 98dB (30° mode) 99dB (15° mode)
Frequency Response	70 - 20,000Hz (60° mode) 75 - 20,000Hz (45° mode) 80 - 20,000Hz (30° mode) 85 - 20,000Hz (15° mode)
Crossover Frequency	4kHz
Directivity Angle	Horizontal : 100° (> 2000Hz) Vertical : 60° (> 800Hz), 45° (> 1.2kHz), 30° (> 1.6kHz), 15° (> 3.2kHz) variable
Speaker Component	Low frequency : 12cm (5") cone-type × 4 High frequency : balanced dome-type × 12
Input Terminal	2-pin connector
Water Protection	IPX4*
Finish	Polypropylene, black
Dimensions (WxHxD)	408 x 546 x 342 mm
Weight	16 kg
Operating Temperature	-15°C to +50°C
Accessories (included)	2 x suspension bracket

* Install with the every speaker module downward.

HE-12: 2-way passive multipurpose compact loudspeaker 400W - 8Ω

The HE 12 is a passive 2-way loudspeaker with a high-performance woofer and a high-power titanium driver that adapts to a wide frequency range. This full-range loudspeaker provides great clarity

- It can be used in many environments and even used as a footbath, the directivity can be adjusted to cover the necessary surface. In addition, thanks to its rotating waveguide, precise coverage can be achieved whether the loudspeaker is installed horizontally or vertically.
- Computer-simulated speaker tuning and passive crossover network tuning deliver linear frequency response, rich bass, and balanced tonal definition.

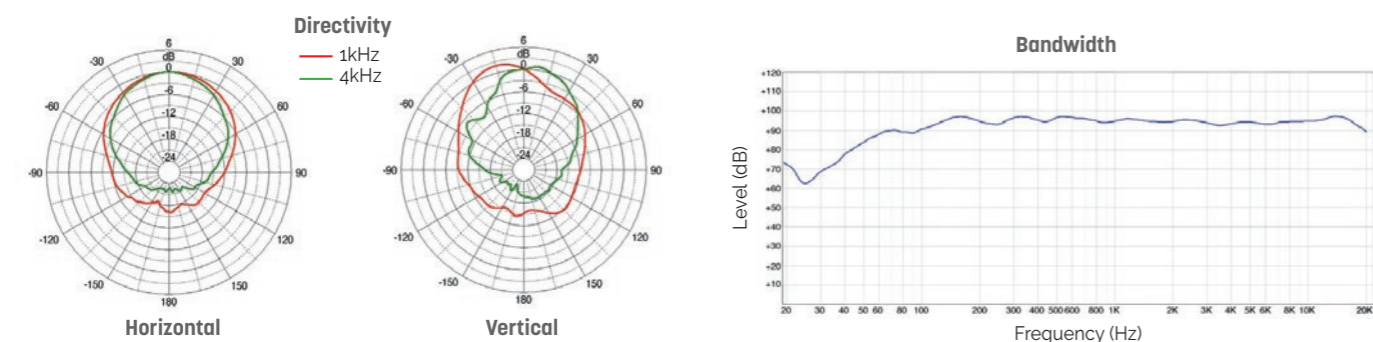
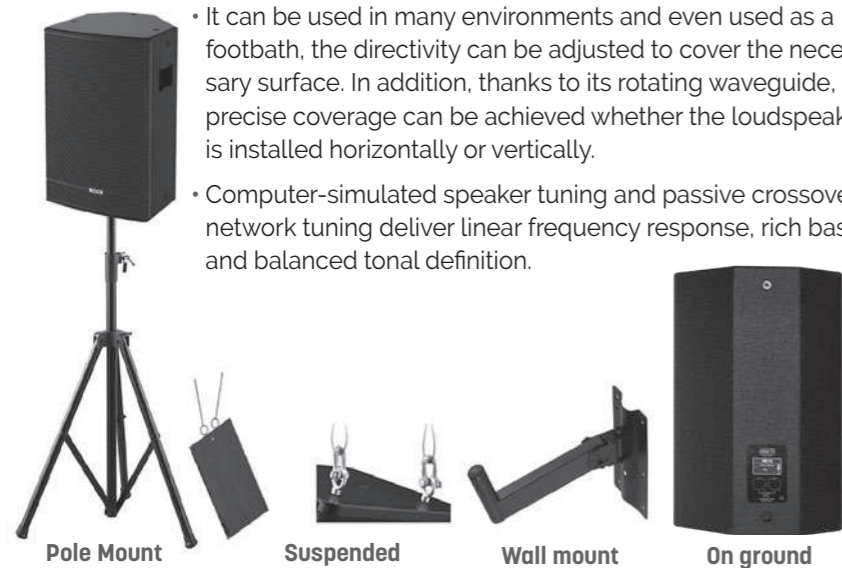

Model	HE 12
Type	12" 2Way Passive Point Source
Bandwidth (±3dB)	107Hz ~ 19,000Hz
Bandwidth (-10dB)	51Hz ~ 20,000Hz
Rated Power (AES)	400W
Rated Power (Peak)	1,600W
Sensitivity (1W/1m)	94dB
Maximum SPL (Peak)	126dB
Nominal Dispersion	70° (narrow) ~ 110°(wide) H / 30° (up) ~ 45° (down) V
Nominal Impedance	8Ω
LF Driver	12" Woofer, 3" voice coil
HF Driver	1" Tweeter, 2.03" voice coil
Horn	Asymmetrical Horn (Rotatable)
Enclosure Material	High-density MDF 15T, Polyurea Coating
Grill	SECC 15t, Powder Coating/ BLACK
Connection	2 X SPEAKON(1+,1-) [Parallel]
Fittings/Suspension	12xM10 inserts (3xtop, 3xbottom, 2xrear, 2xleft, 2xright)
Finish	Polyurea Coating
DimensionsW×H×D)	380 × 570 × 380mm
Weight (net)	26.44kg

FICHE SPEAKON NL4

HE-12 and CSB-15K input and link by 4-pole male SPEAKON plug (optional)



CSB-15K: Compact subwoofer - 600W - 8Ω

- CSB-15K is a subwoofer reproducing deep, dynamic and powerful bass, made of premium Nordic 15 ply birch plywood.
- Allowing a bass reinforcement, it incorporates on its upper face a base for the pole stand installation of full-range loudspeaker such as the HE-12.



FICHE SPEAKON NL4

HE-12 and CSB-15K input and link by 4-pole male SPEAKON plug (optional)



Model	CSB-15K
Enclosure Material	15 ply birch plywood
Transducer	15"
Nominal Power (W)	600W
Peak power (W)	2,400W
Nominal Impedance	8Ω
Frequency Response	39 to 120Hz
Sensitivity 1W / 1 m	102dB
SPL max	135.8dB
Directivity	omnidirectional
Connectors	2x SPEAKON NL4
Dimensions (WxHxD)	465 x 505 x 740mm
Weight	32.7kg

CDR-01 CD/SD professional player, MP3/WMA/WAV

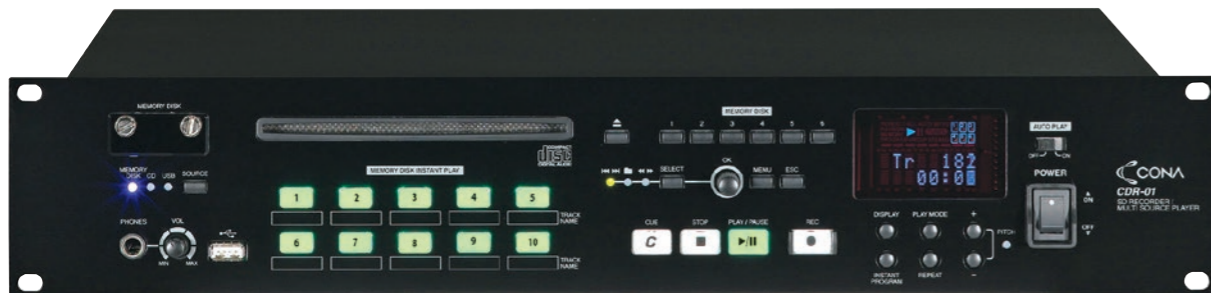

- It's a multi player that can store up to 6 audio CDs on one of the 6 virtual memories slots. The tracks of the CD virtually stored can be assigned to one of the 10 keys of reading thus allowing an instant playback.
- It offers a high quality recording and playback on CD, internal memory or SD CARD through high quality

digital-to-analog converters and stages of symmetrical outputs of Broadcast Quality.

- Events and conferences can be registered via the analog XLR input and easily shared.

Model	CDR-01
Discs and formats	CD / CD-R / CD-RW - MP3 / WMA / WAV
Number of channels	3 (left, right, mono)
Bandwidth (pitch off)	20Hz - 20kHz +0.5/-1dB
THD	< 0.003%
Signal / Noise	> 100dB
Max analog outputs level	XLR: +20dBu - RCA: +8dBu
Max analog inputs level	XLR: +20dBu - RCA: + 8dBu
Headphone output	20mW (32Ω)
Output connectors	RCA: L/R - XLR: L/R - MONO
Professional digital output	AES/EBU
Optical output	SPDIF
Coaxial output	SPDIF
Operating temperature	-10°C ~ 40°C
Consumption power	27W
Power source	230V - 50/60Hz
Dimensions (WxHxD)	482 x 88 x 280mm
Weight	5.3kg

CX 2310 2-band stereo active filter



- It's a professional quality active filter.
- It allows to distribute an input signal to adjustable frequency band. The signal can be separated into 2 bands on stereo mode and 3 bands on mono with subwoofer output.

- Its low noise electronic system and its precision potentiometers make it a high quality filter.

Model	CX 2310
Number of outputs	2 bands stereo / 3 bands mono
Input Output	balanced
Linkwitz-Riley Filter	24dB/octave
Level adjustment	on each band
Phase inverter	yes
Mute button	for each band
Low-cut filter	< 25Hz
Power source	240VAC - 50Hz
Consumption power	< 17W
Dimensions (WxHxD)	482 x 44 x 217mm
Weight	3kg



Rear panel



Rear panel

DEQ 2496
4 inputs - 8 outputs Audio processor



- Digital audio processor with a very high resolution 24Bit / 96kHz.
- This device has most used functions in the setting of professional broadcasting.
- Its high quality electronic delivers a pure sound without distortions or noise rendering.

- This device is recommended in facilities streaming amplified music with acoustically difficult environments like: ice rinks, stadiums...

Model	DEQ 2496
Inputs	2 x XLR balanced
Outputs	2 x XLR balanced
Mic input	1 x XLR balanced
Functions	Equalisation (graphic/ parametric) Compressor/ Expander Limiter Delay Feedback eliminator Display (RMS/ VU meter / SPL...) Real time FFT 31 bands Automatic correction location/speaker 64 memory locations
Converter A/N and N/A	24Bit - 96kHz
Dynamic	113dB
Power source	240VAC - 50Hz, 10W
Dimension (WxHxD)	482 x 44 x 217mm
Weight	3kg



Rear panel

ANTI LARSEN
Feedback eliminator



- 2-channel digital feedback eliminator with a 24 bit conversion.
- Automatically and intelligently locates and destroys up to 20 frequencies per channel.
- Ultra-fast feedback detection (> 0.2 sec) due to proprietary FFT signal analysis.

Model	ANTI LARSEN
Inputs	2 XLR symétriques / 2 jack symétriques
Outputs	2 XLR symétriques / 2 jack symétriques
Sampling	24 Bit - 96 kHz
Dynamic range	107 dB
T.H.D	0,007 %
Bandwidth	20 Hz - 20 kHz
Power source	240 V AC, 50 - 60 Hz, 10 W
Dimensions (WxHxD)	44,5 x 482,6 x 190,5 mm (1U)
Weight	1,9 kg



Rear panel

Acoustic limiter

M-LC-1A 1A SPL limiter

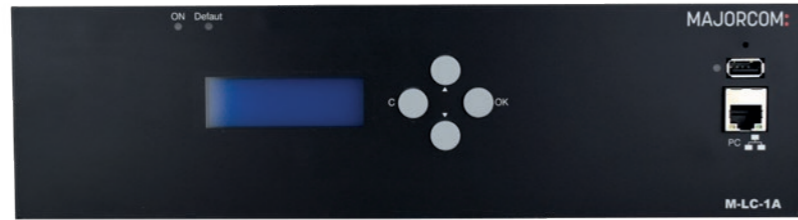

- The LC-1A reduces noise levels in a public place.
- It complies with NF S31-122-1-2017 on the prevention of risks related to amplified noise and sounds.
- All limiter settings are easily controlled via a web interface.

- Door/Window Opening Management, Fire Alarm Management and Beacon Activation (not included).
- Requires a SPL sensor to operate : M-GZ-CAPT1 (not included).

Model	M-LC-1A
Inputs / Outputs	2 dry contacts
Connections	1 plug-in connector, 2 screw terminals, 3 RJ45, 1 USB type A
Mounting	Wall-mounted 4 screws (or DIN rail / 19" rack : M-LC-1A-KIT-BAIE optional)
Power supply	230V or 48V
Dimensions (W x D x H)	340 x 82,3 x 50 mm
Weight	1,1 kg
Housing material	Sheet metal
Configuration	Via integrated display or web interface
Accessories included	30m Ethernet cable

Web interface

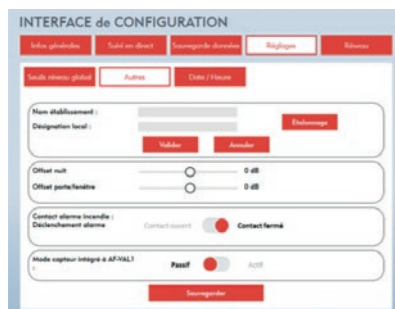

M-LC-1A-KIT-BAIE (optional)
M-LC-1A limiter 19" rack installation kit

Acoustic limiter

M-GZ-CAPT1 SPL sensor



- The GZ-CAPT1 is a stand-alone SPL sensor.
- It incorporates a digital sensor that measures sound level in dB.
- Its smoke-detector-style design enables it to be

- installed anywhere, very discreetly.
- A web interface (HMI) enables it to be parameterized, remotely controlled and, for example, visualized in real time.

Model	M-GZ-CAPT1
Display type	MEMS
Input / Output	RJ45 Ethernet
Connections	RJ45
Configuration	Via web interface (IHM)
Mounting	Wall/ceiling with 2 screws
Power supply	PoE (Power over Ethernet)
Dimensions (W x D x H)	Ø 110 x H 50 mm
Weight	0,135 kg
Housing material	ABS

Web interface

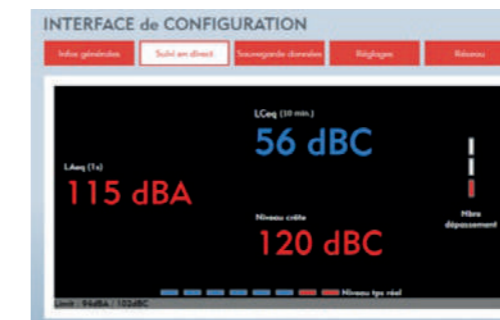

Acoustic limiter

M-AF-LED1
LED SPL display

- The M-AF-LED1 is a compact SPL display compatible with our M-LC-1A-PACK1 and M-LC-1A-PACK2 to limit the noise level in public places.
- It uses various LEDs to display the sound level

(normal / threshold / cut-off) and the number of electrical cuts made by the limiting system (maximum of 3 short cuts before a long cut).

Model	M-AF-LED1
Display type	LED sound level indicator
Information displayed	Number of interruptions (3 red LEDs) Sound level range (green LED = normal / yellow = threshold reached / red = exceeded)
Inputs	6 controls + 5V power supply
Connections	8-pin screw terminal block
Mounting	Wall-mounted using 4 screws
Power supply	5V DC
Dimensions (W x D x H)	160 x 90 x 50 mm
Weight	0,275 kg
Housing material	Shockproof ABS
Protection index	IP66

Acoustic limiter

M-AF-VAL1
LCD SPL display with integrated sensor

- The M-AF-VAL1 is a stand-alone SPL indicator.
- Its 12" LCD screen ensures good readability in any environment.
- It incorporates a digital sensor to measure the sound level directly without an external sensor.

- A web interface is also integrated, enabling the product to be remotely controlled, parameterized and the sound level to be visualized in real time on a computer.

Model	M-AF-VAL1
Display type	MEMS
Information displayed	Short LAeq, Long LAeq, LpcC, bargraph, 3 off LEDs
Inputs / Outputs	RJ45 Ethernet
Connections	RJ45, Power Jack
Mounting	Wall-mounted or base-mounted with 4 screws
Power supply	PoE (Power over Ethernet) or 24V DC
Dimensions (W x D x H)	332 x 161 x 40,5 mm
Weight	0,710 kg
Housing material	Polystyrene
Configuration	Via built-in display or web interface
Included accessories	30m Ethernet cable

Acoustic limiter

M-LC-1A-PACK1

1A SPL limiter system package (<300 person gauge)



- The M-LC-1A-PACK1 is a set of products to limit the noise level in a public place.
- It complies with NF S31-122-1-2017 on the prevention of risks related to amplified noise and sounds.
- This system is ideal for venues accommodating less than 300 people, where there is no obligation to display sound levels to the public.

- Its remote sensor is very discreet thanks to its smoke detector type design.
- All limiter settings are easily controlled via a web interface.
- Door/Window Opening Management, Fire Alarm Management and Beacon Activation (not included).

Web interface

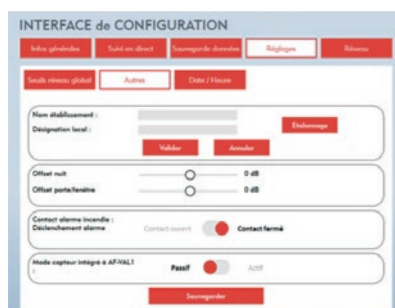

M-LC-1A-KIT-BAIE (optional)
M-LC-1A limiter 19" rack installation kit

Acoustic limiter

M-LC-1A-PACK2

1A SPL limiter system package (>300 person gauge)



- The M-LC-1A-PACK2 is a set of products to limit the noise level in a public place.
- It complies with NF S31-122-1-2017 on the prevention of risks related to amplified noise and sounds.
- This system is ideal for venues accommodating more than 300 people and being normatively in the obligation to display the noise level.
- Its remote LCD display measures and indicates regulatory sound levels and also incorporates a measurement sensor.
- Its 12" LCD screen ensures good readability in any environment.
- All limiter settings are easily controlled via a web interface.

- Door/Window Opening Management, Fire Alarm Management and Beacon Activation (not included).



M-LC-1A-KIT-BAIE (optional)
M-LC-1A limiter 19" rack installation kit

WHAT DOES FRENCH LAW SAY ?

Limiting noise levels aims to protect the public's hearing and the peace and quiet of local residents.

It is defined by Article R1336-6 of the Public Health Code, since updated by Decree 2017-1244 of August 7, 2017.

It applies to « all premises and establishments receiving the public and broadcasting amplified music on a regular basis ».

In concrete terms, this legislation concerns discotheques, bars, dance restaurants, hotels, karaoke

bars, concert halls, party halls, reception halls for weddings and birthdays, etc.... In addition, the new law also extends to outdoor shows and festivals.

To apply this limitation of decibels, defined in advance by a noise impact study, the law introduces an **obligation to display and record sound levels**. It only applies to establishments with a capacity of **at least 300 people and to discotheques**, the **M-LC-1A-PACK2** meets this standard.

Class-D power Amplifiers with DANTE™ network & DSP

DSA-500Q: 300W / 8Ω - 500W/4Ω - 1000W/8Ω bridged amp with DANTE™ network and DSP incorporated

DSA-2000Q: 1200W / 8Ω - 2000W/4Ω - 4000W/8Ω bridged amp with DANTE™ network and DSP incorporated



You can easily configure the DSA-500Q and DSA-2000Q and DSP remotely via PC

- DSA-500Q & DSA-2000Q are 4-CH high power and high quality professional amplifiers which incorporate a DSP, Digital Signal Processor and Audinate's Dante™ digital audio network.
- DANTE™ delivers low latency, robust synchronization, I/O scalability, and installation simplicity via standard IT technology.
- Easy control of equipment through front panel with OLED and PC GUI.
- Simultaneous control of multiple amplifiers via PC GUI.
- Up to 340ms delay time adjustable.
- Unlimited preset creation for environment-optimization.

Model	DSA-500Q	DSA-2000Q	
Rated Power -20ms burst (Static)	8Ω, Stereo Mode	300W	1200W
	4Ω, Stereo Mode	500W	2,000W (900W)
	2Ω, Stereo Mode	800W (400W)	2,000W (450W)
	8Ω, Mono Mode Bridged	1,000W	4,000W (1800W)
	4Ω, Mono Mode Bridged	1,600W (800W)	4,000W (900W)
Input Sensitivity	+4dBu		+10dBu
Gain (Stereo, Mono)	32dB		
Gain (Bridged)	38dB		
S/N	> 92dB		
THD (1/3W Rated power)	< 0.5%		< 0.7%
Bandwidth (1W, 0±2dB / 8Ω)	20Hz to 20,000Hz		
DSP Precision	32bit Fixed Point(8.24 format)		
A/D, D/A	24bit conversion, sampling rate: 48kHz		
DSP Function	Input gain, Parametric EQ, HPF, LPF, Limiter, Delay		
Consumption	390W (1/8 rated power @ 2Ω)	700W (1/8 rated power @ 2Ω)	
Power source	AC 220-240V, 50/60Hz		
Operating Temperature/Humidity	-10°C~+40°C/ 0%-90%		
Dimensions (WxHxD)	482 x 88 x 420mm		
Weight	10.48kg	11.79kg	

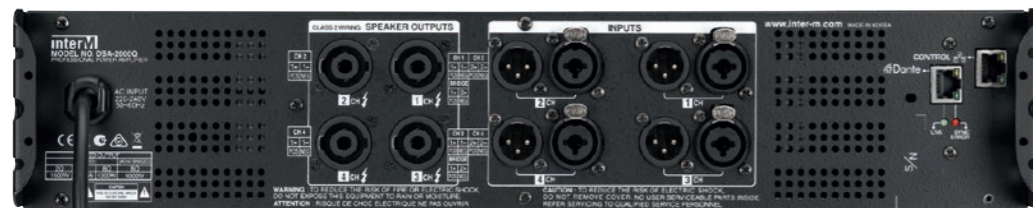

Rear panel



FICHE SPEAKON NL4

Input and link by 4-pole male SPEAKON plug (optional)

2-channel low impedance amps

L-1800: 2 x 360W - 8Ω / 2 x 600W - 4Ω amplifier

L-2400: 2 x 500W - 8Ω / 2 x 750W - 4Ω amplifier



L-1800

• High quality low impedance amplifier which can deliver a power of 2x 650W under 4Ω and can be bridged to obtain 1800W under 4Ω.

L-2400

• High quality low impedance amplifier which can deliver a power of 2x 750W under 4Ω and can be bridged to obtain 2400W under 4Ω.

They are equipped with:

- a protective circuit against overloads and short circuits
- a high-pass active filter to protect speakers from very low frequencies < 50Hz or < 30Hz to be selected
- an input limiter that can be activated with a switch
- a display of modulation by LED (protection, saturation, modulations).

Model	L-1800	L-2400
Power	2 x 360W RMS under 8Ω 2 x 600W RMS under 4Ω 1,200W RMS bridged under 8Ω 1,800W RMS bridged under 4Ω	2 x 500W RMS under 8Ω 2 x 750W RMS under 4Ω 1,500W RMS bridged under 8Ω 2,400W RMS bridged under 4Ω
Bandwidth	20Hz - 20kHz ±1dB 5Hz - 70kHz ±3dB	
T.H.D	< 0.03%	
Channel separation	> 80dB	
Residual noise	< -85dB	
Signal / Noise	> 100dB	
Input sensitivity	3,5dBu	
Output circuit	Class-H	
Protection	Thermal, short circuit	
Power source	220V - 4A	220V - 4,5A - 50Hz
Dimensions (WxHxD)	482 x 88 x 369mm	
Weight	15kg	



Rear panel



FICHE SPEAKON NL4

Input and link by 4-pole male SPEAKON plug (optional)

Notes

Notes

Our systems strictly comply with the requirements of European EN 54 and international ISO standards. These certifications, genuine proof of quality and reliability, give you total peace of mind while ultimately guaranteeing the safety of the public concerned.



The EC marking of our products guarantees compliance with the European regulation in terms of safety, health and environmental protection while ensuring their free circulation within the European Union.



Stands for "Restriction of the use of certain Hazardous Substances in electrical and electronic equipment". Our products respect the RoHS European directive (2002/95/EC), the purpose of which is to limit the use of certain heavy metals and other harmful materials.



Our **EN-54** products comply with European safety requirements in terms of fire detection and alarm systems.



EN 54-16 concerns the voice alarm control and indicating equipment.



EN 54-24 concerns the components of voice alarm systems (Loudspeakers).

EN 54-4 concerns the power supply equipment.



Our **ISO 7240** products comply with International safety requirements in terms of fire detection and alarm systems.

ISO 7240-24 concerns the components of voice alarm systems (Loudspeakers).



DANTE is the newest networking standard for audio developed by Audinate. It respects the standard Ethernet standard and is compatible with the future standard AVB. Advantage: high number of channels and multi-format, low latency, native redundancy, automatic network configuration, use of standard Ethernet hardware.



Establishments receiving services from the public shall be such as to enable persons with disabilities to access, circulate and receive information disseminated therein in the areas open to the public. In this context, the installation of a magnetic induction loop amplifier for the hearing impaired Check-out counters, meeting rooms, conference rooms, shows..., is imperative. This does not apply only to E.R.P. but also to the liberal professions and traders.

MAJORCOM is ISO 9001 certified

The ISO 9001:2015 certification of the quality management system demonstrates MAJORCOM's commitment to delivering a quality service and satisfying its customers while constantly improving its quality management systems. The award of an ISO 9001:2008 certificate by a prestigious company like BUREAU VERITAS is proof of high quality and also demonstrates that MAJORCOM complies with the quality management principles recognised at the highest international level.



MAJORCOM:

Custom-designed sound systems by a
**highly involved Design Office, R&D,
Customer Service and Support Functions.**

www.majorcom.fr



PRODUCTS



SOLUTIONS



SERVICES



SUPPORT

56, chemin de la Flambère - 31300 Toulouse - France
Tel. +33 5 61 31 86 87 • Fax +33 5 61 31 87 73 • commercial@majorcom.fr