

User Manual



ULTRACURVE PRO DEQ2496

Ultra-High Precision 24-Bit/96 kHz Equalizer, Analyzer, Feedback Destroyer and Mastering Processor



Table of Contents

Important Safety Instructions	3
Legal Disclaimer	3
Limited warranty	3
1. Introduction	5
1.1 Before you get started	5
1.2 About this manual.....	5
2. Control Elements	5
2.1 Front panel.....	5
2.2 Rear panel	6
3. Menu Structure and Editing	6
3.1 General operation and display structures	6
3.2 Equalizer modules.....	6
3.3 WIDTH menu.....	9
3.4 DYN menu	10
3.5 UTILITY menu.....	11
3.6 I/O menu	12
3.7 BYPASS menu.....	13
3.8 RTA menu (Real-Time Analyzer)	13
3.9 MEMORY menu	14
3.10 METER menu	15
3.11 RTA/MIC input.....	15
4. Applications	15
4.1 Sum-signal equalizer for live applications.....	15
4.2 Equalizer in the monitor path	17
4.3 Using the ULTRACURVE PRO in the studio.....	17
4.4 Using the ULTRACURVE PRO as a delay unit.....	17
5. Connections	18
5.1 MIDI connections.....	18
5.2 Analog connections	18
5.3 Digital connections (AES/EBU and S/PDIF)	18
5.4 WORDCLOCK connection.....	19
6. Operating Software.....	19
7. Specifications	19
7.1 MIDI implementation	21

EN Important Safety Instructions



Terminals marked with this symbol carry electrical current of sufficient magnitude to constitute risk of electric shock.

Use only high-quality professional speaker cables with ¼" TS or twist-locking plugs pre-installed. All other installation or modification should be performed only by qualified personnel.



This symbol, wherever it appears, alerts you to the presence of uninsulated dangerous voltage inside the enclosure - voltage that may be sufficient to constitute a risk of shock.



This symbol, wherever it appears, alerts you to important operating and maintenance instructions in the accompanying literature. Please read the manual.



Caution

To reduce the risk of electric shock, do not remove the top cover (or the rear section). No user serviceable parts inside. Refer servicing to qualified personnel.



Caution

To reduce the risk of fire or electric shock, do not expose this appliance to rain and moisture. The apparatus shall not be exposed to dripping or splashing liquids and no objects filled with liquids, such as vases, shall be placed on the apparatus.



Caution

These service instructions are for use by qualified service personnel only. To reduce the risk of electric shock do not perform any servicing other than that contained in the operation instructions. Repairs have to be performed by qualified service personnel.

1. Read these instructions.
2. Keep these instructions.
3. Heed all warnings.
4. Follow all instructions.
5. Do not use this apparatus near water.
6. Clean only with dry cloth.
7. Do not block any ventilation openings. Install in accordance with the manufacturer's instructions.
8. Do not install near any heat sources such as radiators, heat registers, stoves, or other apparatus (including amplifiers) that produce heat.

9. Do not defeat the safety purpose of the polarized or grounding-type plug. A polarized plug has two blades with one wider than the other. A grounding-type plug has two blades and a third grounding prong. The wide blade or the third prong are provided for your safety. If the provided plug does not fit into your outlet, consult an electrician for replacement of the obsolete outlet.

10. Protect the power cord from being walked on or pinched particularly at plugs, convenience receptacles, and the point where they exit from the apparatus.

11. Use only attachments/accessories specified by the manufacturer.



12. Use only with the cart, stand, tripod, bracket, or table specified by the manufacturer, or sold with the apparatus. When a cart is used, use caution when moving the cart/apparatus combination to avoid

injury from tip-over.

13. Unplug this apparatus during lightning storms or when unused for long periods of time.

14. Refer all servicing to qualified service personnel. Servicing is required when the apparatus has been damaged in any way, such as power supply cord or plug is damaged, liquid has been spilled or objects have fallen into the apparatus, the apparatus has been exposed to rain or moisture, does not operate normally, or has been dropped.

15. The apparatus shall be connected to a MAINS socket outlet with a protective earthing connection.

16. Where the MAINS plug or an appliance coupler is used as the disconnect device, the disconnect device shall remain readily operable.



TO BIND MUSIC GROUP BY ANY EXPRESS OR IMPLIED UNDERTAKING OR REPRESENTATION. THIS MANUAL IS COPYRIGHTED. NO PART OF THIS MANUAL MAY BE REPRODUCED OR TRANSMITTED IN ANY FORM OR BY ANY MEANS, ELECTRONIC OR MECHANICAL, INCLUDING PHOTOCOPYING AND RECORDING OF ANY KIND, FOR ANY PURPOSE, WITHOUT THE EXPRESS WRITTEN PERMISSION OF MUSIC GROUP IP LTD.

ALL RIGHTS RESERVED.

© 2013 MUSIC Group IP Ltd.

Trident Chambers, Wickhams Cay, P.O. Box 146, Road Town, Tortola, British Virgin Islands

LIMITED WARRANTY

For the applicable warranty terms and conditions and additional information regarding MUSIC Group's Limited Warranty, please see complete details online at www.music-group.com/warranty.

LEGAL DISCLAIMER

TECHNICAL SPECIFICATIONS AND APPEARANCES ARE SUBJECT TO CHANGE WITHOUT NOTICE AND ACCURACY IS NOT GUARANTEED. BEHRINGER, KLARK TEKNIK, MIDAS, BUGERA, AND TURBOSOUND ARE PART OF THE MUSIC GROUP (MUSIC-GROUP.COM). ALL TRADEMARKS ARE THE PROPERTY OF THEIR RESPECTIVE OWNERS. MUSIC GROUP ACCEPTS NO LIABILITY FOR ANY LOSS WHICH MAY BE SUFFERED BY ANY PERSON WHO RELIES EITHER WHOLLY OR IN PART UPON ANY DESCRIPTION, PHOTOGRAPH OR STATEMENT CONTAINED HEREIN. COLORS AND SPECIFICATIONS MAY VARY FROM ACTUAL PRODUCT. MUSIC GROUP PRODUCTS ARE SOLD THROUGH AUTHORIZED FULLFILLERS AND RESELLERS ONLY. FULLFILLERS AND RESELLERS ARE NOT AGENTS OF MUSIC GROUP AND HAVE ABSOLUTELY NO AUTHORITY

1. Introduction

Thank you very much for expressing your confidence in BEHRINGER products by purchasing the ULTRACURVE PRO DEQ2496, an extremely high-quality DSP-based digital audio processor with built-in 24-bit/96 kHz A/D and D/A converters, making it an ideal tool for both live and studio applications.

The ULTRACURVE PRO gives you a variety of EQs (graphic, parametric and dynamic) plus a real-time analyzer with Auto EQ function, dynamics processors such as compressor, expander and peak limiter and a complete set of analog and digital interface options.

With these and many more features the DEQ2496 is an absolutely all-purpose device for your recording or mastering studio and will definitely upgrade your live equipment.

♦ This manual first describes the terminology used, so that you can fully understand the DEQ2496 and its functions. Please read the manual carefully and keep it for future reference.

1.1 Before you get started

1.1.1 Shipment

The ULTRACURVE PRO was carefully packed at the factory and the packaging is designed to protect the unit from rough handling. Nevertheless, we recommend that you carefully examine the packaging and its contents for any signs of physical damage which may have occurred during transit.

♦ If the unit is damaged, please do NOT return it to BEHRINGER, but notify your dealer and the shipping company immediately. Otherwise claims for damage or replacement may not be granted.

1.1.2 Initial operation

Be sure that there is enough space around the unit for cooling and, to avoid overheating, do not place the DEQ2496 on top of power amps or near radiators, etc.

♦ Blown fuses must be replaced by fuses of the same type and rating. Please refer to the "Specifications" for further details.

The mains connection is made using the enclosed power cord and a standard IEC receptacle. It meets all of the international safety certification requirements.

♦ Please make sure that all units have a proper ground connection. For your own safety, never remove or disable the ground conductor from the unit or the AC power cord.

1.1.3 Warranty

The DEQ2496's serial number is located on its top cover. Please take the time to fill in and return the warranty card within 14 days after the date of purchase, so as to benefit from our extended warranty. Or register online at behringer.com.

1.2 About this manual

This manual has been designed so that you can get a clear overview of all control elements and at the same time find detailed information on how to use them. If you need more information on specific topics, please visit our web site at behringer.com, where we explain effects processing and power amp applications.

2. Control Elements

2.1 Front panel

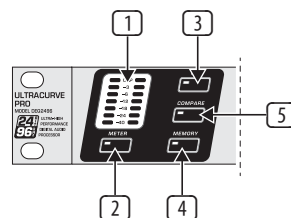

Fig. 2.1: LED meter and menu keys

- 1 The LED **METER** indicates the DEQ2496's input signal. The top CLIP LED lights up as soon as the input signal level is too high or the peak limiter in the Dynamics menu (see chapter 3.4) has been activated.
- 2 Use the **METER** key to select the METER menu (see chapter 3.10).
- 3 The DEQ2496 features a built-in real-time analyzer displaying the entire frequency range. Use the **RTA** key to select the corresponding menu and adjust the various settings (see chapter 3.8).
- 4 Depending on the currently selected menu, the **COMPARE** key allows you to compare either complete presets or individual modules. The following table shows how the COMPARE key works in each module:

	COMPARE (complete preset)	COMPARE (module only)
GEQ		X
PEQ		X
DEQ		X
FBD	X	
WIDTH		X
DYN		X
UTIL	X	
I/O		X
BYPASS	X	
RTA		not active
MEMORY	X	
METER		not active

Tab. 2.1: COMPARE function for individual ULTRACURVE PRO modules

- 5 Press the **MEMORY** key to select the MEMORY menu (see chapter 3.9). Here, you can save or recall complete presets or individual modules from one preset (e.g. GEQ, PEQ etc.). The MEMORY LED lights up as soon as the parameter values of the preset selected in the MEMORY menu differ from currently active settings.

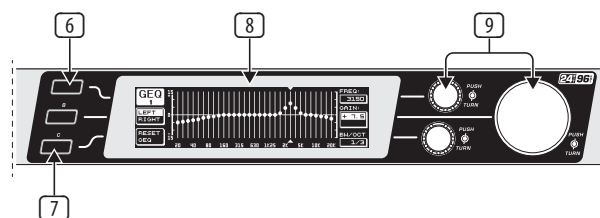

Fig. 2.2: Keys, display and rotary controls

- 6 The **PAGE** key allows you to select the various pages within one menu.
- 7 The functions performed by the keys **A** and **B** depend on the selected menu and are indicated in the display.
- 8 This is the **LC** display of your ULTRACURVE PRO.

- 9 The DEQ2496 has three **DATA WHEELS**, which can be used to select and edit various parameters—again depending on the currently selected menu. Often, they perform a dual function, i.e. you can edit by turning and pressing a data wheel. Pressing the data wheels also changes the scaling of many parameters (step width) or confirms/resets previously made entries.

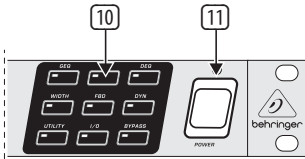

Fig. 2.3: The menu keys of the DEQ2496

- 10 With the menu keys you can select the individual menus of the various modules. They can also be used to select specific pages from these menus (like PAGE key). Each of these keys has a built-in LED, which lights up when the corresponding module starts modifying the sound. When the DEQ2496 receives MIDI data, the LED of the UTILITY key lights up briefly. Keep this key pressed for about 1 s to bypass active modules or re-activate disabled ones. This function refers only to those modules which can be edited in the BYPASS menu (see chapter 3.7).
- 11 Use the **POWER** switch to put the DEQ2496 into operation. This switch should be set to “Off” before you connect the unit to the mains.

2.2 Rear panel

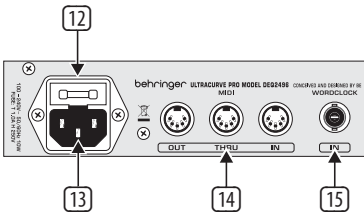

Fig. 2.4: Mains, MIDI and wordclock connectors

- 12 The **FUSE HOLDER** holds the mains fuse of the DEQ2496. Blown fuses must be replaced by fuses of the same type and rating. Please see the “Specifications” for further details.
- 13 The mains connection is made using the enclosed power cord and a standard **IEC** receptacle.
- 14 The MIDI jacks enable the DEQ2496 to communicate with a computer or other MIDI equipment. Incoming MIDI data are received on the **MIDI IN**, outgoing MIDI data are sent via the **MIDI OUT**. Received MIDI data are also present at the **MIDI THRU** jack, so as to pass them on unmodified to other devices.
- 15 Use the **WORDCLOCK** input to synchronize your DEQ2496 to external equipment via a wordclock signal. This connector is on a BNC coaxial jack.

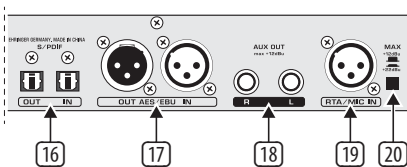

Fig. 2.5: Digital interfaces and RTA microphone input

- 16 Your DEQ2496 features a digital optical interface for the transmission/reception of data in both AES/EBU and S/PDIF formats.
- 17 The digital **AES/EBU** interface (XLR connectors) also sends/receives AES/EBU or S/PDIF signals.

- 18 The **AUX OUT** phone jack is an additional stereo output, which allows you to tap the audio signal present at the digital outputs in analog form.
- 19 The **RTA/MIC IN** XLR connector can be used to connect a measurement microphone providing an input signal for the real-time analyzer or SPL meter. This connector has a switchable +15 V phantom power supply for condenser microphones and can be set to microphone or line sensitivity (see chapter 3.11).
- 20 The **MAX** switch raises the maximum level present at the MAIN inputs/outputs from +12 dBu to +22 dBu.

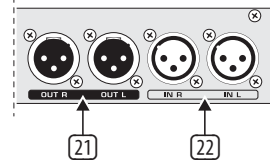

Fig. 2.6: Input and output connectors

- 21 These balanced XLR connectors provide the analog output signal of the DEQ2496.
- 22 These balanced XLR inputs are used to connect analog input signals.

3. Menu Structure and Editing

This chapter provides you with detailed information on how to use the various functions on each menu page. We recommend that you keep this user's manual available while working with the DEQ2496, so as to use it as a reference in case of any problems.

3.1 General operation and display structures

When you select a menu with the GEQ, PEQ, DYN, etc. keys, the display indicates the respective menu structure. To the left and right along the display you will find functions and parameters for preset editing, which are assigned to the A and B keys (left) and the three data wheels (right) and can be used for editing as required.

Most of the menus comprise several pages. The actual number of pages is shown in the top left part of the display, below the menu name. Use the corresponding menu key or the PAGE key to the left of the display to switch from one page to the next and back again.

As the functions performed by the A and B keys and the data wheels depend on the currently selected menu, all operating steps are described in full detail below. All menus are dealt with one after the other, and all functions and parameters are explained explicitly.

◆ Please note that the left and right channels will be edited simultaneously in STEREO LINK mode.

3.2 Equalizer modules

3.2.1 GEQ menu

Press the GEQ key to enter the GEQ menu. This menu has just one page and allows you to set all filters as desired.

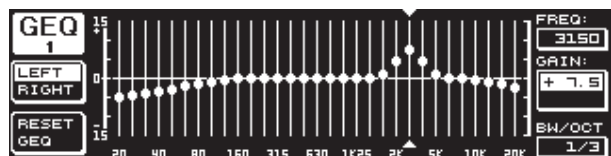

Fig. 3.1: GEQ menu

Turn the upper data wheel to select a frequency band for editing with the **FREQ** parameter. 31 bands are available comprising the entire frequency spectrum from 20 Hz to 20 kHz. With the large data wheel (**GAIN**) you can boost or cut the level of the selected band. The setting range is from -15 to +15 dB.

VPQ (Virtual Paragraphic Equalizer) function

The lower data wheel (**BW/OCT**) additionally assigns the required bandwidth to the filters. This means that the frequency bands have a peaking boost/cut characteristic around their center frequency. The number of adjacent frequency ranges influenced by this is determined by the bandwidth. The setting range is from 1/3 to 59/3.

As soon as this parameter has been modified, the RESET GEQ message (left bottom part of display) changes to ACCEPT VALUES. Now, when you press the B key (or the large data wheel), the current value is stored and you can continue to enter the filter settings as required.

When you press the lower data wheel, the BW/OCT parameter changes to **MODE**. Turn the wheel to select a HIGH or LOW shelving filter. In this case, the GAIN parameter changes to dB/OCT. Use the large data wheel to adjust the filter slope from -15 to +15 dB/oct. In HIGH mode, all frequency bands above the selected frequency are now raised or lowered in level. In LOW mode, all frequency bands below that frequency are modified. Confirm your entries with the B key (ACCEPT VALUES).

The A key to the left of the display can be used in DUAL MONO mode to alternate between the left and right-channel audio signal. Keep the key pressed for some time to display the settings of both sides and edit them simultaneously. In STEREO LINK mode both channels are always processed simultaneously.

The B key allows you to reset the filter settings (RESET EQ). Hit it briefly to reset the currently selected frequency band to 0.0 dB gain. Press it for about 1 s to reset all frequency bands. Single frequency bands can be reset by pressing the large data wheel.

3.2.2 PEQ menu

Press the **PEQ** key to use parametric EQs for signal processing. On each stereo side, you have ten EQs available, which can be set to PEQ or FBD mode (Feedback Destroyer: see chapter 3.2.4). In addition to the band-pass filters, this menu offers filters of the shelving type (high or low), with a slope of 6 or 12 dB/oct.

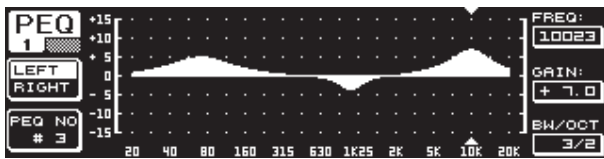

Fig. 3.2: PEQ menu (page 1)

This menu comprises two pages, as can be seen in the top left part of the display. Similar to the GEQ menu, page 1 of the PEQ menu provides a graphic representation of the entire frequency range. Parameter changes can be effected with the corresponding controls (FREQ: upper data wheel, GAIN: large data wheel, BW/OCT: lower data wheel).

To reset the selected PEQ, keep the B key to the left of the display pressed for about 1 s. Or hit it briefly to select the parametric filters.

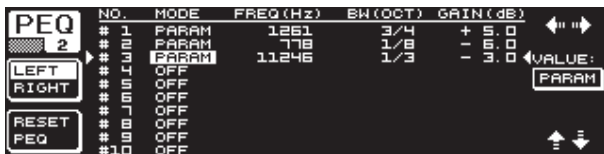

Fig. 3.3: PEQ menu (page 2)

Press the PAGE or PEQ key to select the second menu page. If no parametric EQ was selected before, page 2 will be displayed immediately, providing a list of the ten available locations with all relevant parameters. Single filters can be selected either by turning the lower data wheel or by pressing the lower and upper data wheels (UP/DOWN). **MODE** allows you to activate the selected filter with the large data wheel (press or turn) (PARAM). This will display the associated parameters **FREQ**, **BW(OCT)** and **GAIN**, which can be selected by turning the upper data wheel. Value changes must be entered with the large data wheel. The GAIN setting range is from -15 to +15 dB, the frequency range (FREQ) is from 20 to 20,000 Hz. The FREQ parameter can be adjusted with two scales. The first scrolls faster through the frequency ranges (1/6 oct. per step), the second uses much finer increments (1/60 oct. per step). Press the large data wheel to alternate between these two scales.

The parameter BW(OCT) adjusts the bandwidth of the band-pass filter. The “width” of the peaking characteristic (1/10 oct. to 10 oct.) is determined by this value. Additionally, you can select shelving filters here with a slope of 6 or 12 dB/oct. (e.g. L=Low, 6 dB / H=High, 12 dB, etc.)

Explanation:

The low-shelving filter raises (positive gain) or lowers (negative gain) the level of the frequency band below the adjusted frequency.

The high-shelving filter, on the other hand, raises (positive gain) or lowers (negative gain) the level of the frequency band above the adjusted frequency.

The band-pass filter raises or lowers the level of the frequency range around the center frequency.

The GAIN and BW(OCT) values can be reset by pressing the large data wheel.

In this menu too, the A keys select the left and right-channel signals. If STEREO LINK mode has been selected in the UTILITIES menu (chapter 3.5), the parameter values refer to both sides.

♦ At least one filter must be activated on page 2 to be able to recall the first page of the PEQ menu.

3.2.3 DEQ menu

Press the **DEQ** key to select the DEQ menu. Due to their complexity, the Dynamic EQs have their parameters split up on three pages.

Explanation:

A Dynamic EQ influences a defined frequency range of a signal, based on the volume level. It can either raise or lower the level of a specific frequency, depending on the GAIN setting chosen by the user.

When the GAIN setting selected causes the frequency range to be lowered in level, and when the signal exceeds a pre-defined THRESHOLD, the EQ starts processing the sound and cuts the level of the respective frequency range. The amount of attenuation applied is determined by the RATIO parameter. When the signal drops below the THRESHOLD, the frequency range is “smoothed out” again, i.e. the Dynamic EQ stops processing the frequency range.

When the GAIN setting selected causes the frequency range to be raised in level, this boost depends on the volume level. As soon as the level of the selected frequency range drops below a pre-defined THRESHOLD, this results in a signal boost determined by the RATIO parameter. If the signal exceeds the threshold again, the Dynamic EQ stops processing the sound.

On pages 1 and 2 of the DEQ menu you can adjust the necessary settings to determine the threshold and the way of sound processing. Additionally, you will find a graphic representation of the control curve with regard to THRESHOLD, GAIN and RATIO. In the center of the display, the LEVEL meter (left) indicates the filtered DEQ input level (control signal), while the GAIN meter (right) shows how much boost/cut is applied to the signal.

Page 3 includes a frequency diagram showing the filter curves with regard to frequency and threshold. The current DEQ input level can be seen from the LEVEL meter on the right.

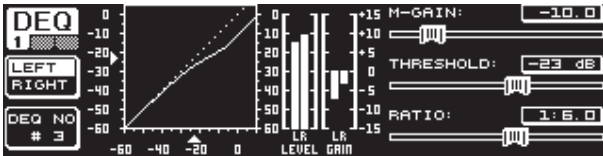

Fig. 3.4: DEQ menu (page 1)

The make-up gain parameter **M-GAIN** on page 1 allows you to set the amount of boost/cut for the filter with the upper data wheel. The setting range is from -15 to +15 dB. **THRESHOLD** (large data wheel) defines the threshold as of which the filter function is activated. If the filter has been set to attenuate the signal (M-GAIN < 0), then the desired frequency range (see page 3) will be lowered in level as soon as it exceeds the threshold. If boost is required (M-GAIN > 0), the frequency range will be raised in level as soon as the signal drops below the threshold. The **RATIO** parameter (lower data wheel) determines the amount of boost/cut applied to the respective frequency range, if the signal exceeds or drops below the threshold. The setting range is from 1:2 to 1:100.

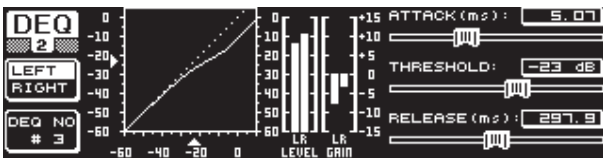

Fig. 3.5: DEQ menu (page 2)

On the second page of the DEQ menu (accessed by pressing the DEQ or PAGE key), you can define two additional dynamics parameters.

ATTACK (upper data wheel) determines how fast the dynamic EQ starts processing when the signal exceeds or drops below the threshold. The ATTACK times available range from 0 to 200 milliseconds. Press this control to select a coarse or fine adjustment scale.

The **RELEASE** parameter (lower data wheel) lets you adjust the time needed by the EQ to “release” the sound after the signal has exceeded or dropped below threshold (depending on the GAIN setting). The RELEASE times available range from 20 to 4,000 milliseconds. Here, too, you can press the control to select a coarse or fine adjustment scale.

It is on this page that you can also edit the **THRESHOLD** value (large data wheel), so as to be able to make some readjustments without having to change to another page.

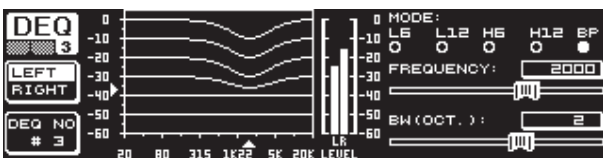

Fig. 3.6: DEQ menu (page 3)

As mentioned before, page 3 includes a frequency diagram and the gain reduction meter. **MODE** (upper data wheel) defines the filter type, and you can choose from high-shelving, low-shelving and band-pass filters.

The **FREQUENCY** parameter determines the center frequency of the filter (large data wheel). In the case of low-shelving and high-shelving filters, this is the cut-off frequency as of which the low or high frequencies are processed. The entire frequency spectrum ranges from 20 to 20,000 Hz. Press the data wheel to select a coarse (1/6 oct. per step) or fine adjustment scale (1/60 oct. per step).

If you selected “bandpass” under MODE, the parameter **BW(OCT)** appears in the lower right part of the display. Here, you can use the lower data wheel to adjust the bandwidth of your choice and thus determine the “width” of the filter curve (1/10 oct. to 10 oct.).

The B key selects which of the dynamic EQs is displayed. Three EQs are available for each stereo side. Keep the key pressed to reset the settings of the currently selected DEQ.

This table shows an example with extreme settings, thus illustrating how a dynamic EQ works:

Settings	
MODE	BP
FREQ	1.00 kHz
M-GAIN	+15 dB > continuous line 0 dB > broken line -15 dB > dotted line
BW(OCT)	0.1
THRESHOLD	-40 dB
RATIO	1:100

Tab. 3.1: Bandpass with extreme settings (see also fig. 3.7)

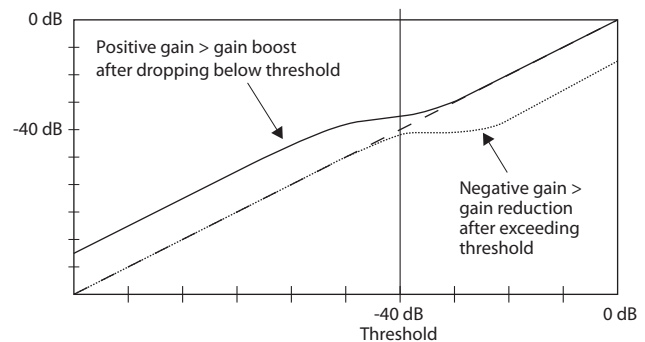

Fig. 3.7: Filter curves with signal above/below the threshold

3.2.4 FBD menu

The DEQ2496 features a “Feedback Destroyer” function, which corresponds largely to the PEQ menu as far as operation and choice of parameters are concerned. However, the FBD menu has some additional functions and therefore comprises three pages rather than just two.

The Feedback Destroyer allows you to apply heavy attenuation (no boost) to specific frequency ranges, so as to remove certain frequencies that are liable to cause feedback. With its extremely narrow-band filters it hardly affects the overall sound at all.



Fig. 3.8: FBD menu (page 1)

The first page shows a graphic representation of the filters. It is structured and operated in the same way as the first page in the PEQ menu. Since this menu can only be used to cut signals, the 0 dB line is located in the upper part of the display. The differences here are the settings ranges for the GAIN and BW(OCT) parameters. In order to achieve extremely narrow-band filters with high attenuation factors, the bandwidth ranges from 1/10 to 1/60 oct. and the GAIN from 0 to -60 dB.

◆ **At least one filter must be activated on page 2 to be able to access the first page of the FBD menu.**

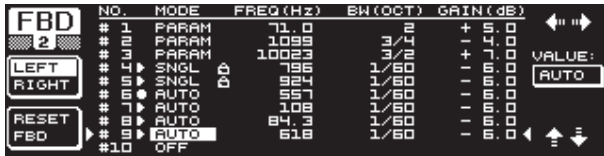

Fig. 3.9: FBD menu (page 2)

Page 2 provides a table showing the ten memory locations available. If parametric EQs have been activated in the PEQ menu, these will be shown here too, because the memory locations are intended for both FBD and PEQ settings.

◆ **Any parametric EQs activated in the PEQ module cannot be edited in the Feedback Destroyer menu (FBD)—and vice versa.**

In general, you can select two types of feedback filters: SNGL mode (single shot) and AUTO mode. To be able to identify feedback frequencies, the Feedback Destroyer splits up the entire frequency spectrum (20 Hz to 20 kHz) into bands of 1/60 octave and measures their respective levels. The resulting values are then referenced to the level of the complete signal. The difference between these levels determines whether a filter is activated or not. As soon as a filter is set to AUTO or SNGL mode, the unit automatically tracks feedback frequencies and assigns the active filters to them.

AUTO mode

Microphones that are moved around during a performance (e.g. vocal mics) often suffer from varying feedback frequencies as a result of the changing positions on stage. This kind of feedback is best suppressed in AUTO mode. A filter in AUTO mode automatically identifies the optimum parameter settings for feedback suppression. If the feedback frequencies change, the AUTO filter can track them and keep suppressing them. It always selects the respective frequencies and a very narrow-band filter configuration to affect the wanted signal as little as possible. When all filters are locked in to a specific frequency, and a “new” feedback frequency occurs, then the filter with the “oldest” or first feedback frequency detected is released and used for the new one. If new feedback occurs very close to or even at an already identified frequency, the parameters of the filter already in use will be adapted, for example by widening its bandwidth or raising the amount of signal attenuation.

SNGL mode

Filters in SNGL mode (single shot) also searches feedbacks automatically. If feedback is identified, the filter parameters are configured optimally for feedback suppression. Contrary to filters in AUTO mode, filters in SNGL mode lock in firmly to the identified frequency (LOCK FBD), however, their width and depth are still being adapted to changes in the feedback frequencies. The bandwidth is enlarged, if the feedback frequency shifts slightly, and the amount of attenuation is raised if feedback persists. To prevent a feedback frequency from recurring, the amount of attenuation is not reduced. Thus, SNGL mode is ideally suited to suppress constant feedback frequencies, as they are typically produced by fixed or permanently installed microphones.

Use the **LOCK FBD** function (B key in the left bottom part of the display) to lock the frequency of the SNGL filter manually (SNGL ). This means that the filter can only be modified in its bandwidth and amount of attenuation. With UNLOCK FBD (B key) it can be unlocked again.

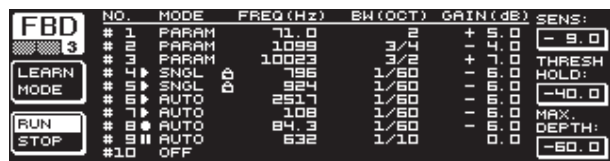

Fig. 3.10: FBD menu (page 3)

The third page provides three additional dynamics parameters for all FBD filters.

SENS (upper data wheel) allows you to determine the point of onset for feedback suppression (describes the difference between feedback signal and overall level). When a signal reaches this difference, it gets reduced in level. The setting range here is from -3.0 to -9.0 dB. Use **THRESHOLD** (large data wheel) to select the threshold from which a certain frequency is considered to be feedback. The **MAX. DEPTH** parameter below determines the maximum attenuation of a filter (-18 to -60 dB) in 6 dB steps, and thus the GAIN setting range as displayed on the first and second page (lower data wheel).

LEARN MODE is activated with the A key. This function generates additional short pulses and raises the overall gain to provoke feedback. Subsequently, the feedback signals arrive at the input of the DEQ2496, are identified and suppressed. LEARN MODE is ideal for use before a live event, for example to automatically configure the SNGL filters (“tuning-in” of a P.A. system).

The following symbols inform you about the current status of the filters:

- In this setting, an AUTO or SNGL filter is “on duty” (RUN) to react to the incoming signal and effect the necessary settings.
- ▶ This symbol refers to an AUTO or SNGL filter (SNGL filter in LOCK mode), which is currently suppressing an identified feedback frequency.
- This symbol indicates that the AUTO and SNGL filters are in STOP mode. The settings already made remain active. However, “new” feedback frequencies are not eliminated.
- This symbol refers to the filter assigned to the last feedback frequency identified.

The selection and editing of parameters is largely the same as in the PEQ menu, one exception being the B key: With a long key press you can reset all filters (menu page 2) or just the AUTO filters (menu page 3).

3.3 WIDTH menu

The WIDTH function gives you a stereo imager for processing stereo signals and is active in stereo LINK mode only.

A signal whose stereo basis has been enlarged sounds much more interesting, because you can hear more pronounced differences between the two stereo sides. If used moderately, a stereo imager can clearly enhance the overall impression of your music.

On both pages of the WIDTH menu, the parameters to be edited appear on the right-hand side. On the left you’ll find the RESET IMAGE-function (B key), which allows you to undo the previously made entries by means of a long key press. In the center of the display, a diagram shows both the stereo width of the signal (triangle) and the mono signal (line).

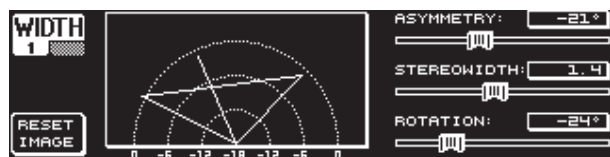

Fig. 3.11: WIDTH menu (page 1)

The parameter **STEREOWIDTH** offers a setting range from 0 to 3.0 (large data wheel), and defines how clearly the two sides of the stereo image are separated from each other.

With the upper data wheel you can edit the **ASYMMETRY** parameter and thus the relative volume of the left and right stereo signal, within a range from -90 to 90°, but without affecting the center mono signal. At 90 or -90° the left and right stereo sides overlap the mono signal, which means the stereo signal becomes a mono signal, too.

Use the **ROTATION** parameter (lower data wheel) to position the entire signal (stereo and mono) in the stereo image, without modifying the relative proportion between mono and stereo signals. This is useful, for example to position a single stereo signal in the overall mix ("true stereo" panorama setting).

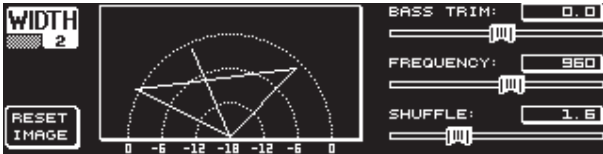

Fig. 3.12: WIDTH menu (page 2)

The second page of this menu provides functions for processing the sound of the signal. For example, **SHUFFLE** (lower data wheel) generates an additional stereowidth effect for the low-frequency range, because the signal separation between the left and right stereo sides is not so clearly audible in the bass as it is in the treble range. The spatial character of the sound becomes thus more intensive. The setting range is from 1.0 to 3.0.

BASS TRIM (upper data wheel) corrects the volume of the bass range by ± 3 dB and thus makes up for the effect generated by the SHUFFLE function with regard to the perceivable volume of the bass frequencies.

The **FREQUENCY** parameter (large data wheel) determines the cut-off frequency below which the SHUFFLE function processes (350 to 1,400 Hz). For normal stereo operation settings between 600 and 700 Hz usually sound best.

The parameters **ASYMMETRY**, **ROTATION** and **FREQUENCY** provide optional fine or coarse adjustment facilities (available by pressing the corresponding data wheels).

3.4 DYN menu

Your DEQ2496 offers a comprehensive set of dynamics processors for the optimization of audio signals. Two pages are available, on which you can adjust compressor and expander settings. An additional LIMITER function allows you to suppress signal peaks.

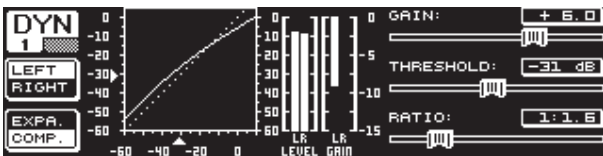

Fig. 3.13: DYN menu (page 1)

On the first page the B key lets you alternate between the compressor and expander functions. As in the other menus, the A key is used to alternate between the left and right stereo sides. In Stereo LINK mode all edits refer to both stereo sides.

Explanation:

A compressor reduces the volume level above a selected threshold and thus gives the sound more density and punch.

An expander reduces the volume level below a selected threshold and thus also reduces the levels of interference, such as tape noise or crosstalk. Extreme settings make an expander act like a noise gate, cutting off signal levels below the threshold completely.

The display is very much the same as in the DEQ menu, because here, too, signal processing depends on the volume level. On the right you'll find the edit parameters with the LEVEL meter for the DYN input signal next to them, the GAIN meter showing the amount of boost/cut applied and finally a graphic representation of the control curve.

The **GAIN** parameter (upper data wheel) corrects the volume of the compressed or expanded signal, within a range from -15 to +15 dB. As in the DEQ module, the **THRESHOLD** value (large data wheel) determines the point of onset, from which the compressor/expander starts processing the signal (0 to -60 dB). The **RATIO** parameter adjusts the amount of attenuation, once the signal exceeds or drops below the threshold (lower data wheel). The setting range is from 1:1.1 to 1:100.

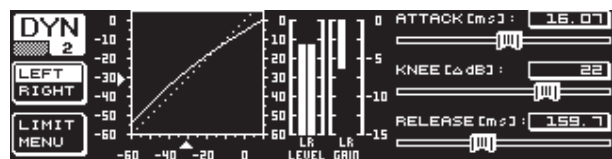

Fig. 3.14: DYN menu (page 2)

The PAGE or DYN key takes you to the second menu page, where you can adjust additional compressor/expander parameters.

Similarly to the DEQs, the upper data wheel adjusts the **ATTACK** time from 0 to 200 ms. The **RELEASE** time (20 to 4.000 ms) is set with the lower data wheel. Press the respective control to select a coarse or fine adjustment scale.

Compressor only:

The compressor features an additional **KNEE** function, which makes it possible to achieve a very unobtrusive and musical form of compression. The KNEE parameter controls the area around the threshold point, in which the compressor curve is "rounded out".

The KNEE setting range is from 0 to 30 dB and can be entered with the large data wheel.

A long key press on the B key resets the parameters on the dynamics pages, however, not the LIMITER settings (see next chapter 3.4.1).

3.4.1 LIMITER menu

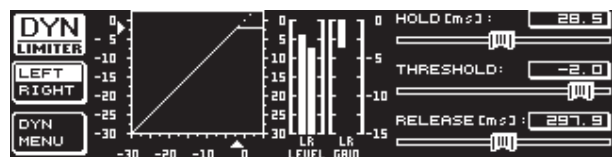

Fig. 3.15: LIMITER menu

On page 2 of the DYN menu, you can change to the **LIMITER** page with key B. In general, a limiter can be considered a compressor, however, one which always uses a maximum attenuation factor, thus effectively suppressing all signal peaks and protecting connected power amps and speakers from overload and possible damage. Here, too, the display shows how the signal is limited. Also available are a LEVEL meter (in this case displaying the output signal) and a GAIN meter showing the level reduction.

EN

The HOLD function determines how long the signal level is reduced, once the threshold has been exceeded (upper data wheel). Only when this time has expired (0 - 1,000 ms), will the RELEASE parameter take over. The control range of the THRESHOLD parameter (large data wheel) is from 0 to -24 dB, RELEASE can be adjusted between 20 and 4,000 ms (lower data wheel). A long key press on the B key resets the LIMITER parameters to their default values.

- ◆ The LIMITER function is always active and cannot be switched off. It is also active in bypass mode, however, only works to a limit value of 0 dB, so as to avoid digital distortion occurring on the outputs.

3.5 UTILITY menu

The UTILITY menu provides basic defaults settings (GENERAL SETUP) and MIDI configurations on two pages. The upper and lower data wheels select the parameters, which can then be edited with the large data wheel.

- ◆ When you keep the UTILITY key pressed for about 1 s, the ULTRACURVE PRO will be locked and cannot be accessed any longer (PANEL LOCKED). Keep the key pressed again to unlock the unit (PANEL UNLOCKED).

GENERAL SETUP (page 1)



Fig. 3.16: UTILITY menu (page 1)

CONTRAST

Here you can adjust the display contrast to adapt it optimally to studio/stage environments (large data wheel).

CHANNEL MODE

As already mentioned, you can choose between DUAL MONO and STEREO LINK mode. In DUAL MONO mode all settings for the left and right stereo sides can be entered separately. When you switch to STEREO LINK mode, the settings of one stereo side will be copied to the other. You can select whether the left side shall be copied to the right, or the right side to the left ("COPY LEFT -> BOTH" or "COPY RIGHT -> BOTH"). All subsequent editing will have an effect on both sides simultaneously. Finally, to activate one CHANNEL MODE, confirm your entry with the B key ("ACCEPT MODE").

GEQ MODE ("TRUE RESPONSE")

Due to the design of conventional equalizers there is always a difference between the adjusted frequency response curve and the resulting real frequency response. This difference depends on the frequency and the amount of boost/cut applied. Adjacent frequency ranges have a mutual influence on each other, so that the amounts of boost/cut in the individual frequency bands are added together.

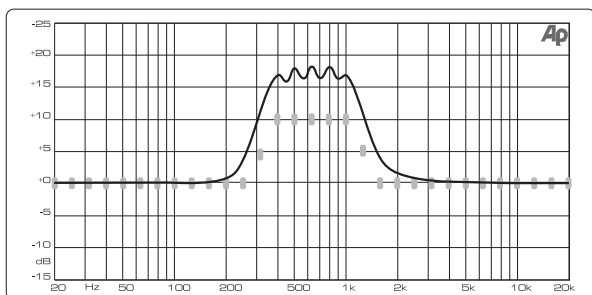

Fig. 3.17: Graphic equalizer without frequency response correction (UNCORRECTED)

The setting UNCORRECTED retains this mutual influence. With a specially developed algorithm the ULTRACURVE PRO can make up for this phenomenon. To use this characteristic, select TRUE RESPONSE.

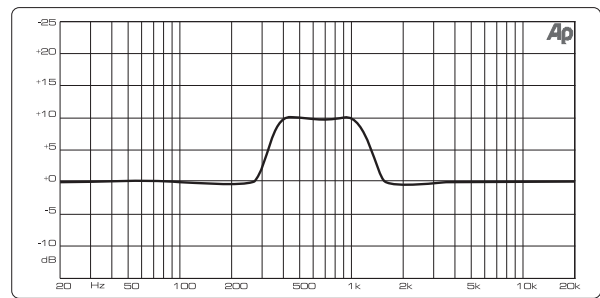

Fig. 3.18: Graphic equalizer with frequency response correction (TRUE RESPONSE)

The resulting real frequency response now corresponds exactly to the setting made with the graphic equalizer.

GAIN OFFSET (EQ)

Here, you can correct the overall gain of the EQ modules.

RTA NOISE CORRECTION

The algorithm used by the RTA (Real-Time Analyzer, "warped" FFT) leads to inaccuracies with wide-spectrum signals such as noise, due to the asymmetric overlapping of individual frequency ranges. When the built-in noise generator is on or the AVRG setting in the RTA menu has been selected, this correction will be made automatically, and needs not be switched on manually. With all other signals, however, this function should be off; otherwise, the individual frequency bands might be displayed incorrectly.

SHOW MESSAGE BOX

Here, you can determine whether the unit displays dialog windows or not.

RTA/MIC INPUT

Controls the input sensitivity of the RTA/MIC input. You can choose between LINE LEVEL, MIC LEVEL and MIC LEVEL +15 V (phantom power).

RTA/MIC LINE LEVEL

When the RTA/MIC input is set to LINE, this parameter determines the maximum input level (for 0 dBFS (full-scale) from -14 to +22 dBu).

RTA/MIC MIC LEVEL

When the RTA/MIC input is set to MIC, this parameter determines the sensitivity depending on the microphone connected (input sensitivity: -42 to -6 dBV/Pa).

MIDI SETUP (page 2)



Fig. 3.19: UTILITY menu (page 2)

The DEQ2496 can both transmit and receive MIDI data and thus works perfectly with other MIDI equipment.

MIDI

When this parameter is ON, you can display all subsequent MIDI configuration categories. When set to OFF, the DEQ2496 does not respond to any MIDI data.

MIDI CHANNEL

Here you can select the MIDI channel (1-16) on which the ULTRACURVE PRO transmits and receives MIDI data.

CONTROL CHANGE

The exchange of CONTROL CHANGE data refers to the GEQ module only (CONTROL CHANGE 1 - 31: left channel / CONTROL CHANGE 33 - 63: right channel).

PROGRAM CHANGE

PROGRAM CHANGE commands (both send and receive) are used to recall presets #1 to 64 as well as the default setting (preset #0: INITIAL DATA).

SYSTEM EXCLUSIVE

Your DEQ2496 can both transmit and receive sys-ex data (system exclusive).

The transmission/reception of MIDI data can be enabled or disabled specifically (ON/OFF). To be able to receive software updates, RECEIVE SYSTEM EXCLUSIVE must be ON.

DUMP EDIT (A key)

This function allows you to transfer active settings via MIDI to another ULTRACURVE PRO or a computer equipped with a MIDI interface.

DUMP ALL (B key)

The complete memory contents (all presets) of the ULTRACURVE PRO can be transferred via MIDI to another ULTRACURVE PRO or a computer equipped with a MIDI interface.

⚠ **Caution: the reception of the complete memory contents from another unit will overwrite all existing settings! All saved presets will be retained.**

⚠ **More information on MIDI can be found in chapter 5.1 "MIDI connections" and 7.1 "MIDI implementation".**

3.6 I/O menu

On the first three pages of this menu you can determine the input/output configuration, while the fourth page allows you to adjust the output signal delay function, for example to make up for run-time differences, which occur when several P.A. speaker stacks set up at a distance from each other are used.

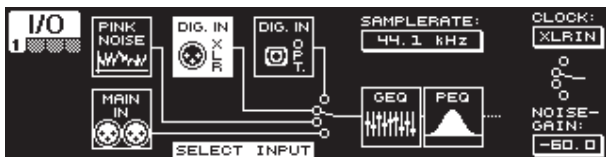

Fig. 3.20: I/O menu (page 1)

On the first page you can select the DEQ2496's input source with the large data wheel. You can choose between the analog MAIN INPUT, the digital inputs (DIGITAL XLR or DIGITAL OPT) and the built-in PINK NOISE generator. Use the **NOISE GAIN** parameter to adjust the volume level of the noise generator (lower data wheel). The setting range is from -60 to 0 dB. The upper data wheel controls the sample rate (**CLOCK**) used by the device. When the digital input has been selected, the sample rate cannot be changed, because the DEQ2496 tracks the sample rate contained in the input signal. When the PINK NOISE generator is on, the modules DEQ and DYN (not LIMITER) are switched off.

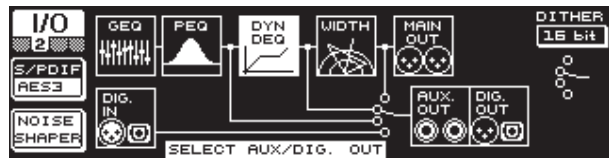

Fig. 3.21: I/O menu (page 2)

On the second menu page you can determine the signal source for the AUX output and the digital outputs. Selectable options are the unprocessed input signal (MAIN IN or DIG. IN), the processed signal, post-graphic/parametric EQ (BEHIND GEQ/PEQ), the processed signal post-EQ and post-dynamics module (DYN), or the processed signal post-all modules, i.e. post-stereo imager (BEHIND WIDTH).

Use the A key to select the consumer format (**S/PDIF**) or the professional digital format (**AES/EBU**). The upper data wheel controls the resolution, **DITHER** (OFF, 24-bit, 20-bit and 16-bit). The **NOISE SHAPER** function to be activated with the B key reduces the dither-induced noise by moving it to a frequency range where it is less audible.

⚠ **If the connected sample rate does not correspond to the rate adjusted on the DEQ2496, this field shows the message UNLOCKED, which mutes all outputs of the DEQ2496.**

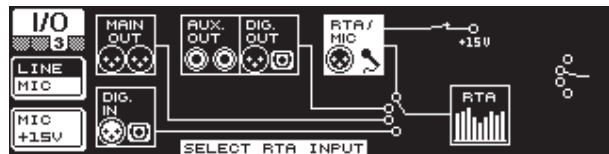

Fig. 3.22: I/O menu (page 3)

On the third page you can determine the input signal for the real-time analyzer. Selectable options are MAIN IN (or DIG. IN), MAIN OUT, AUX OUT/DIG. OUT (XLR and optical) and RTA/MIC input. When you select the RTA microphone input, the A key switches the input sensitivity from MIC to LINE, and vice versa, while the B key enables or disables the phantom power supply required for condenser microphones (MIC +15 V), if the input sensitivity has been set to MIC.

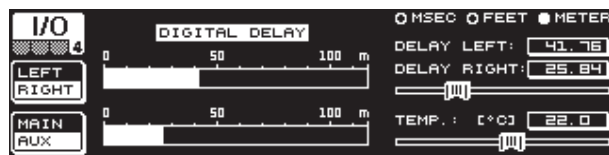

Fig. 3.23: I/O menu (page 4)

On the fourth page of the I/O menu, the ULTRACURVE PRO DEQ2496 allows you to delay either the MAIN output signal or the AUX signal, which is useful, for example, when the connected speakers are positioned at a distance from each other, which results in audible run-time differences and/or phase cancellation.

With the A key you can select the left or right stereo side. Independently of the Stereo LINK mode both sides can be processed separately. Keep the key pressed to edit both sides simultaneously. The B key determined whether the MAIN or AUX output signal is processed. Keep this key pressed to reset all delay settings.

With the upper data wheel you can determine the unit for the delay settings. You can choose between milliseconds (0 - 300 ms), feet (0 - 338.08 ft) or meters (0 - 103.08 m). If feet or meters have been selected, the lower data wheel adjusts the current ambient temperature in °Fahrenheit or °C, so as to ensure an optimum delay response pattern (**TEMP.**). This is necessary because the speed of sound largely depends on the ambient temperature. For example, at 20 °C ambient temperature, the speed of sound is 343.6 m/s. The higher the temperature, the higher the speed of sound (plus 0.6 m/s per °C).

EN

Depending on the channel selected, the large data wheel now controls the left or right stereo side of the output signal (**DELAY LEFT** and **DELAY RIGHT**) or even both at the same time. Press the wheel to select a coarse or fine adjustment scale.

- ◆ The **AUX** output allows you to send out both the delayed and the undelayed signal. This way, you can set up a delay line without any additional equipment (see also chapter 4.4).

3.7 BYPASS menu

The BYPASS menu includes one page, on which you can select various BYPASS parameters for making comparisons between different sound settings.

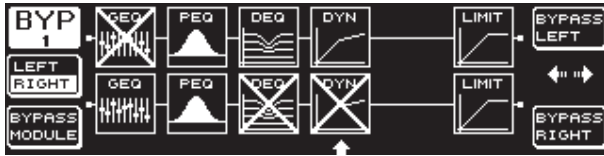

Fig. 3.24: BYPASS menu

In DUAL MONO mode you can activate the relay bypass function for the left (upper data wheel: **BYPASS LEFT**) or right stereo side (lower data wheel: **BYPASS RIGHT**). This connects the analog left or right input of the unit to the corresponding analog output, so that the signals bypass the modules completely. In STEREO LINK mode the upper and lower data wheels disable the modules of both sides simultaneously, so that only the unprocessed input signal can be heard (**BYPASS ALL**).

- ◆ Keeping the **BYPASS** key pressed in **DUAL MONO** or **STEREO LINK** mode activates the bypass relays of both channels.

Turn the large data wheel to select individual modules, and press it to remove them from the signal path. The same can be achieved by pressing the B key (**BYPASS MODULE**). Keeping this key pressed for a while will reset all BYPASS settings. Keeping the module keys pressed for a while (**GEQ**, **PEQ** etc.) will enable/disable the bypass function for individual modules.

- ◆ Please note that the **WIDTH** function (stereo imager) is not available in **DUAL MONO** mode, and is therefore not displayed in the **BYPASS** menu.

3.8 RTA menu (Real-Time Analyzer)

Your ULTRACURVE PRO DEQ2496 features an FFT real-time analyzer for the graphic representation of all frequency ranges (61 bands). Additionally, this menu includes an **AUTO EQ** function (AEQ) for automatic frequency response correction (see chapter 3.8.1).

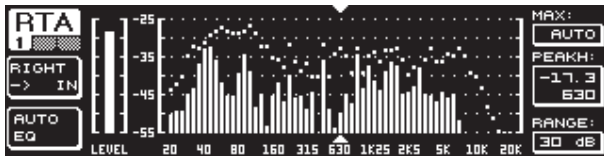

Fig. 3.25: RTA menu (page 1)

On the first page, the A key selects the analyzer input signal. These settings are the same you can adjust on page 3 of the I/O menu. You can choose between the options **MAIN IN** or **DIG IN (L + R IN)**, **MAIN OUT (L + R OUT)**, **AUX. OUT/DIG. OUT (L + R DIGOUT)** and **RTA IN (MIC/LINE)**. Use the A key for selection. Keep the key pressed to determine which input signal is displayed by the analyzer (left, right or complete input signal—not available if **RTA IN** has been selected).

RTA MIC/LINE IN displays the signal present at the RTA/MIC input (see chapter 3.11).

The **MAX.** parameter (upper data wheel) allows you to select an “excerpt” of the entire level spectrum, depending on the actual magnitude of the signal level. The adjusted dB value (0 to -60 dB) refers to the upper limit that will be displayed. Press the wheel to activate the **AUTO** function. Now the **MAX** value is adjusted automatically, depending on the signal level. **RANGE** (lower data wheel) determines the dynamic range displayed in four steps (15, 30, 60 or 90 dB). Depending on the selected **MAX** value, the dynamic range displayed will be extended towards the bottom end.

LEVEL or **PEAKH** (large data wheel) allow you to select specifically each of the 61 frequency bands and display their current volume levels (**LEVEL**) or **PEAK** values referenced to the adjusted frequency. The cursor arrows above and below the graphic indicate the currently selected frequency range. The level of the main signal is shown by the **LEVEL** meter to the left of the RTA display.

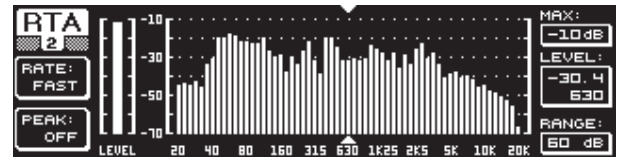

Fig. 3.26: RTA menu (page 2)

On the second page of the RTA menu you can adjust the release time in four steps (**FAST**, **MID**, **SLOW** and **AVRG**) with the A key (**RATE**). If set to **FAST**, **MID** or **SLOW**, the RTA uses peak detectors. If set to **AVRG**, it calculates average values from the signal levels. In this mode, the analyzer seems to be processing slower than usual. The B key (**PEAK**) selects in five steps how fast the displayed signal peaks disappear again (**FAST**, **MID**, **SLOW**, **HOLD** and **OFF**). If set to **HOLD**, the maximum values of the individual frequency bands are “frozen”. If you press the B key for about 1 s, the “frozen” level peaks are reset and can be calculated anew.

- ◆ If **PEAK** is set to **HOLD**, the name of the **LEVEL** parameter changes to **PEAKH**.

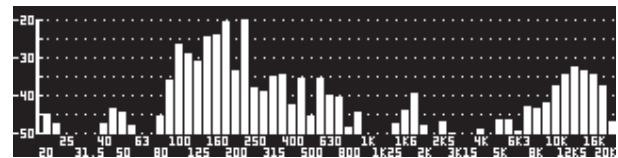

Fig. 3.27: RTA menu (page 3)

If you wish to display the RTA in a larger format, please go to page 3, where the illustration covers the whole display. All the other functions available on page 2 can still be edited (**RATE**, **PEAK**, etc.).

3.8.1 3.8.1 AUTO EQ function (AEQ)

The RTA menu (page 1) also includes an **AUTO EQ** function, which allows you to analyze and correct the frequency response automatically. This module is subdivided into three additional pages. Please note that for the **AEQ** function to work you must connect a measuring microphone to the **RTA/MIC** input (see chapter 3.11).



Fig. 3.28: AEQ menu (page 1)

In terms of setup and functionality page 1 is identical to the **GEQ** menu (see chapter 3.2.1). You can determine the desired frequency response manually, onto which the automatic frequency response correction of the input/output signals shall be based. Once the curve of your choice has been set up, please switch to the second page of the **AEQ** menu.

- ◆ When you activate the AEQ menu, the current GEQ settings will be taken over and used as the desired frequency response curve.

Press the large data wheel to exclude individual frequency bands from the AEQ mode. These bands will not be processed by the automatic frequency response correction. It makes sense to exclude the low-frequency range (up to approx. 100 Hz) from AUTO EQing, because it is this range that may produce inaccuracies during the calculation of the frequency response, which might impair the results achieved with the AUTO EQ.

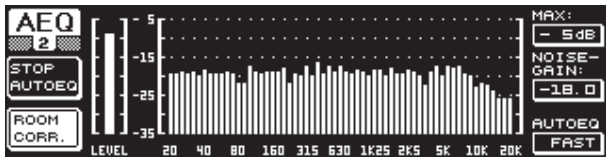

Fig. 3.29: AEQ menu (page 2)

On this page the signal to be processed is displayed as in the RTA menu. The **MAX.** parameter lets you select an “excerpt” of the entire level spectrum, depending on the actual magnitude of the signal level (upper data wheel). The **RANGE** value is firmly set to 30 dB. Press the upper data wheel to activate **AUTO** mode, which automatically adjusts the displayed “excerpt”, depending on the signal level. With the **NOISE GAIN** parameter (-60 to -10) you can adjust the magnitude of the noise level. **AUTO EQ** (lower data wheel) determines the speed at which the EQs are analyzed and their settings are calculated. You can select between the settings **FAST**, **MID** and **SLOW**.

The **B** key activates the room correction function (**ROOM CORR.**), which cuts the high frequencies and boosts the low-frequency range by “tilting” the desired response curve by 1 dB/oct.

When you press the **A** key (**START AUTO EQ**), the analyzer starts measuring and calculating the AEQ settings. The subsequent messages inform you that the unit analyzes the level of the ambient noise at first, before it measures the noise signal applied. Subsequently, the ULTRACURVE PRO corrects the EQ values. Press **STOP AUTO EQ** to cancel this process.

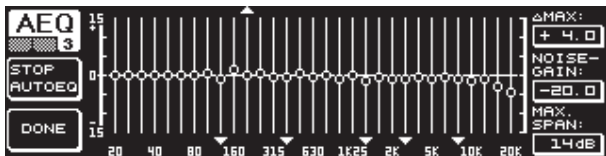

Fig. 3.30: AEQ menu (page 3)

Page 3 of this menu shows the graphic EQ with the settings adjusted on page 1. Here, too, you can **START AUTO EQing** and change the **NOISE GAIN** parameter (large data wheel). However, this page includes two additional parameters: Δ **MAX** adjusts the maximum difference between two adjacent filters from 0 to +15 dB (large data wheel), while **MAX. SPAN** (lower data wheel) controls the maximum distance allowed between the desired and real frequency response curve (0 to 30 dB). When this value is exceeded, the corresponding range will not be processed. Press the **B** key (**DONE**) to complete this process and keep the adjusted curve. Press the **RTA** key to cancel. Please note the **AUTO EQ** does not automatically terminate the analyzing process.

- ◆ After leaving the first page of the AEQ menu, there is no way of returning to this page, but by leaving the entire menu and recalling it again.

3.9 MEMORY menu

In the **MEMORY** menu you can save and recall complete presets (page 1) or load and save individual modules (page 2). Modules that are active within a preset are marked by a letter (**G** = GEQ, **P** = PEQ, **D** = DEQ, **W** = WIDTH, **Y** = DYN). If the stored I/O settings differ from the current ones, an **I** (=I/O) will appear next to the letter indicating the module.

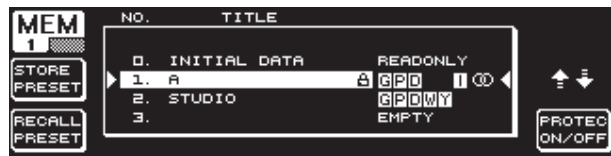

Fig. 3.31: MEMORY menu (page 1)

On the first page of this menu, you can save and recall complete presets. To save a previously edited preset please use the large data wheel to select a memory location from the table shown (max. 64 user locations).

- ◆ Preset #0 (**INITIAL DATA**) is a neutral default setting which cannot be overwritten (**READONLY**).

You can either select an **EMPTY** memory location or overwrite an existing preset, as long as it is not write-protected (**PROTEC ON**). After selecting a memory location, press the **A** key to store the preset (**STORE PRESET**).

- ◆ When you try to overwrite an existing preset and press the **A** key, the DEQ2496 will prompt you to confirm your overwrite command (**OVERWRITE DATA?**). Press the **A** key to **CANCEL**, or the **B** key (or press the large data wheel) to confirm (**OK**).

After pressing **STORE PRESET** another menu will appear in which you can name the preset (max. 16 characters). With the data wheel (turn) and the upper data wheel (turn and press), you can select the characters both horizontally and vertically. Press the center data wheel to enter a character, subsequently the cursor in the lower entry field will be moved to the next position. Turn the lower data wheel to select individual positions and press it to erase individual characters. When you keep the wheel pressed for about 1 s, all characters will be erased. The **PAGE** key determines whether selected characters will be overwritten (**OVR**) or new ones be inserted (**INS**). Confirm (**OK**) or **CANCEL** with the **A** or **B** key respectively.

To recall an existing preset, just select it as usual with the large data wheel, and confirm by pressing the wheel or the **B** key (**RECALL PRESET**). You will then be prompted to confirm the command, because this will erase the settings of the currently selected preset—as long as it has not been saved before (**RECALL ALL DATA?**). Confirm (**OK**) or **CANCEL** with the **A** or **B** key respectively. You can also continue the process by pressing the large data wheel. Subsequently, the preset of your choice will be loaded.

- ◆ The **MEMORY LED** lights up as soon as the settings of the preset selected in the **MEMORY** menu have been edited and thus differ from the current settings.
- ◆ Presets set to stereo **LINK** mode are marked by a stereo symbol (\odot) in the preset chart.

Press the lower data wheel for a while to lock or unlock the selected preset (**PROTEC ON/OFF**), which prevents accidental overwriting. Locked presets are marked with a lock symbol.

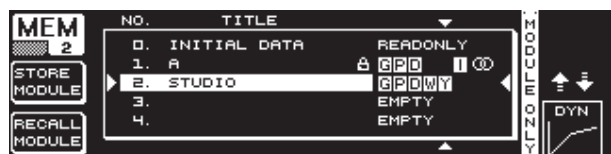

Fig. 3.32: MEMORY menu (page 2)

EN

To load individual modules from an existing preset, please press the PAGE key to go to the second page of the MEMORY menu. Similar to page 1, you can select a preset from which you want to load a module. Turn the lower data wheel to select the module of your choice (GEQ, PEQ, DEQ, WIDTH, DYN and I/O). Then, press the large data wheel or the B key to load the module (**RECALL MODULE**). Here, too, you will be prompted to confirm your selection.

Additionally, **STORE MODULE** (A key) allows you to store individual modules in an existing preset.

Exception:

DUAL MONO modules cannot be stored in a STEREO preset.

3.10 METER menu

The **METER** key below the two 7-digit LED displays selects the METER menu comprising three pages and giving you an overview of all input/output levels of the DEQ2496.

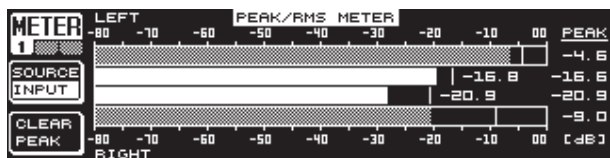

Fig. 3.33: METER menu (page 1)

Page 1 of the METER menu shows the levels of the left and right stereo side. Use the A key (SOURCE) to determine whether the input signal, the output signal or the signal applied to the digital or AUX output shall be displayed. The two bars in the middle of the display show the average level of the signals in the form of a VU meter. This means that the displays respond with some delay to changes in signal level. Thus, very short peaks will not be displayed (RMS).

The outer two displays are peak meters indicating the signal level including all peaks. As a consequence, the levels shown here are always a bit higher than those displayed by the VU meter. The signal peaks of all level meters (including peak hold) are shown to the right of these displays (**PEAK**). Press the B key (**CLEAR PEAK**) to reset the peak values and recalculate them.

♦ If the input/output signal overloads, the corresponding LEVEL meter will read "CLIP" (PEAK). In this case, reduce the input/output level.

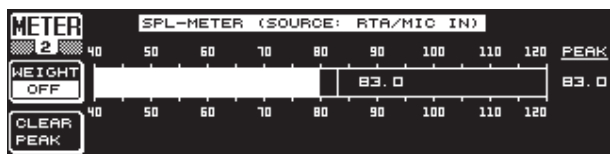

Fig. 3.34: METER menu (page 2)

The SPL meter (Sound Pressure Level) can be found on page 2 of this menu. In combination with a measuring microphone (e.g. BEHRINGER ECM8000), this meter allows you to measure volume levels. SPL also features a peak hold display, and with the B key you can reset and recalculate the peak value (**CLEAR PEAK**).

♦ The correct setting of the microphone sensitivity must be ensured (see chapter 3.11). We recommend our measurement microphone BEHRINGER ECM8000, which features an input sensitivity of -37 dBV/Pa.

The A key (**WEIGHT**) adjusts various dB weighting routines for the calculation of the signal level (dB (A), dB (C) or OFF).

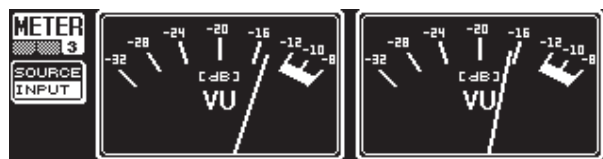

Fig. 3.35: METER menu (page 3)

Page 3 of the METER menu provides a virtual VU meter, as known from analog processors or mixing consoles.

3.11 RTA/MIC input

Use this input to feed a microphone or line signal (separate from the main input) into RTA or SPL meter. Information on how this is done is found on page 1 of the UTILITY menu.

3.11.1 Connecting a measurement microphone

Select MIC LEVEL as input sensitivity on RTA/MIC. If you are using a condenser mic, you need to activate phantom power (MIC LEVEL +15 V). On RTA/MIC MIC LEVEL, adjust the sensitivity of the mic you are connecting. If you are using the BEHRINGER ECM8000, this value is -37 dBV/Pa.

3.11.2 Connecting a line signal

Select LINE LEVEL as input sensitivity on RTA/MIC INPUT. Adjust the desired input sensitivity under RTA/MIC LINE LEVEL. The preset value is 0 dBFS or 120 dB SPL.

4. Applications

The universal concept of the BEHRINGER ULTRACURVE PRO with its multitude of audio processing functions opens up a whole range of applications. A few examples with typical settings will be described in the following.

4.1 Sum-signal equalizer for live applications

This application is the most probable use of the ULTRACURVE PRO.

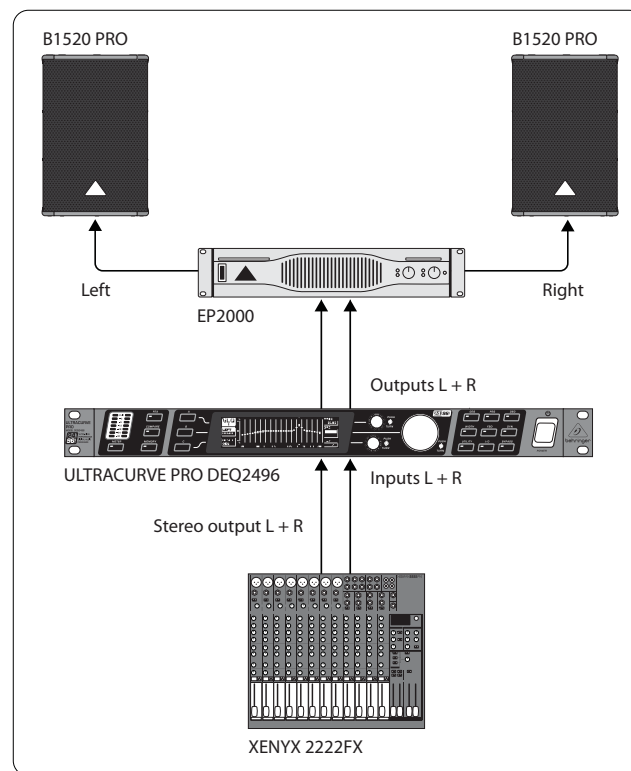

Fig. 4.1: The ULTRACURVE PRO as sum-signal equalizer

Please observe a few points to achieve optimum results:

Before you start equalizing the frequency response of your audio system, we recommend that you listen to “uncorrected” music and speech material, which has proven useful in practice: If distortion occurs, it is liable to be caused by the system and should be eliminated there.

The setup of the speaker stacks is also important. No equalizer can substantially improve a sound that is “muddied” by reflections from the ceiling and the walls of the room. Often, experiments with the speaker setup and orientation allow for dramatic improvements.

In a multi-way system you should also eliminate run-time and phase differences before equalizing the system (our digital frequency crossover ULTRADRIVE PRO DCX2496 provides all functions required for this purpose).

Now it's the turn of the DEQ2496. The automatic analyzing routine (AEQ) helps you find an acceptable basic setting. Make sure that the measurement microphone is positioned correctly. It should be located in the direct field of radiation of the system, and any negative acoustic circumstances should be eliminated. It is of no use to place the microphone behind a curtain, less than one meter away from side or rear walls, or on an open balcony, as this would deteriorate the measuring results. Background noise must be at least 12 dB below the measuring level to ensure valid measurements.

Once the system has been analyzed automatically with the AEQ, the resulting basic setting allows you to fine-tune the system.

Please note:

A linear frequency response curve is not ideal for all applications. For example, for speech transmission intelligibility is the key. As a consequence, the curve should be increasingly flat towards the low-frequency range, because here the human voice produces nothing but interference (rumble noise).

Extremely low and high frequencies are usually reproduced with considerably less energy. There is no point in “forcing” a small full-range speaker box to reproduce a frequency response well below 50 Hz. The best result you can get is the need for more power—and more money for repairing the speakers.

◆ **Whenever you set up your audio system, please always take account of its physical limits.**

If time permits, make several measurements with the measurement microphone at different positions.

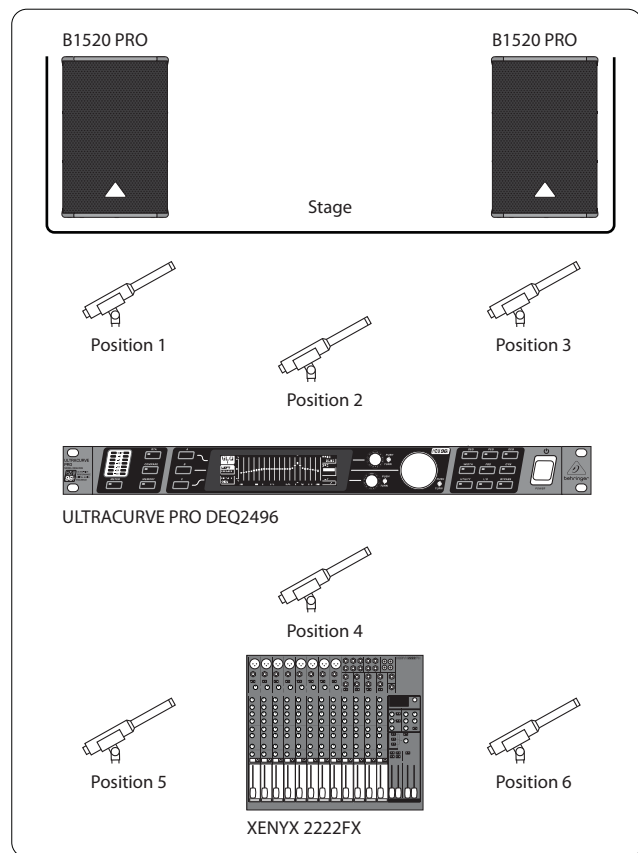

Fig. 4.2: Positioning the measurement microphone

Positions 1 and 3 are approx. 1 m on-axis in front of the speakers, about half the distance between midrange and tweeter systems. These measurements are used to verify the functioning of all loudspeakers. Position 2 is located about 2 m in front of the center of the stage. The measurement should yield roughly the same result above 250 Hz as the measurements made at positions 1 and 3. Below 250 Hz, the summing of the low-frequency range should result in a level boost of approx. 3 dB.

Position 4 is located directly in front of the FOH mixing console. The curve measured here should be the same as at position 2, however, with a lower level due to the greater distance.

Positions 5 and 6 are on-axis again, this time, however about 1 meter before the rear wall of the room. These measurements will reveal any problems with reflections or stationary waves.

Please store and subsequently compare the resulting equalizer curves. Major differences between the stored settings are most likely caused by phase errors in the system or problems with the room acoustics. If you cannot eliminate these problems, you have no other choice but to find the best compromise possible. A comparison with the stored equalizer curves will be very helpful.

Once the system has been set up as precisely as possible to reproduce the desired transmission curve, you should walk around in the listening area to get an impression of how the system sounds at the various positions. Remember to make a break between your listening tests and to use different music or speech programs to get a feel for the system's sound and the room acoustics.

Good equalizer settings need both time and patience! If extreme settings are required to achieve a usable frequency response, this should warn you of some serious problems either in the system or the room acoustics.

Equalizers cannot solve the problems caused by poor audio systems, but can be very useful and efficient tools for musical fine-tuning. This, in turn, allows for often surprising improvements in terms of acoustic transparency and the overall sound quality of sound reinforcement systems.

4.2 Equalizer in the monitor path

The use of the ULTRACURVE PRO in the monitor path follows the same basic rules as the sum-signal equalizer application described above. Additionally, the DEQ2496 offers a few features that are particularly useful for monitoring purposes.

The Feedback Destroyer helps you identify and eliminate feedback frequencies during sound check. Once a specific feedback frequency has been found, it can be eliminated by assigning the corresponding filter to it in SINGL mode. If hand-held (i.e. wireless) microphones are used, the acoustic conditions will be changing all the time. In this case, it is useful to set the Feedback Destroyer filters to automatic search mode (AUTO). The Feedback Destroyer is suited only for those signal paths that carry heavily modulated signals only (speech, vocals, drums). In principle, there is no way to distinguish long-sustaining sine tones produced for example by a synthesizer or flute from feedback. Here, the result would be the unwanted elimination of such sounds. If all automatic filters are already in use suppressing feedback, and a new feedback frequency is found, the first filter used will be released and set to the new frequency. The Feedback Destroyer can work no miracles, but it can increase the feedback immunity of the audio system by a few dBs. Whenever it responds, you should consider this a warning to reduce the volume level on stage.

Basically, the on-stage volume level should be kept as low as possible, because:

1. it will be easier on your hearing,
2. there are less feedback problems, and
3. it's easier to achieve a good P.A. sound.

Often, the volume of the monitor speakers is raised as a concert goes on. Use breaks and pauses to reduce all monitor paths by about 3 dB. The musicians will not or hardly hear that the volume has been reduced, because during a break their hearing can relax a bit. This gives you valuable headroom in your system. If you use certain speaker types on a regular basis, you can save standard settings on your equalizer, which have proven useful in practice (e.g. for 15" wedge or drum-fill speakers). Extremely low frequencies are usually faded out completely to avoid a "muddy" sound on stage caused by low-frequency feedback.

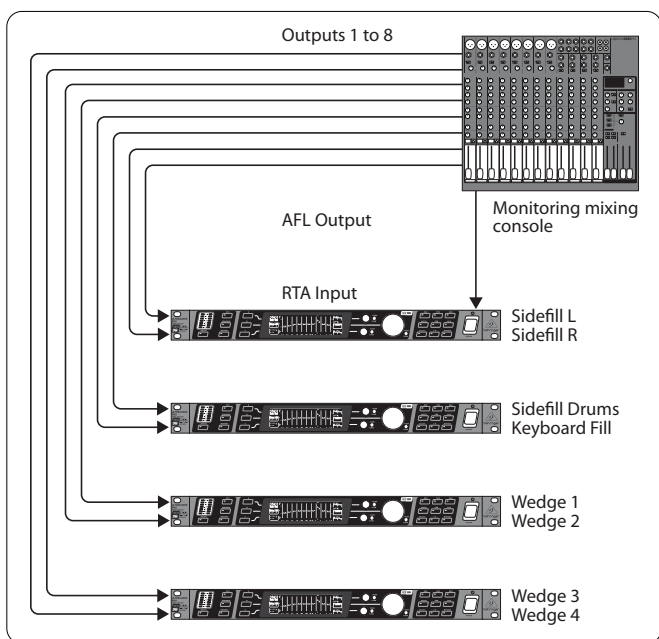

Fig. 4.3: Several ULTRACURVE PROs in a monitor system

Figure 4.3 shows an example of using several ULTRACURVE PROs in a 8-way monitor system. The AFL output of the monitor console (usually feeding the control speaker at the monitor console) can alternatively be connected via the RTA/MIC input. On the DEQ2496, select the RTA input in the RTA menu to display the signal of the currently active monitor path.

4.3 Using the ULTRACURVE PRO in the studio

The number of possible uses for your DEQ2496 in a studio environment is endless. Your imagination is the only limit. Here are just a few examples:

As an equalizer for the monitor speakers: apart from the usual graphic equalization (GEQ) the parametric filters (PEQ) can be used efficiently to suppress narrow-band room resonance. What is more, the DEQ2496 functions as an A/D and D/A converter for the conversion of analog to digital, and vice versa.

As a mastering equalizer: Owing to the stereo link function all settings on the graphic equalizer must be made only once. Here, too, the additional parametric filters can be used effectively for fine-dosed equalization. Use the AES/EBU inputs/outputs (optional) for sound processing purely in the digital domain.

For general sound shaping: The option to change programs via MIDI and modify all parameters via MIDI controllers makes the ULTRACURVE PRO a particularly flexible tool if combined with a MIDI sequencer. For example, this allows you to change settings during mix-down and still have them reproducible all the time.

4.4 Using the ULTRACURVE PRO as a delay unit

Apart from the applications described in chapter 4.1, it also happens that speaker stacks must be set up at a larger distance from the stage to produce some direct radiation at remote positions. In order to make up for the run-time differences between the on-stage speakers and the remote stacks, the latter must be provided with an electronically delayed signal. Usually, special delay lines are used for this, however, not so with the DEQ2496, because it already includes a signal-delay option. This function can be operated as conveniently as on any dedicated device. The delay setting is stored with a program, and by using the MAIN and AUX outputs you need only one DEQ2496 to set up a delay line: simply delay one of the output signals and send it to the remote speaker stacks.

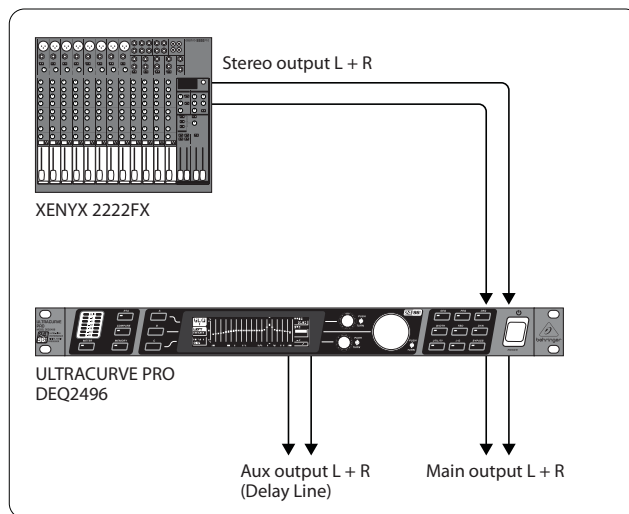

Fig. 4.4: Run-time correction in a sound reinforcement system using the ULTRACURVE PRO

5. Connections

5.1 MIDI connections

Your DEQ2496 incorporates a MIDI interface, which allows you to send and receive MIDI data. It is thus possible to integrate the unit into a recording studio and control it from a computer-based sequencer program.

The MIDI connectors on the rear of the unit are internationally standardized 5-pos. DIN jacks. You need commercially available MIDI cables to connect the ULTRACURVE PRO to other MIDI equipment.

MIDI IN: receives MIDI control data. Adjust the receive channel in the UTILITY menu.

MIDI THRU: the MIDI THRU jack allows for passing on incoming MIDI signals without modification, for example, to daisy-chain several ULTRACURVE PROs.

MIDI OUT: sends MIDI data to a connected computer or another ULTRACURVE PRO. Transmitted formats are program data and status information for signal processing.

5.2 Analog connections

As a standard feature, the BEHRINGER ULTRACURVE PRO DEQ2496 has electronically balanced inputs and outputs. The circuit design features automatic hum and noise reduction for balanced signals and allows for trouble-free operation, even at highest operating levels. Externally induced mains hum, etc. is thus effectively suppressed. The servo function, which is also automatic, recognizes the connection of unbalanced pin assignments and changes the nominal level internally so that there is no difference in level between the input and output signals (6 dB correction).

⚠ Please ensure that only qualified persons install and operate the device. During installation and operation the user must have sufficient contact to earth. Electrostatic discharges might affect the operation of the unit.

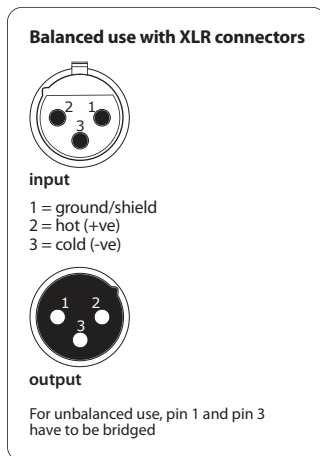

Fig. 5.1: XLR connectors

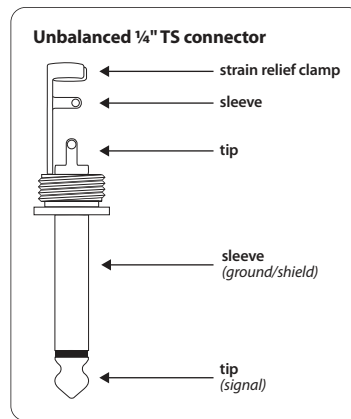

Fig. 5.2: 1/4" TS connector

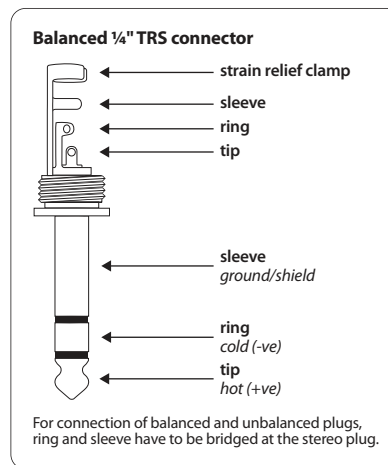

Fig. 5.3: 1/4" TRS connector

5.3 Digital connections (AES/EBU and S/PDIF)

The AES/EBU interface whose name is derived from the Audio Engineering Society and the European Broadcasting Union, is mainly used in professional studio environments and broadcasting studios for the transmission of digital signals, also over greater distances. The connection is made via balanced XLR cables with a wave resistance of 110 ohms. Cables can be up to 100 m long. With some minor adaptations, even cable lengths of over 1 km are possible (not rare in radio and TV applications).

The interface complies with the AES3 format, which allows for the two-channel transmission of signals with a resolution of up to 24 bits. The signal has an auto-clock and auto-synchronization feature (important when several digital devices are used). An additional wordclock connection between DEQ2496 and connected AES/EBU equipment is therefore not required. The sample rate is not fixed and can be chosen freely. Typical rates are 44.1 kHz, 48 kHz, 88.2 kHz and 96 kHz. The AES/EBU interface is largely compatible to the popular S/PDIF interface. A connection can be made using an adapter. On the ULTRACURVE PRO the format can be switched to S/PDIF.

Digital inputs/outputs on optical connectors are also available.

5.4 WORDCLOCK connection

If several devices shall be embedded into a digital recording system comprising, for example, a digital mixing console, all connected digital devices must be synchronized using a common wordclock signal. To this end, your DEQ2496 features a wordclock input, which can be used to control external equipment via wordclock signals. The input supports the sample rates 44.1, 48, 88.2 and 96 kHz, and can be activated only if the analog inputs are used.

6. Operating Software

The operating software of your ULTRACURVE PRO DEQ2496 is constantly being developed to improve its performance and adapt the operation of the unit to user requirements. We would therefore be pleased to hear about your suggestions and ideas for improvement. We will try to include your suggestions in the next software revision. Information on new software versions are available from the trade press, your retailer, from our web site at behringer.com or directly from BEHRINGER (Tel. +49 2154 9206 4166).

The current software revision of your ULTRACURVE PRO DEQ2496 is displayed in the UTILITY menu on page 1 (top right).

7. Specifications

Analog Inputs

Type	electronically balanced
Connector	XLR
Impedance	22 k Ω at 1 kHz
Max. input level	+12 or +22 dBu, switchable
CMRR	40 dB typ.

Analog Outputs (Main)

Type	servo-balanced
Connector	XLR
Impedance	100 Ω at 1 kHz
Max. output level	+12 or +22 dBu, switchable

Analog Outputs (Aux)

Type	servo-balanced
Connector	¼" stereo jack
Impedance	100 Ω at 1 kHz
Max. output level	+12 dBu

System Specifications

Frequency range	10 Hz to 35 kHz (-1 dB) @ 96 kHz sampling rate
Signal-to-noise ratio	> 113 dB main input/output > 107 dB aux output
THD	0.007 % typ. @ +4 dBu, 1 kHz, unity gain
Crosstalk	< -92 dB/-95 dB

Bypass

Type	Relay, hard-bypass in case of power failure
------	---

Measurement Microphone Input

Type	electronically balanced
Input impedance	2 k Ω
Max. input level (LINE)	variable from -14 dBu to +22 dBu
Max. input level (MIC)	variable from -42 dBV/Pa to -6 dBV/Pa
Phantom power	+15 V, switchable

Digital Input 1

Type	XLR transformer-balanced
Standard	AES/EBU or S/PDIF
Input impedance	110 Ω
Nom. input level	0.2 - 5 V peak-to-peak

Digital Input 2

Type	TOSLINK optical
Standard	AES/EBU or S/PDIF

Digital Output 1

Type	XLR transformer-balanced
Standard	AES/EBU or S/PDIF
Impedance	110 Ω
Output level	3.5 V peak-to-peak

Digital Output 2

Type	TOSLINK optical
Standard	AES/EBU or S/PDIF

Sync Input

Type	BNC
Standard	Wordclock (1 x sample rate)
Input impedance	50 k Ω
Nom. level	2 - 6 V peak-to-peak

MIDI Interface

Type	5-pole DIN jacks In/Out/Thru
Implementation	cf. MIDI implementation chart

Digital Processing

Converter	24-bit Delta-Sigma, 64/128-oversampling (AKM [®])
Sample rate	44.1, 48, 88.2, 96 kHz

Graphic Equalizer (GEQ)

Type	digital 1/3-oct EQ
Frequency range	20 Hz to 20 kHz, 31 1/3-oct. bands according to ISO frequencies
Bandwidth	1/3-oct.
Control range	+15 to -15 dB

Parametric Equalizer (PEQ)

Type	max. 10 independent, fully parametric filters per channel
Frequency range	20 Hz to 20 kHz
Bandwidth	1/10 to 10 oct., shelving filters (6 and 12 dB)
Control range	+15 to -15 dB

Dynamic Equalizer (DEQ)

Type	max. 3 independent, fully parametric filters per channel
Frequency range	20 Hz to 20 kHz
Bandwidth	1/10 to 10 oct., shelving filters (6 and 12 dB)
Control range	+15 to -15 dB
Threshold	variable from 0 to -60 dB
Attack	0 to 200 msec
Release	20 to 4,000 msec
Ratio	1:2 to 1:100

Feedback Destroyer (FBD)

Type	digital signal analysis for feedback identification
Filter	max. 10 digital notch filters per channel, programmable or as automatic feedback suppression system
Frequency range	20 Hz to 20 kHz
Bandwidth	1/10 to 1/60 oct.
Control range	0 to -60 dB

Digital Delay

Type	digital stereo delay
Max. delay time	300 ms, independently adjustable for each channel
Min. resolution	0.02 ms
Delay units	seconds, meters or feet

Level Meter

Type	digital level meter with simultaneous graphic display of peak and RMS values and virtual analog VU meter
------	--

SPL Meter

Weighting	dB (A), dB (C) or OFF
Microphone calibration	-42 dBV/Pa to -6 dBV/Pa

Dynamics

Type	Expander or compressor with digital IGC (Interactive Gain Control)
Threshold	variable from 0 to -60 dB
Attack	0 to 200 msec
Release	20 to 4,000 msec
Ratio	1:1.1 to 1:100

Limiters

Type	Peak limiter (zero attack)
Hold	0 to 1,000 msec
Threshold	variable from 0 to -24 dB
Release	20 to 4,000 msec

Real-Time Analyzer

Type	digital 61-band FFT analyzer
Frequency range	20 Hz to 20 kHz, 61 bands according to ISO frequencies
Detectors	peak and average
Noise generator	pink noise, levels from 0 to -60 dB

Display

Type	320 x 80 dot-matrix LC display
Backlighting	LED, orange
Contrast	adjustable

Memory

Presets	64 memory locations with 16-character names, single modules can be recalled and saved
---------	---

Power Supply

Mains voltage	85 to 250 V~, 50/60 Hz
Power consumption	10 W typ.
Fuse	T 1 A H
Mains connector	Standard IEC receptacle

Dimensions/Weight

Dimensions (H x D x W)	44.5 x 482.6 x 215 mm (1.75 x 19 x 8.5")
Weight	approx. 2.24 kg (4.9 lbs)
Shipping weight	approx. 3.09 kg (6.8 lbs)

BEHRINGER is constantly striving to maintain the highest professional standards. As a result of these efforts, modifications may be made from time to time to existing products without prior notice. Specifications and appearance may differ from those listed or illustrated.

7.1 MIDI implementation

Function	Send	Receive	Notes
Midi Channel	1 ... 16	1 ... 16	
Mode	N	N	
Note Number	N	N	
Velocity	N	N	
After Touch	N	N	
Pitch Bender	N	N	
Control Change			
1-31	Y (Range: 0-61)	Y (Range: 0-61)	GEQ Left (20 Hz ... 20 kHz)
33-63	Y (Range: 0-61)	Y (Range: 0-61)	GEQ Right (20 Hz ... 20 kHz)
Program Change	Y (Range: 0-64)	Y (Range: 0-64)	Presets (1-64) and Initial Data (0)
System Exclusive	Y	Y	see SysEx-Documentation*
System Common	N	N	
System Real Time	N	N	

* Download at behringer.com

FEDERAL COMMUNICATIONS COMMISSION COMPLIANCE INFORMATION



Responsible Party Name: **MUSIC Group Services US Inc.**
Address: **18912 North Creek Parkway,
Suite 200 Bothell, WA 98011,
USA**
Phone/Fax No.: **Phone: +1 425 672 0816
Fax: +1 425 673 7647**

ULTRACURVE PRO DEQ2496

complies with the FCC rules as mentioned in the following paragraph:

This equipment has been tested and found to comply with the limits for a Class B digital device, pursuant to part 15 of the FCC Rules. These limits are designed to provide reasonable protection against harmful interference in a residential installation. This equipment generates, uses and can radiate radio frequency energy and, if not installed and used in accordance with the instructions, may cause harmful interference to radio communications. However, there is no guarantee that interference will not occur in a particular installation. If this equipment does cause harmful interference to radio or television reception, which can be determined by turning the equipment off and on, the user is encouraged to try to correct the interference by one or more of the following measures:

- Reorient or relocate the receiving antenna.
- Increase the separation between the equipment and receiver.
- Connect the equipment into an outlet on a circuit different from that to which the receiver is connected.
- Consult the dealer or an experienced radio/TV technician for help.

This device complies with Part 15 of the FCC rules. Operation is subject to the following two conditions:

- (1) this device may not cause harmful interference, and
- (2) this device must accept any interference received, including interference that may cause undesired operation.

Important information:

Changes or modifications to the equipment not expressly approved by MUSIC Group can void the user's authority to use the equipment.



We Hear You